



ПРОМЫШЛЕННЫЙ ДИЗАЙН



ТРАНСПОРТ

ART DECO

ЖЕЛЕЗНАЯ ДОРОГА



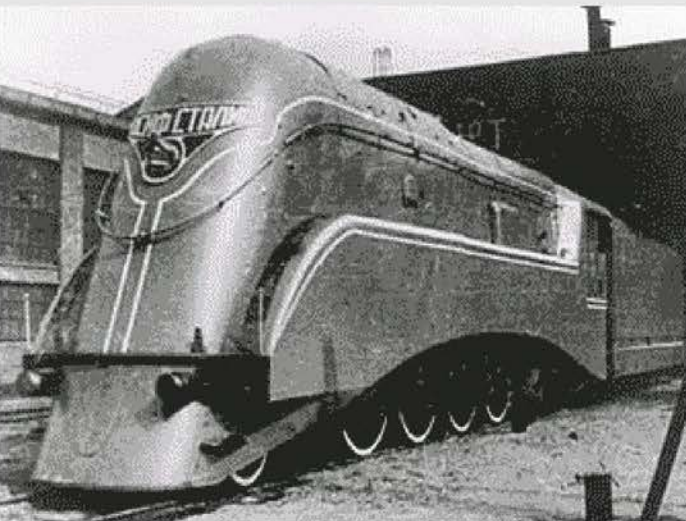
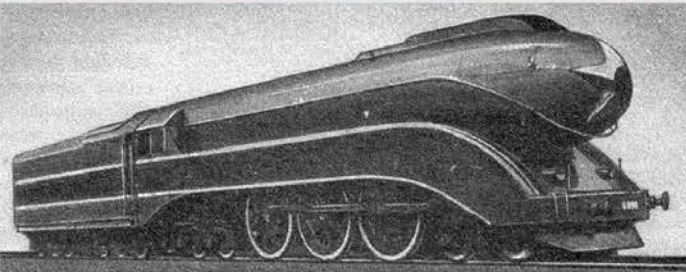







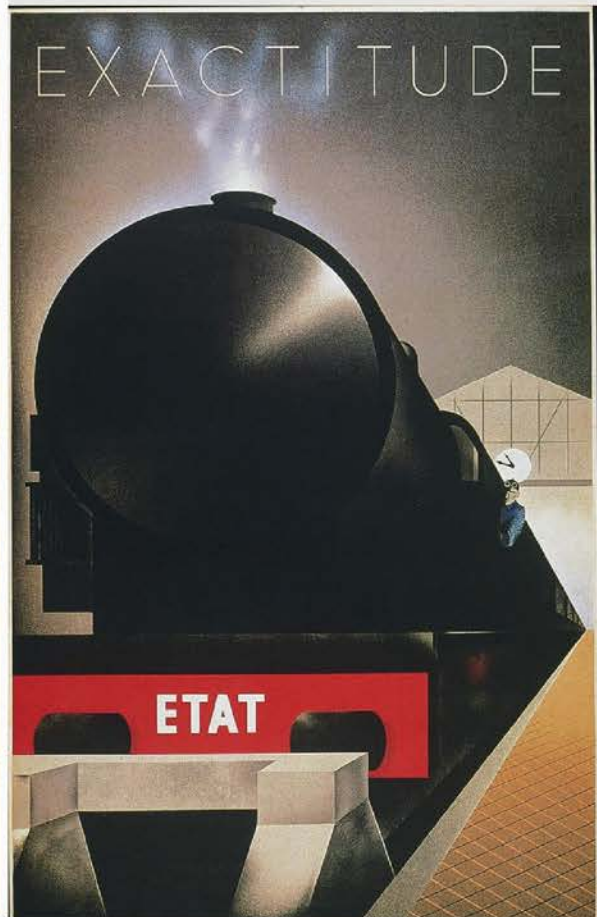



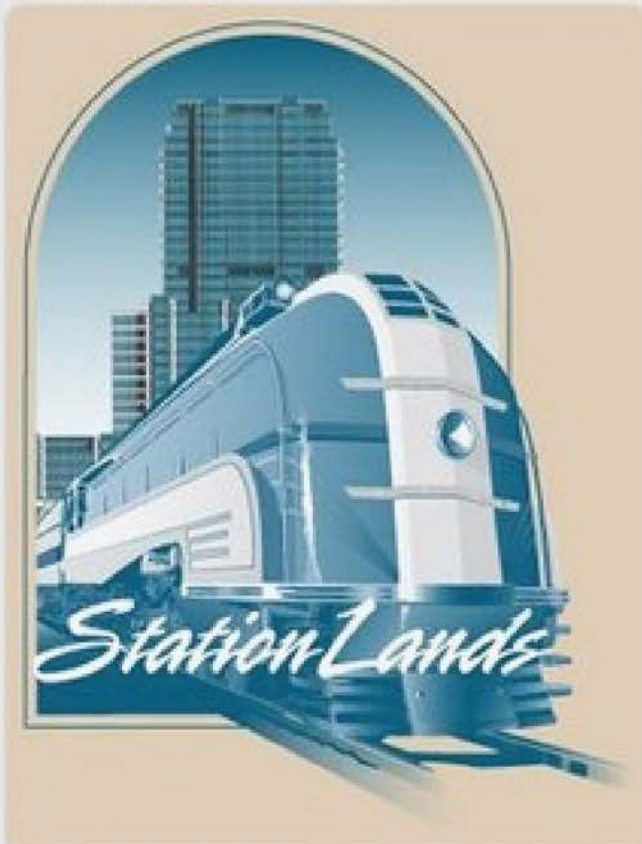
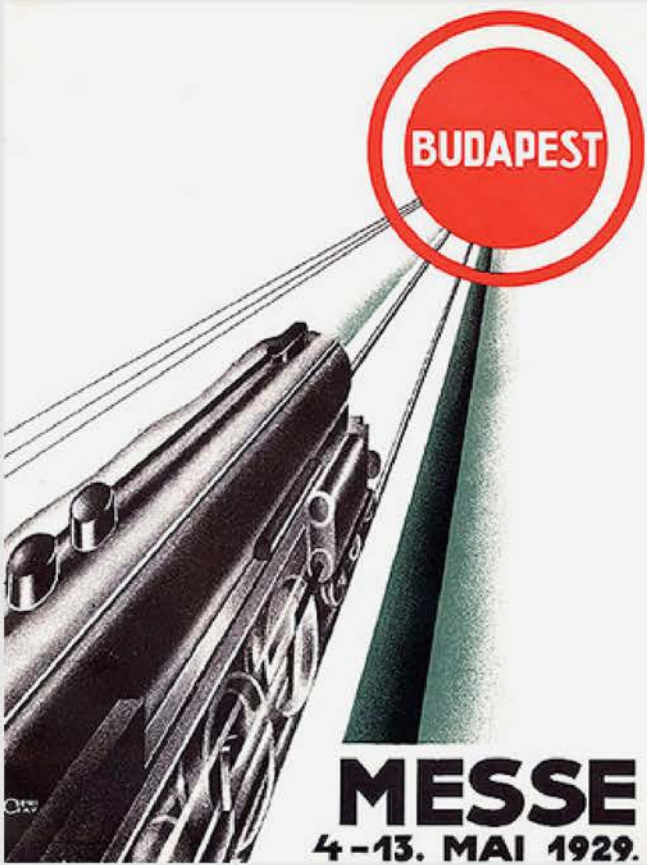

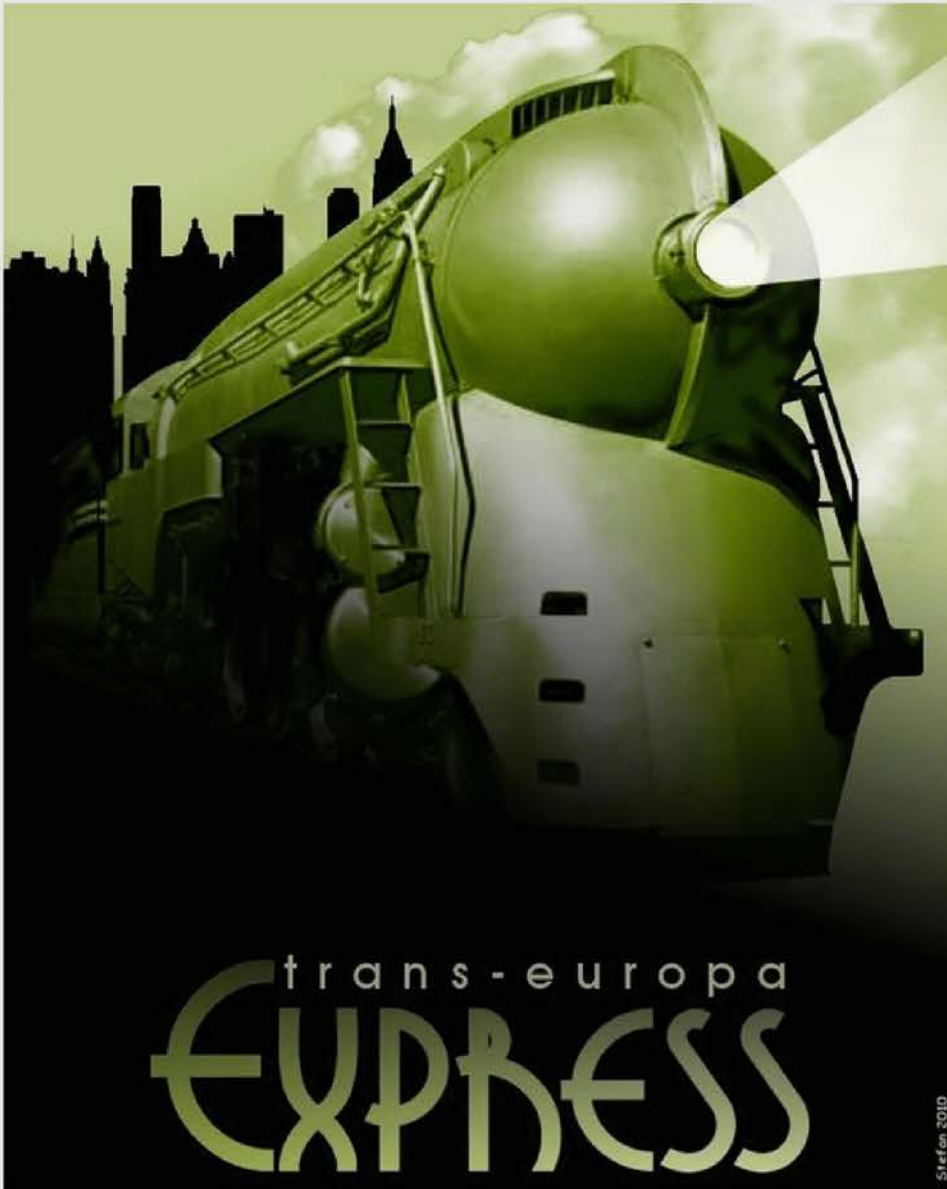

АВИАЦИЯ И ВОЗДУХОПЛАВАНИЕ



ДИРИЖАБЛИ



THE GRAPHIC

AN ILLUSTRATED WEEKLY NEWSPAPER

1895

No. 481—Vol. LV.
Registered in U.S. Postoffice

SATURDAY, JULY 15, 1895

THIRTY-TWO CENTS [PER ANNUM \$16.00]



MOVING THROUGH THE GAZARD IN THE CAR AT THE CASERNA IN THE MARCHING MILES
IN THE CAPTIVE BALLOON AT SARAS COURT
DRAWN BY HENRI LAYON.

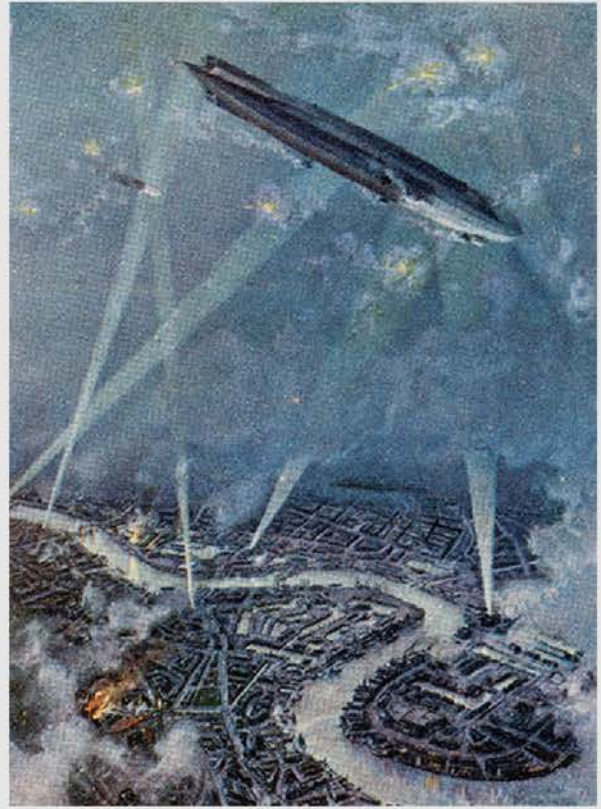
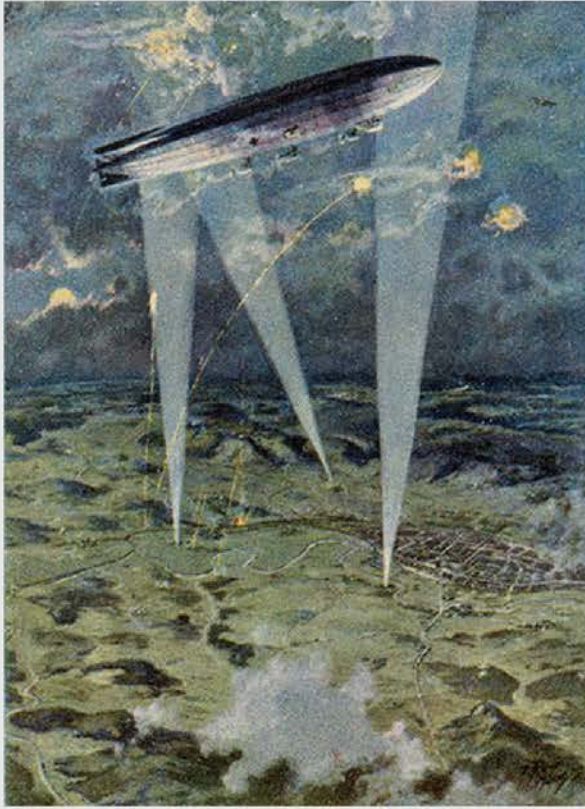

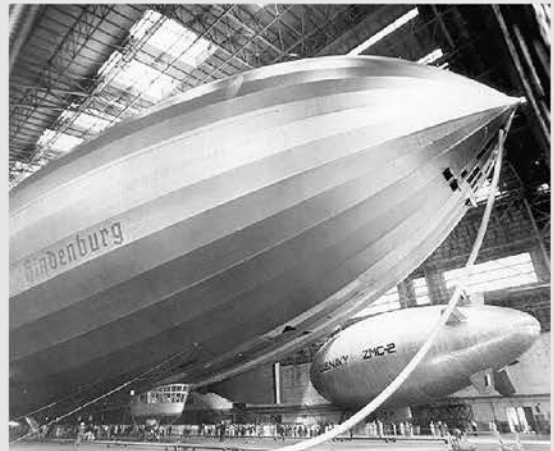
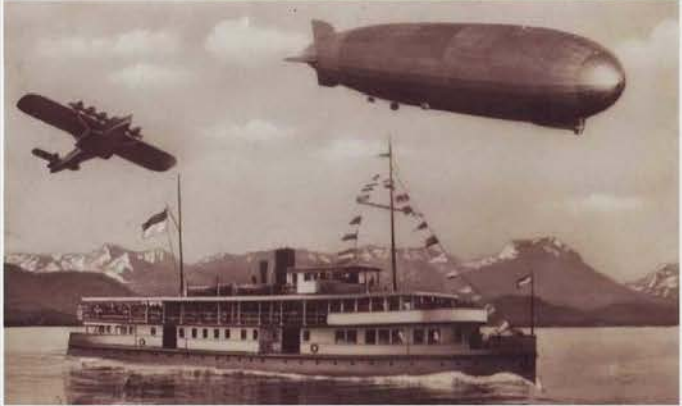

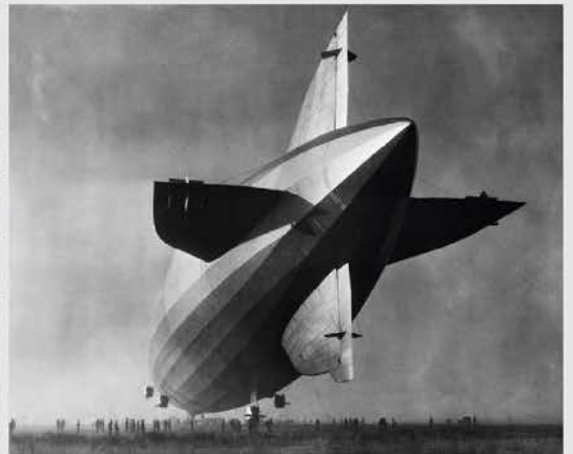

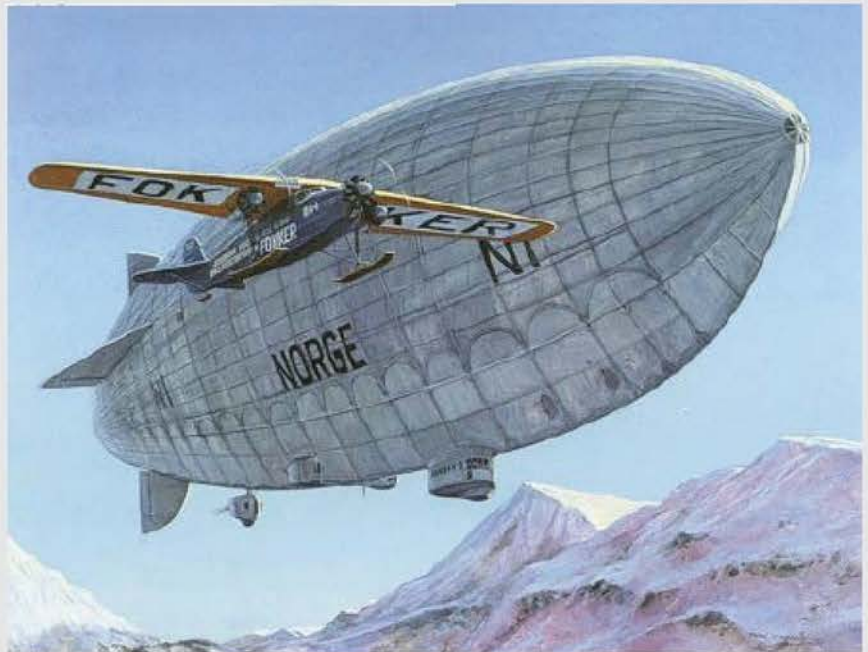
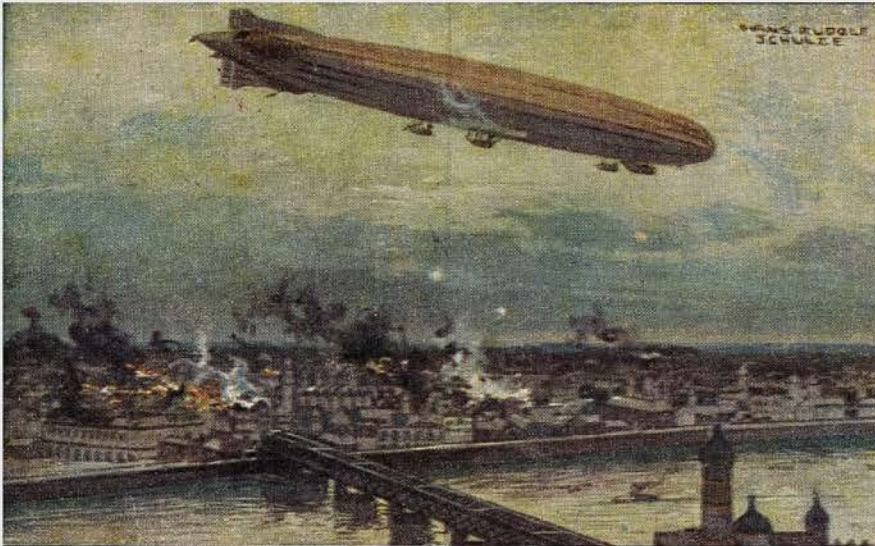

102.—Empire State Building, New York.



EMPIRE STATE BUILDING BY MOONLIGHT, NEW YORK

Building Provides Mooring Masts for Zepps



NEW YORKERS may soon become accustomed to the sight of giant lighter-than-air liners moored to the tops of downtown skyscrapers, for the Empire State Building, now under construction at 34th Street and Fifth Avenue, when completed will be topped by a mooring mast of the latest type.

This new building, which will rise to a height of 1483 feet will top the Eiffel Tower of Paris by 174 feet and will be the tallest structure in the world. It is planned to make this building the western terminal of trans-Atlantic airships.

Fast Burning Tear Gas Candle
THE successful use of tear gas in quelling prison riots has resulted in great interest by police authorities in this chemical agent which does its work without causing injury. The Chemical Warfare Service at the army, as a result of requests for a tear gas device that will produce a gas cloud immediately of high concentration, recently has shipped to Governors Island, New York, two dozen of the new universal fast burning tear gas candles for test there.

These candles were developed in order to meet the demand for a tear gas weapon that will produce an effective gas concentration so quickly that a riot will be made helpless immediately. The fast burning candles are used in the same manner as a grenade but differ from the latter in that they have a larger capacity, and the tear gas is generated with almost explosive violence. Thus the gas gets into the air with no delay and in great volume.

The older grenades were somewhat slow in ignition and the gas was generated slowly. The fast burning candle ignites so rapidly after having the kind that by the time it hits the ground it is giving off its fumes in great quantities. The test of these candles will be watched with great interest not only by the army but by civil authorities, who agree that tear gas is a most effective and humane method of quelling disturbances.

Inventions for August



This composite photograph shows how the Graf Zeppelin compares with Empire State building.

Oval Auto Cylinders Cut Length

AN automobile engine has been built in England with elliptical cylinders, the idea being to save length, the narrow way of the cylinders being placed in a fore-and-aft position. Thus a 344% cylinder would be equivalent to a 2% round cylinder but take no more length than one 3 inches in diameter.

127



АВИАЦИЯ





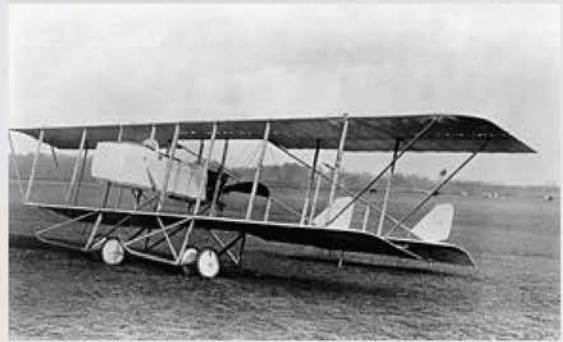

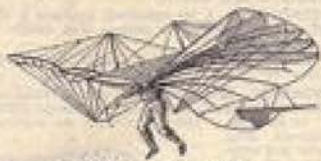

Planer Léonard (1890)



Aéro d'Adre (1887)



Planer Quatre (1897)



Planer Forber (1894)



Biplan Wright (1907)



Biplan Voisin (1908)



Monoplan Bleriot (1909)

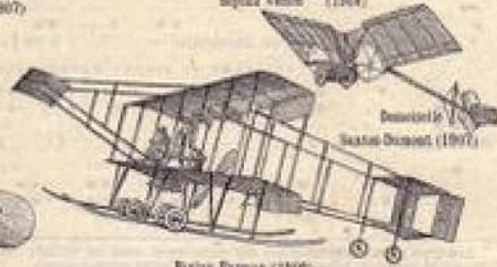

Biplan Farman (1908)

Démontable
Léonard Dumont (1907)



Monoplan Rebiakoff (1908)



Biplan Goussier à moteur (1917)



Monoplan Bay (1914)

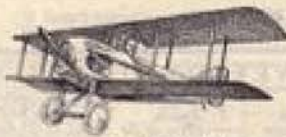

Biplan Spad (1918)



Biplan Sopwith (1918)



Biplan Nieuport (1916)



Biplan Nieuport (1917)



Monoplan Kormos Székely (1919)

Biplan Spad Northover (1918)



Triplan Caproni (1921)



Amiot-Beriot (1920)



Intérieur d'un aéroplane grand (1920).
La cabine des voyageurs.



En l'air.

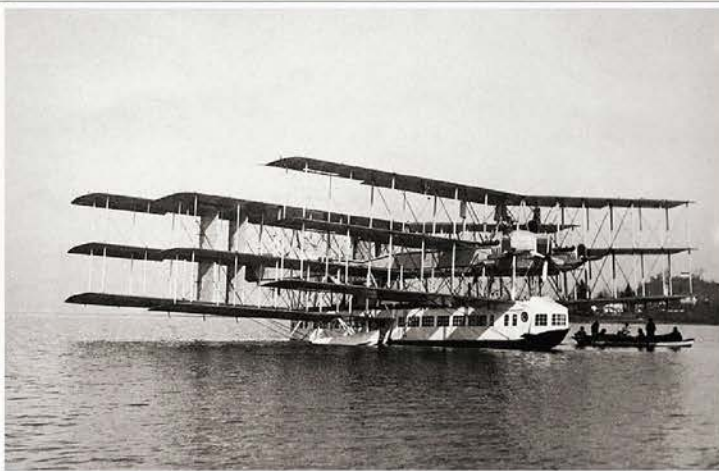

Советская авиация

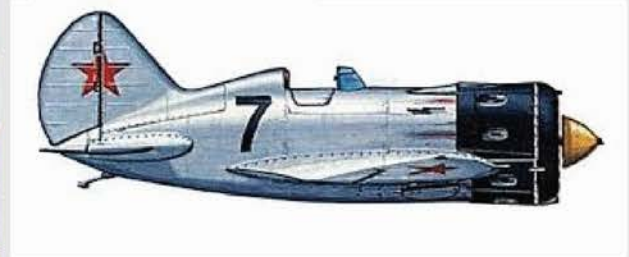

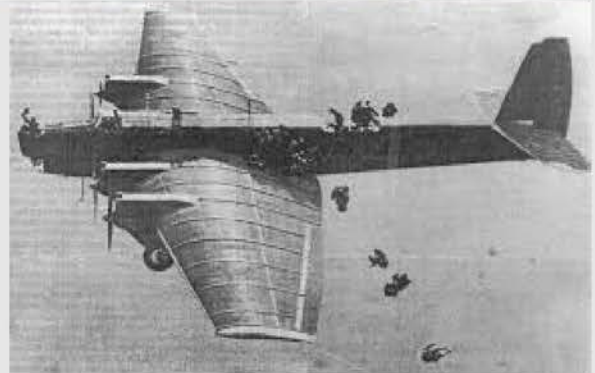

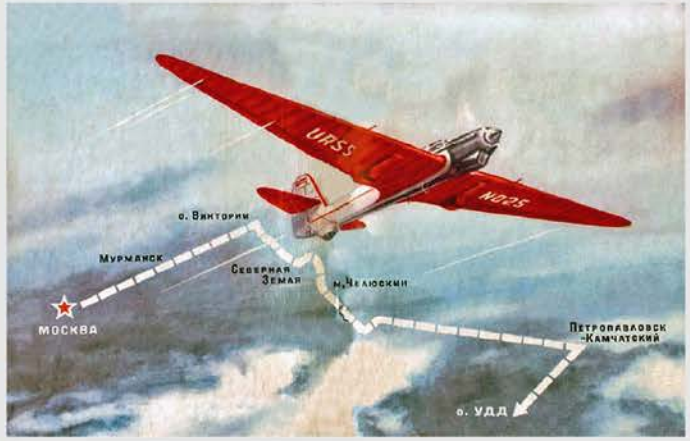

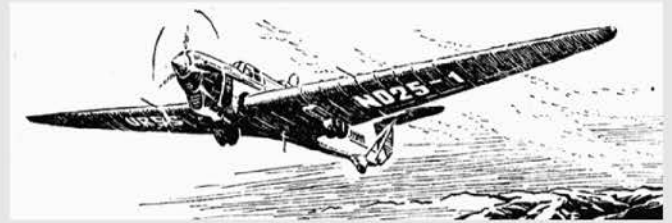





Advertisement

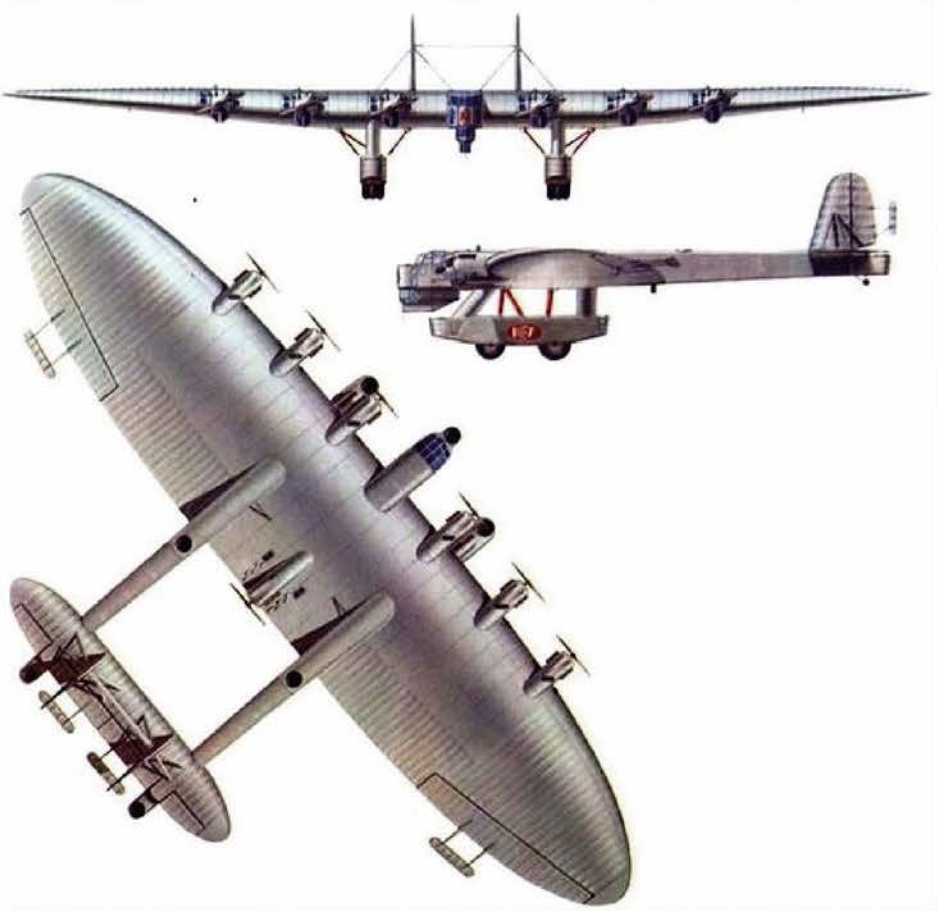



№-1 №2134, 395 мм 230 мм.
№-1 М.А. Калачов, лето 1943 г.



№-16 «Ирмиски»-303 мм.
Александр Калачов, лето 1943 г., Родня Де Ла Пуэла



№-1 ВВС ЮВ, 1942 г.



№-1 №0447, 21 мм ВВС ВВФ, №-1 Заларов, март 1942 г.



№-1 ВВС ЮВ, Александр Герасимовский и др., 1942 г.



№-1 В ил ВВС ЮВ, Селезнев, осень 1942 г.











Гражданская авиация



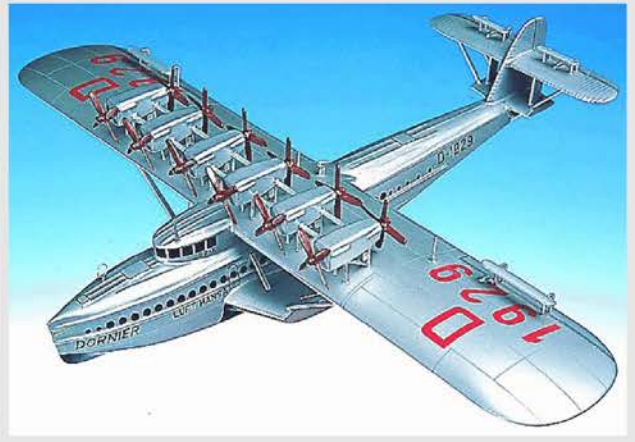



Мода на авиаторский стиль



ЖЕНЩИНА-ПРОЛЕТАРКА.

ОВЛАДЕВАЙ АВИАЦИОННОЙ ТЕХНИКОЙ

ИДИ В ШКОЛЫ, ТЕХНИКУМЫ, ВТУЗЫ ГРАЖДАНСКОГО ВОЗДУШНОГО ФЛОТА!

КИМ

МНОЖИТИ ПИТАКИ ТА АВІО-КАДРИ

КЛАСОВИ ОБРАЗОВИ ВСЬОГО ЧЕРВОЦНАПОРНОГО КОМСОМОЛУ

SAMOLJOT BIR SART UCQRAN JOLNI KARVAN BIR KUN, HAFTA VA BIR AJLAB JURADI.

ГДЕ САМОЛЕТ ПРОЛЕТАЕТ ЧАСЫ, КАРАВАНЫ ИДУТ ДНИ, МЕСЯЦЫ, МЕСЯЦЫ!

SPECIAL! 4.98

Warm Winter Coats at Christmas Sale Prices!

FRONT QUARTER HORSEHIDE ...Guaranteed 2 YEARS!

- PRICE CUT \$1.00.
- HEAVY MOLESKIN.
- SELECTED SHEEPSKIN PELTS.
- WOMBÓ COLLAR.
- LEATHER REINFORCED POCKETS.
- SPECIAL PURCHASE BEFORE THE RISE.
- LIMITED QUANTITY.

SALE PRICE \$5.89

NO CARRYING CHARGE

NO MONEY DOWN ON ORDERS OVER \$5

GENUINE HORSEHIDE
 The popularity leader! Reduced \$1.00 for this sale! For sports, work and general wear! Cut full and heavy! Heavy of best quality Front Quarter Horsehide! One piece front and back! Zipper closing matches all work. Warm Wool Mole skin lining. Adjustable cuffs. Guaranteed 2 yrs. Size: 36 to 46 chest. Length: 27 in. Color: Black. No. G29827 \$8.95

"ZIPPER" CLOSING
 Christmas sale special! Deeply cut collar! Popular coonack style! Heavy of XXX Genuine Hockmeyer Corduroy (saves for long wear). Super warm, back without sheepskin lining. Large Wombó styled hand pockets. Genuine leather reinforced pockets. Double breasted. Knit wool vesting. Double breasted. Full 24 in. long. Color: Navy Blue. No. G29828 \$8.69

HOCKMEYER CORDUROY
 Worth much more on today's market! A gift he'll appreciate! UK Heavy Genuine Hockmeyer Corduroy (saves for long wear). Super warm, back without sheepskin lining. Large Wombó styled hand pockets. Genuine leather reinforced pockets. Double breasted. Knit wool vesting. Double breasted. Full 24 in. long. Color: Navy Blue. No. G29828 \$7.48

SHEEPLINED HORSEHIDE
 Quality, warmth and appearance impossible to duplicate anywhere at this low price! —Cut \$1.00 for this sale! Of super-durable XX Selected Front Quarter Horsehide lined with heavy, super-warm selected sheepskin pelts! Guaranteed 2 yrs. Heavy Wombó styled hand collar. Double breasted. Full 24 in. long. Color: Black. No. G29829 \$15.95

POPULAR COSSACK STYLE
 Give him a practical gift this year! He'll appreciate this unusually excellent quality. XXX Selected Genuine Suede Leather. Warm more than anything else. It's worth much more than this low sale price! Russian style made collar. Full quality water lining. Adjustable cuffs and straps at sides of "self" waistband. Size: 36 to 46 chest. Colors: Green or Reindeer Brown. No. G29830 \$7.75

XXX HEAVY SUEDE
 A dandy gift! Cut priced! Smart, warm, heavy Suede jacket with heavy Tabor inner lining. Warm break or join, exclusive all wool, and slippers all handker with buttons. Fine, snug-fitting wool, wadded waistband. One-piece front and back—a sign of high quality. Substantiated for greater warmth. Adjustable cuffs. Size: 36 to 46 chest. Colors: Reindeer or Cacao Brown. No. G29831 \$8.39

30-03 Coats and Blazers You'll Be Proud to Wear or Give—No Added Cost for Credit—Spiegel's, Chicago

SHORTEST ROUTE

Coast to Coast

TWA

The Lindbergh Line

TRANSCONTINENTAL & WESTERN AIR Inc.

908

От гоночных самолетов к истребителям









КОРАБЛИ И ПАРОМЫ



ΠΑΡΟΜΥ

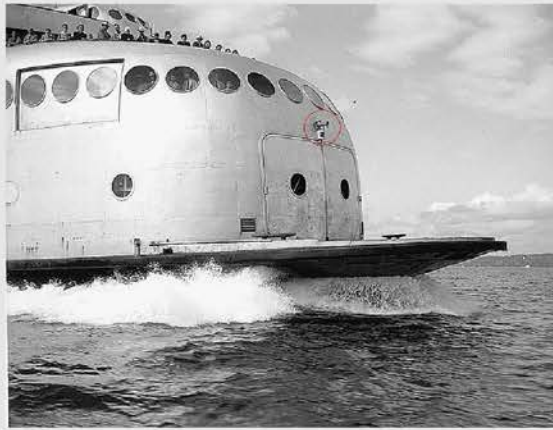





Across **PUGET SOUND** *Across* **PUGET SOUND**

Via
**BLACK
BALL LINE**

Via
**BLACK
BALL LINE**

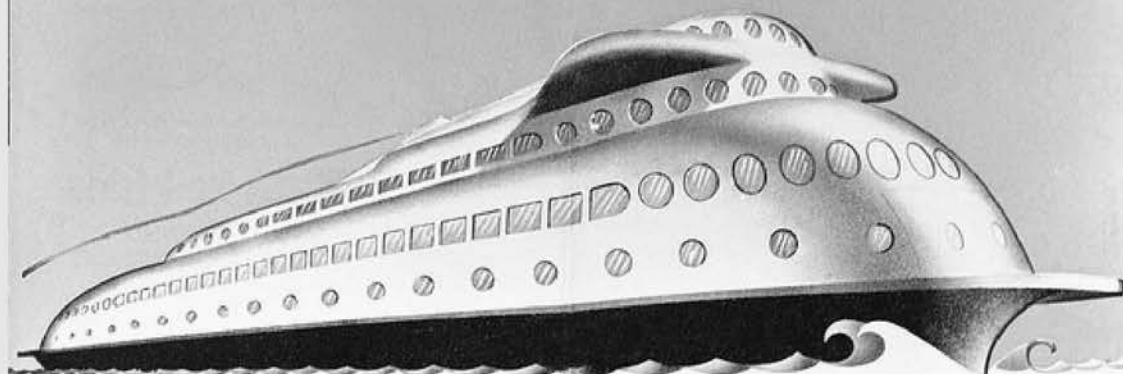

**PUGET SOUND
NAVIGATION CO.**

**PUGET SOUND
NAVIGATION CO.**



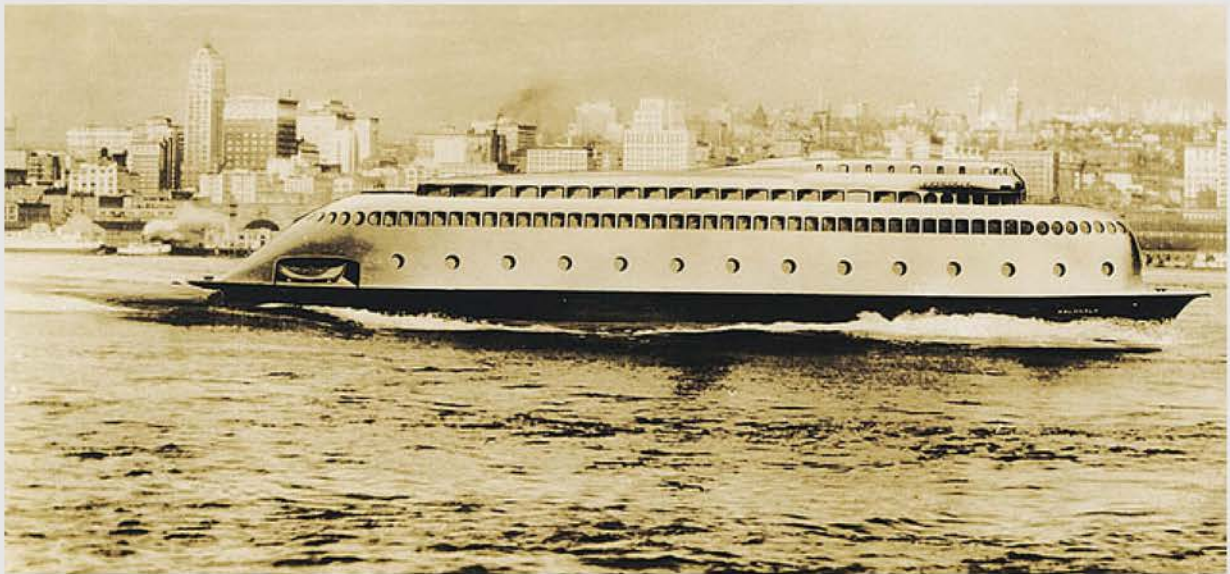

**STRECKFUS STEAMERS
PORT OF ST. LOUIS**

Flashes from the Flagship
S.S. ADMIRAL

Dancing and romancing in the Blue Salon
Cocktails in the swank Club Admiral
Cool as Maytime in the Mountains . . .
Gay "brellers" on the Lido Deck . . .
Ahooy! You're in for a circus on the Main Deck

КРУИЗНЫЕ ЛАЙНЕРЫ





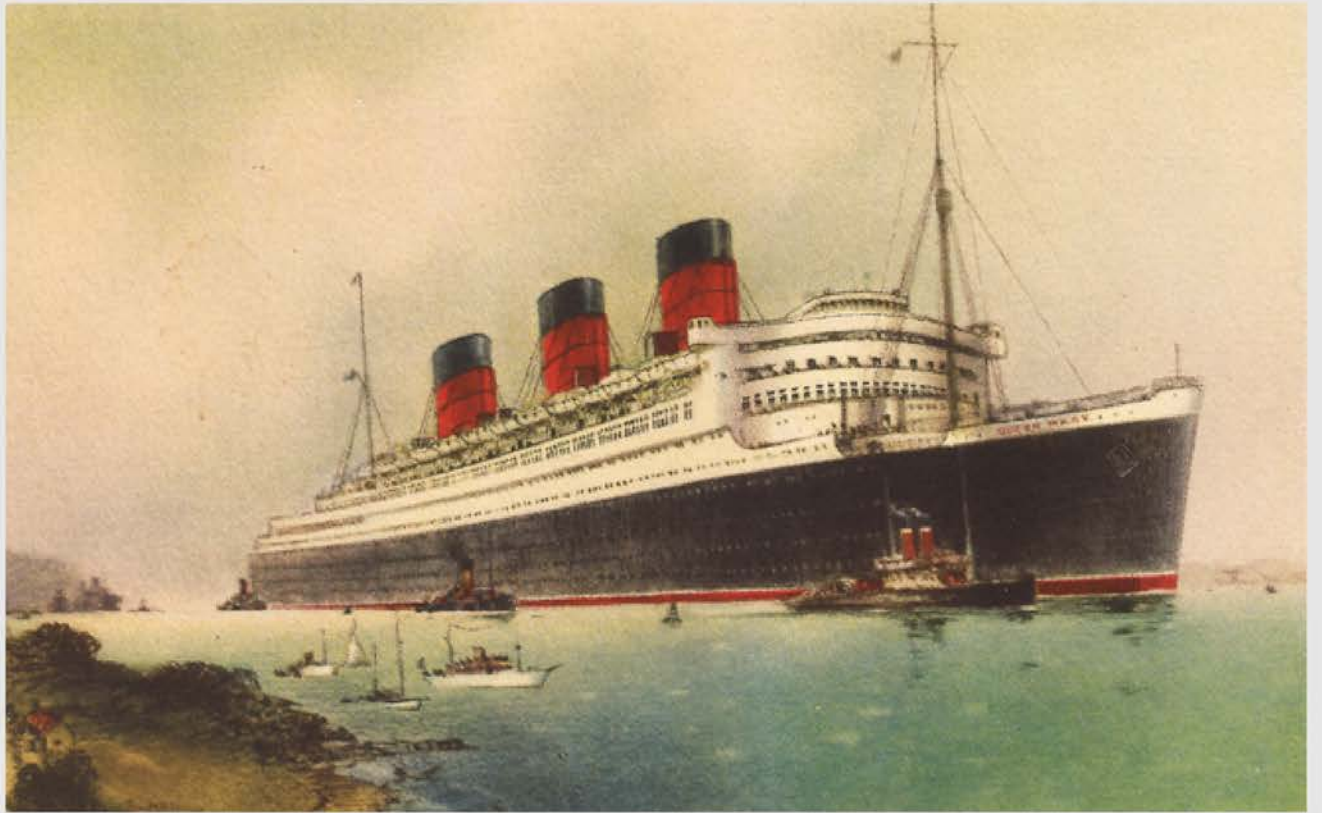

S. S. Normandie

French Line

82,799 Gross Tons











NORMANDIE

C^{IE} G^{LE} TRANSATLANTIQUE

French Line

LE HAVRE — SOUTHAMPTON — NEW YORK

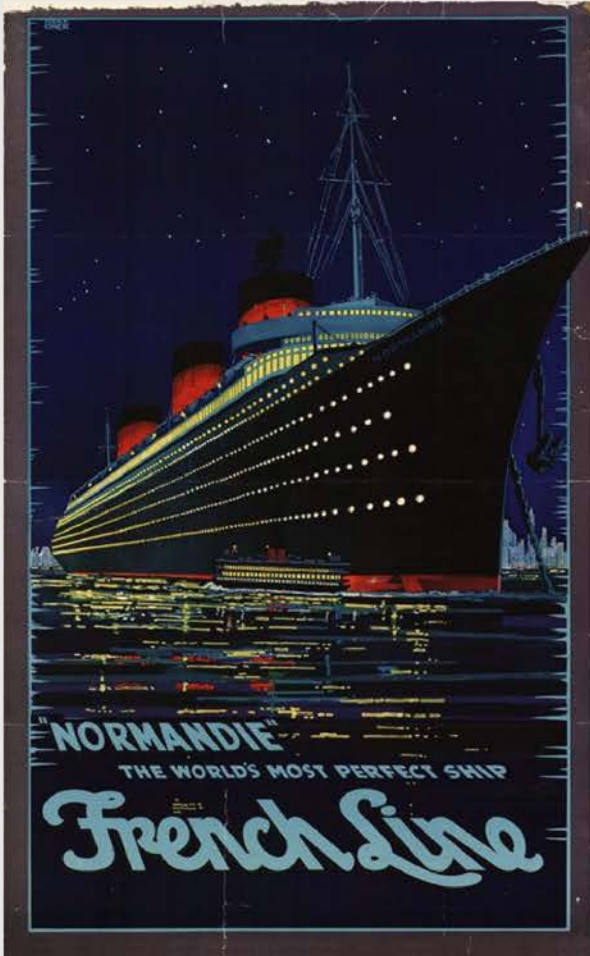

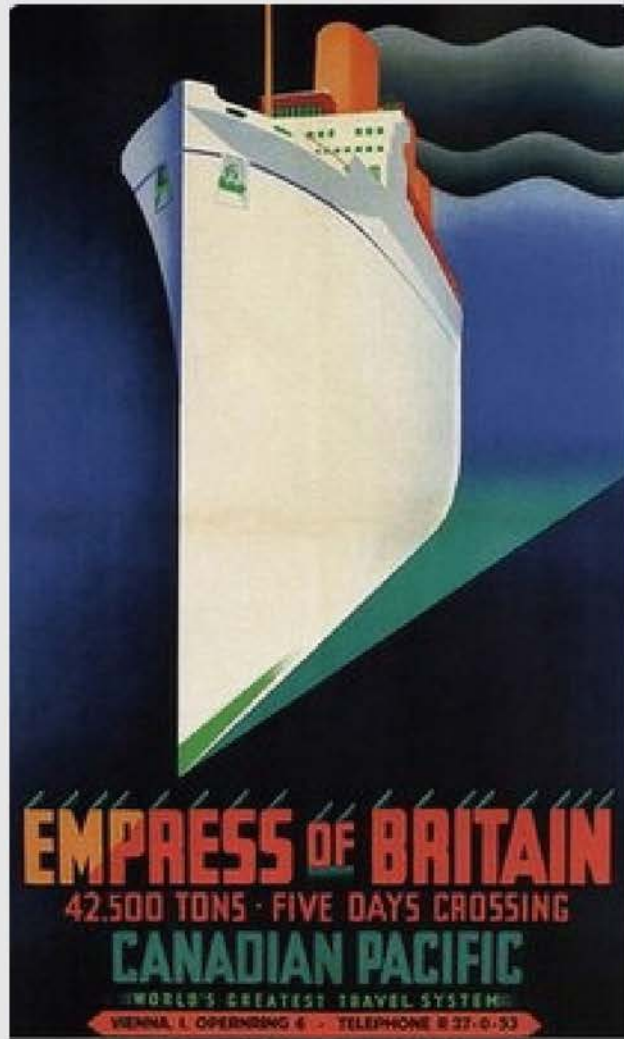

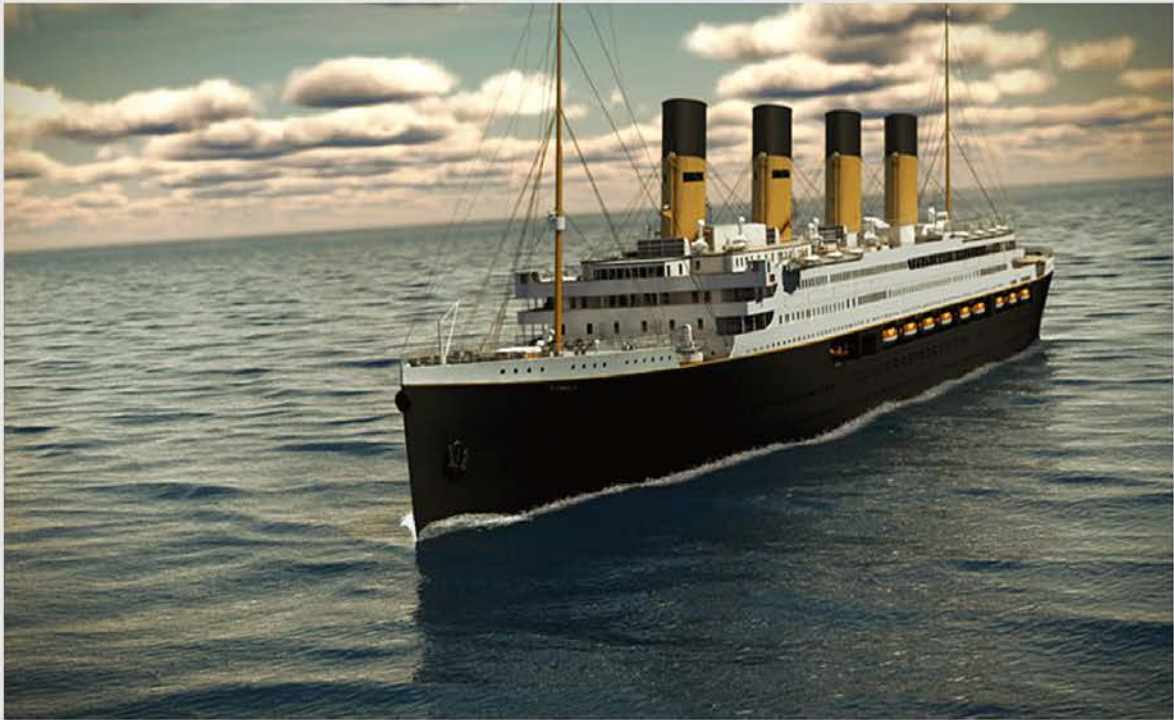

























Н.Н. АЛЕКСАНДРОВ



**САМЫЕ
ВЫРАЗИТЕЛЬНЫЕ
АВТОМОБИЛИ
1930-х**

























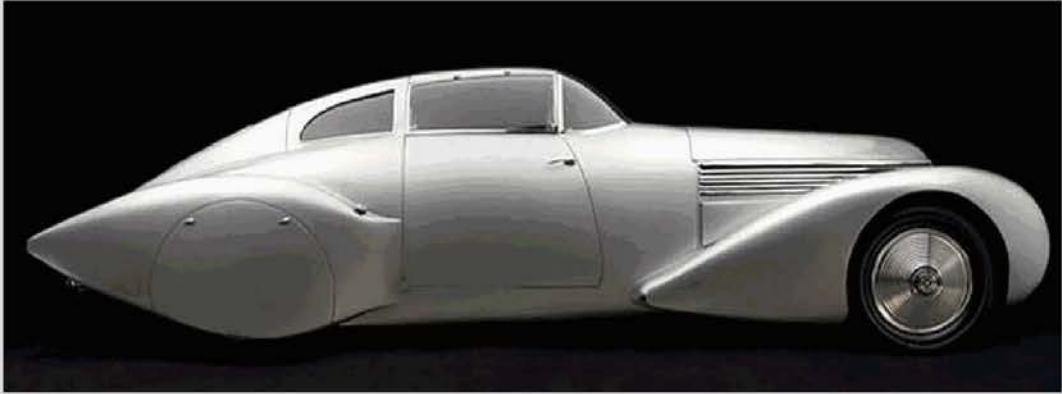









Н.Н. Александров

ОБТЕКАЕМЫЙ СТИЛЬ



1930-е

**В ПОИСКАХ СТИЛЯ
НОРМАН БЕЛ ГЕДДЕС**



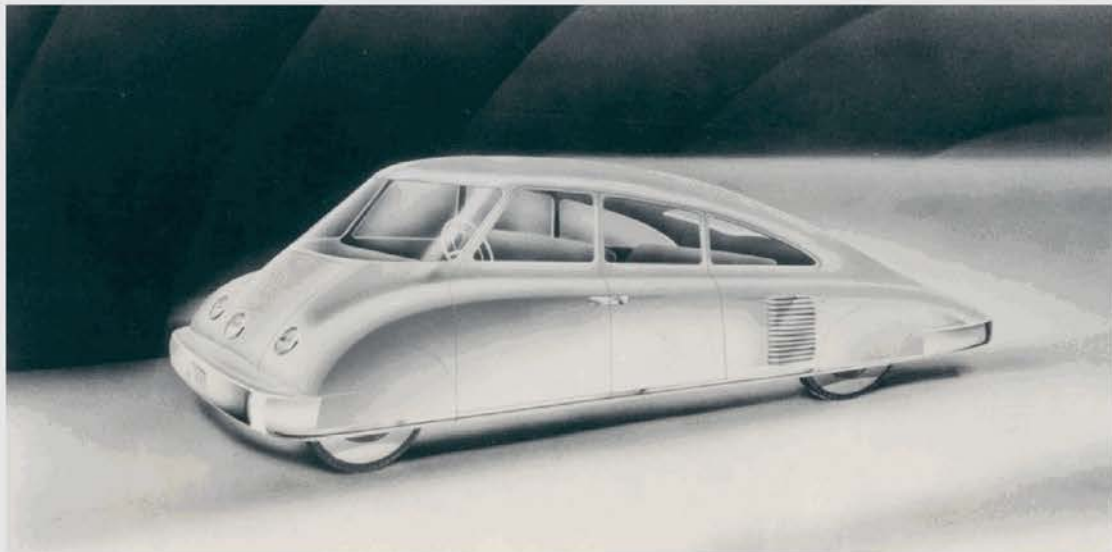
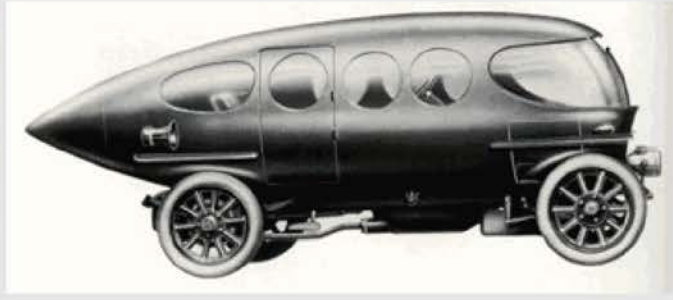

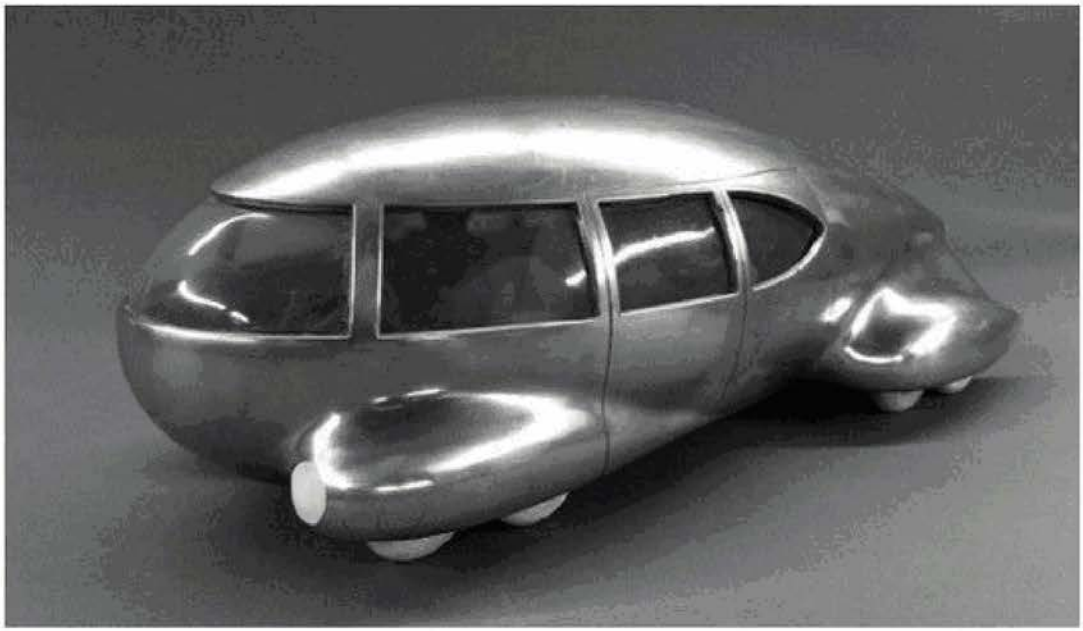

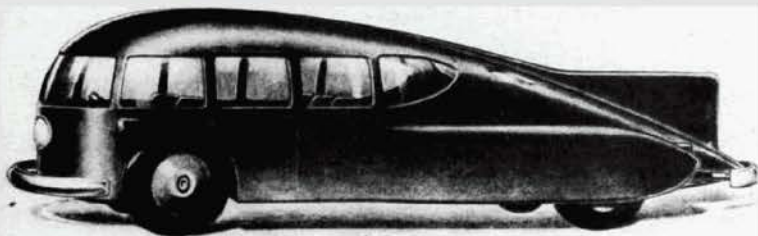
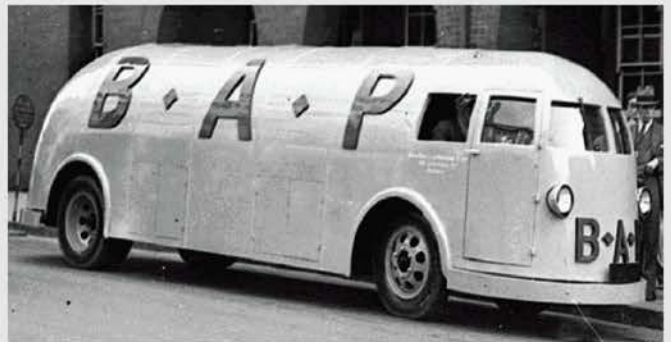
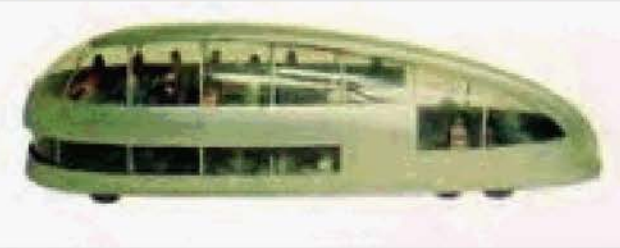
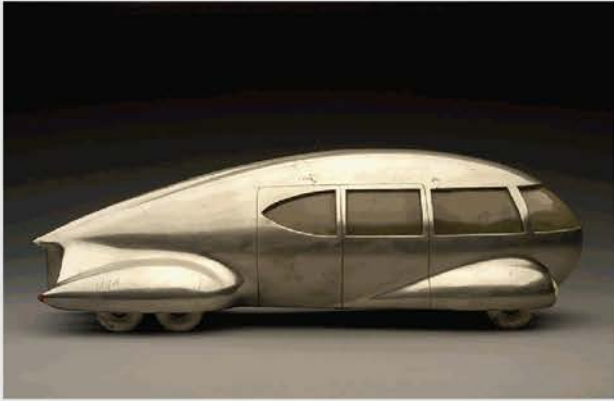

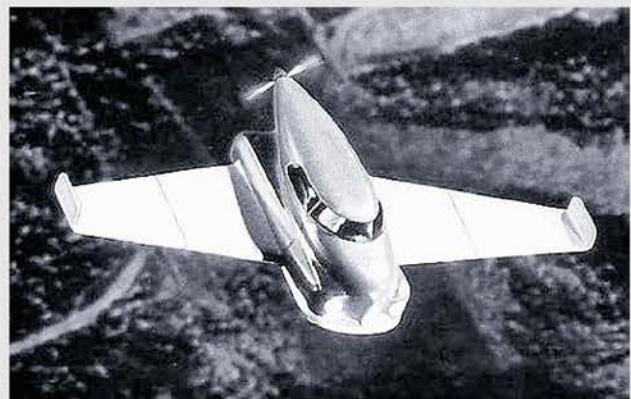
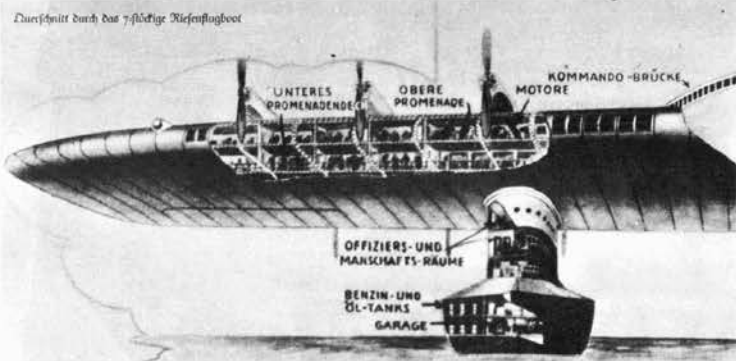
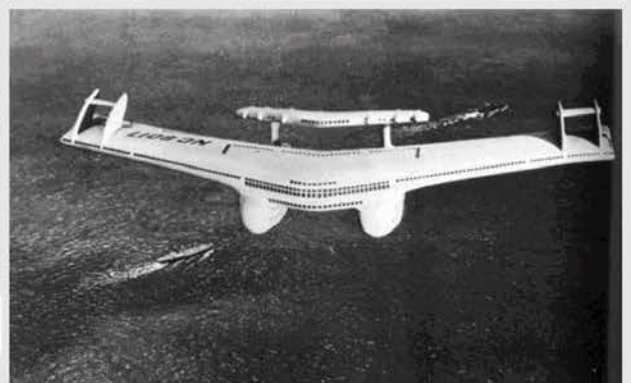
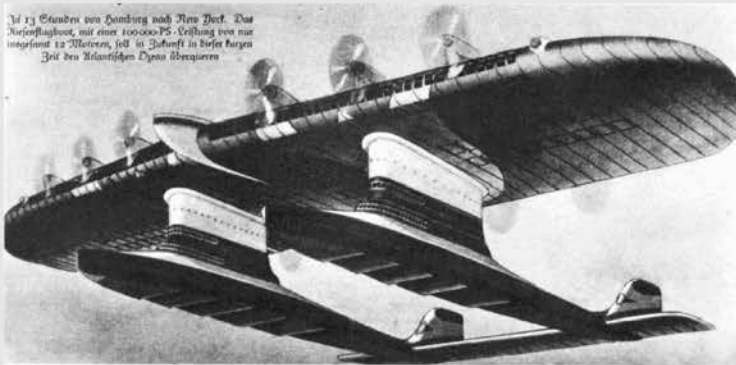
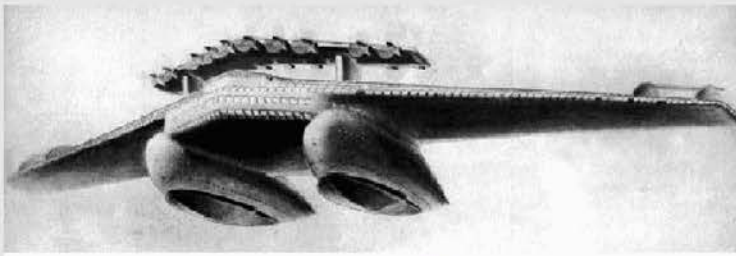

14 1/2 Stunden von Hamburg nach New York. Das
Luftschiffboot, mit einer 100000-PS-Verstellung von nur
insgesamt 12 Motoren, soll in Zukunft in dieser kurzen
Zeit den Atlantischen Ozean überqueren

Durchschnitt durch das 7-schichtige Luftschiffboot

UNTERES PROMENADEDECK
OBERE PROMENADE
KOMMANDO-BRÜCKE
MOTOREN
OFFIZIERS-UND
MANSCHAFTS-RÄUME
BENZIN-UND
ÖL-TANKS
GARAGE



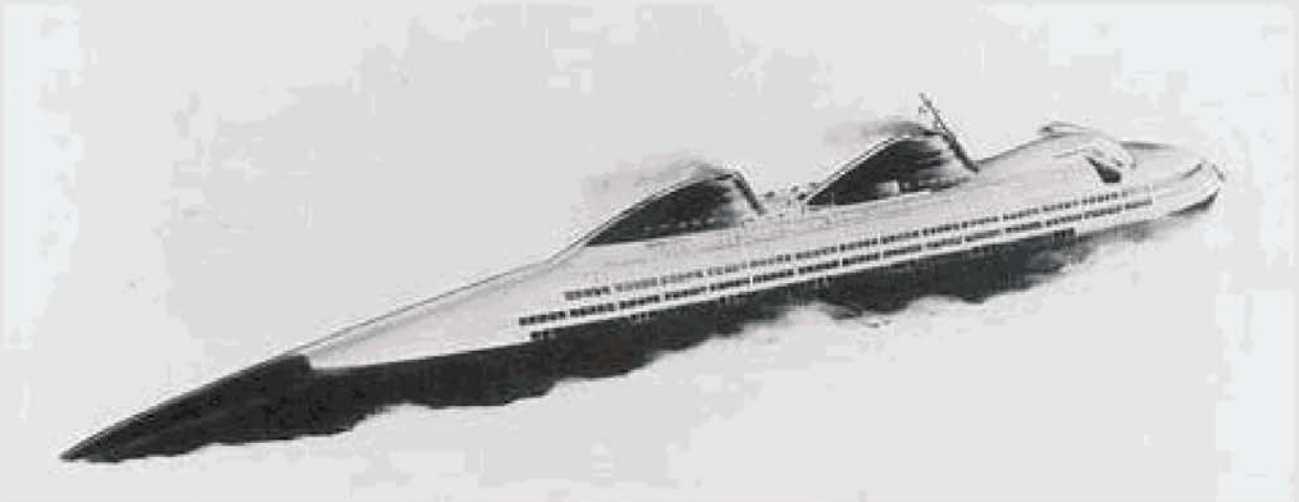
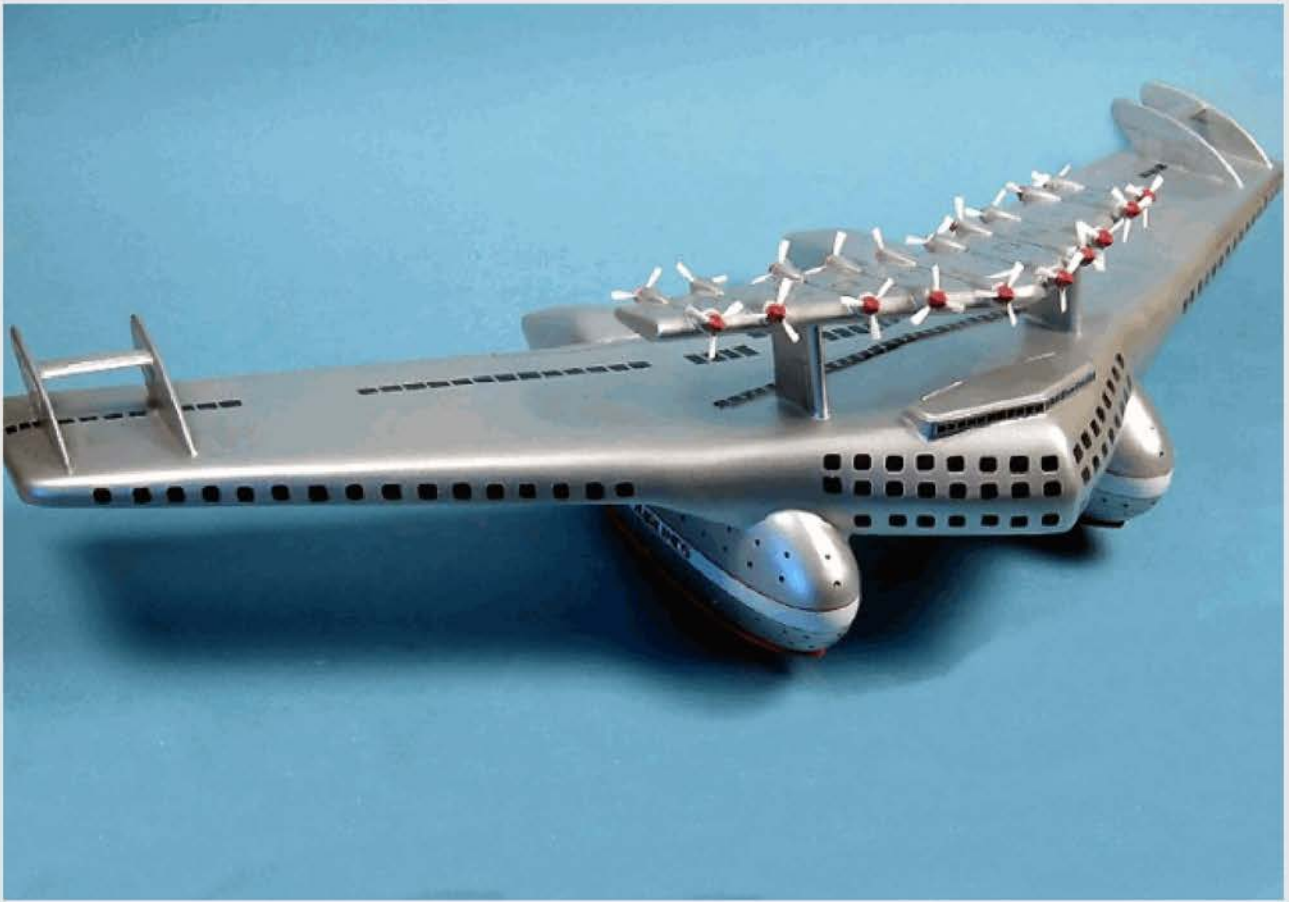

**АВТОТЕХНИКА
ОБТЕКАЕМОГО СТИЛЯ
1930-х**



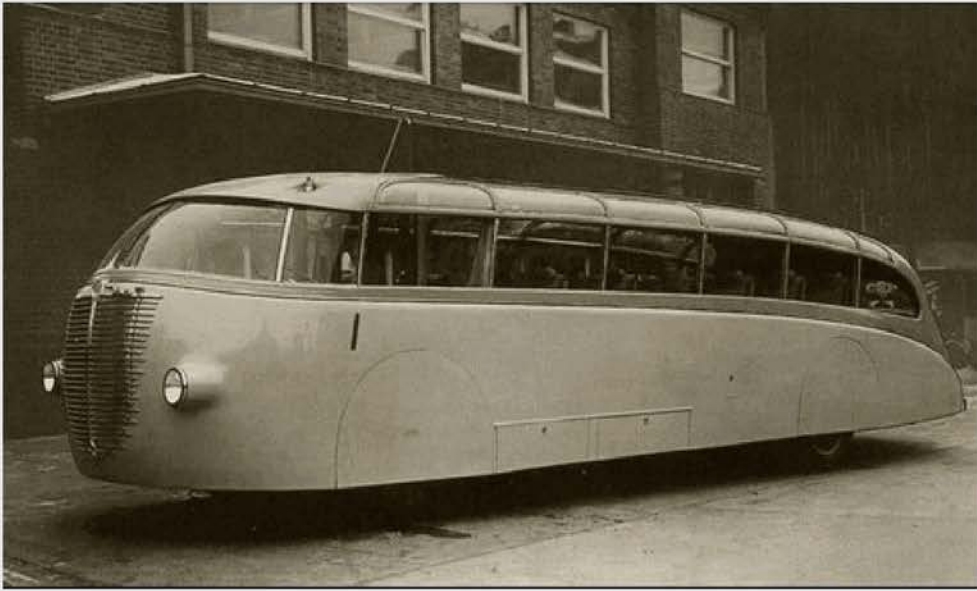





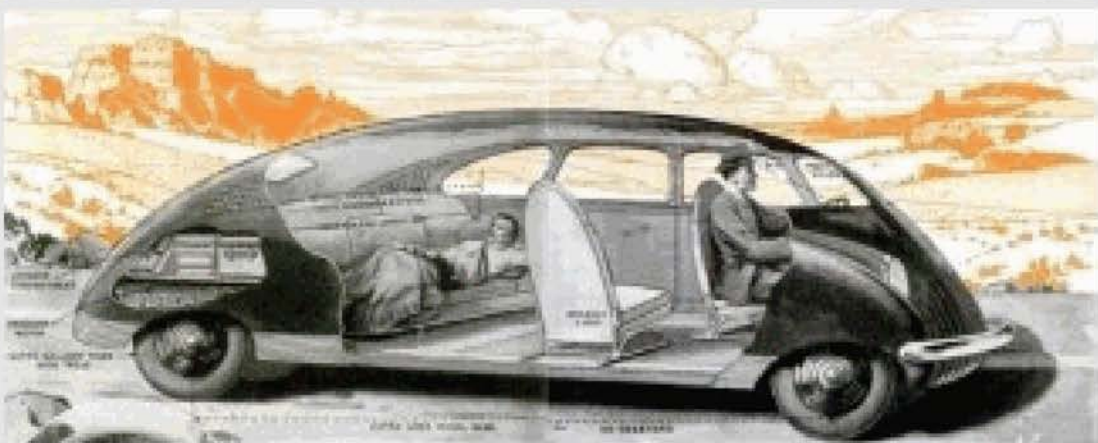









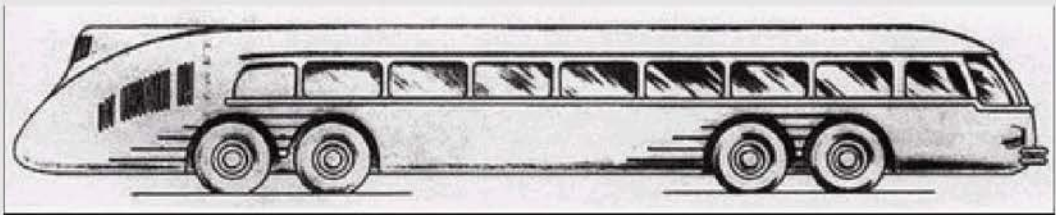
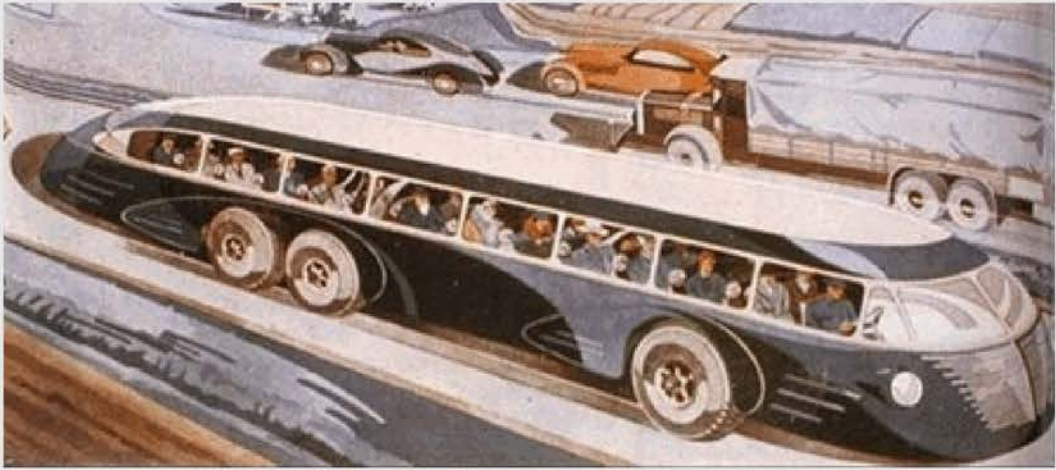

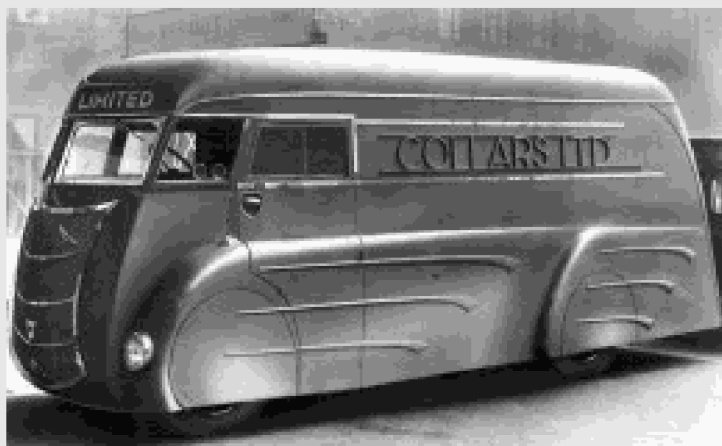
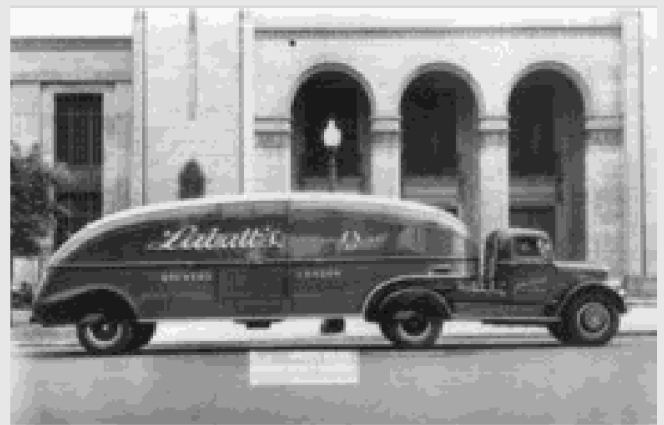

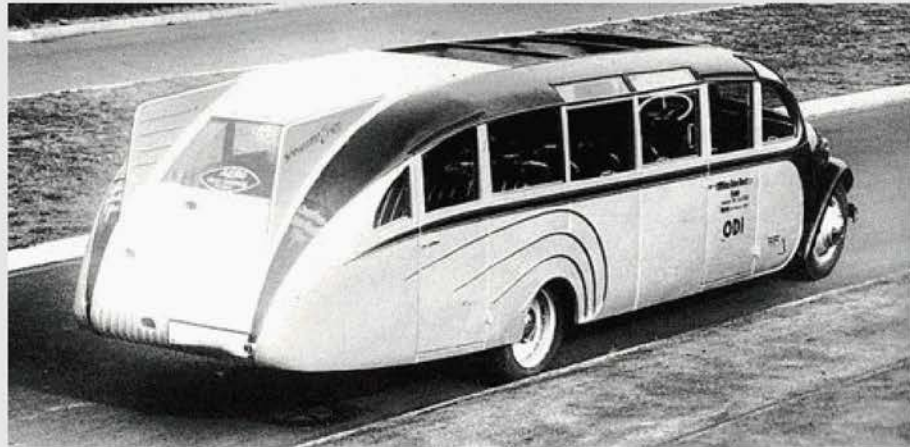



ПУТЬ В 1950-е

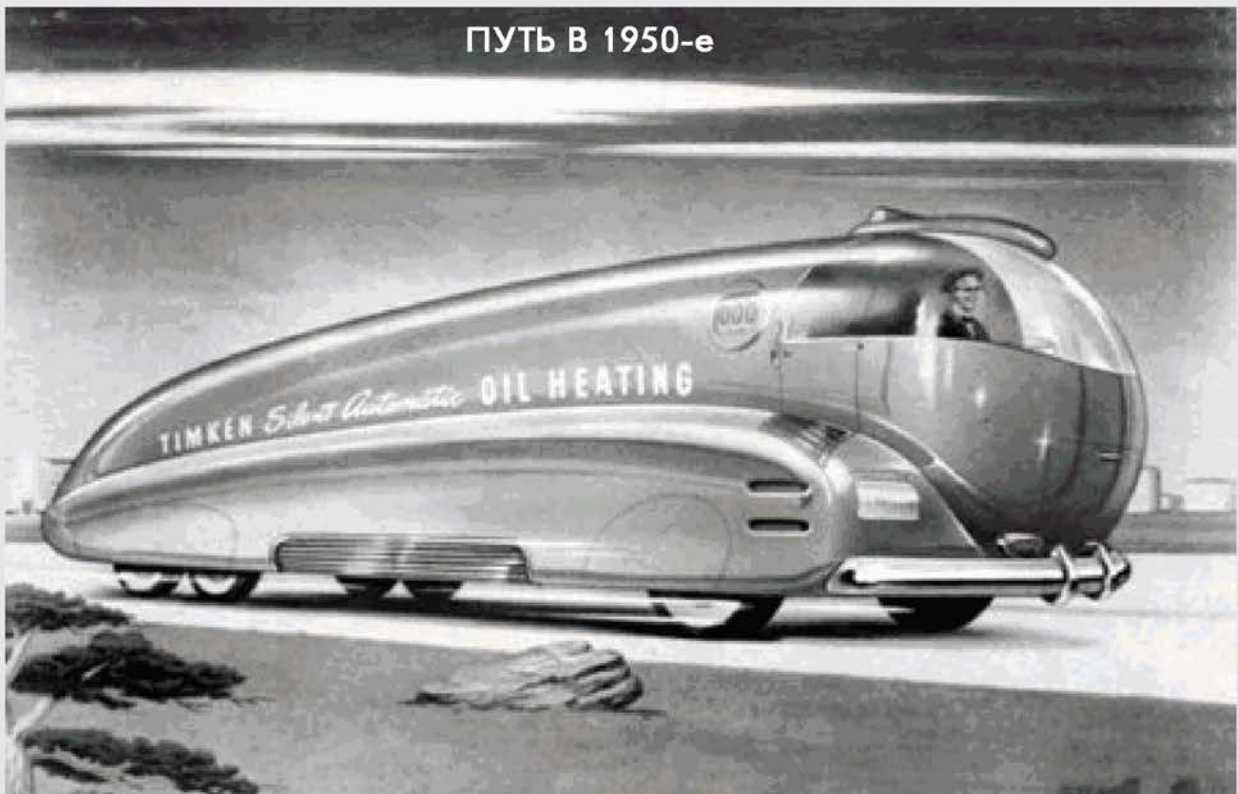

ART DECO

ФАНТАСТИКА



THRILLING TALES OF THE DOWNRIGHT UNUSUAL

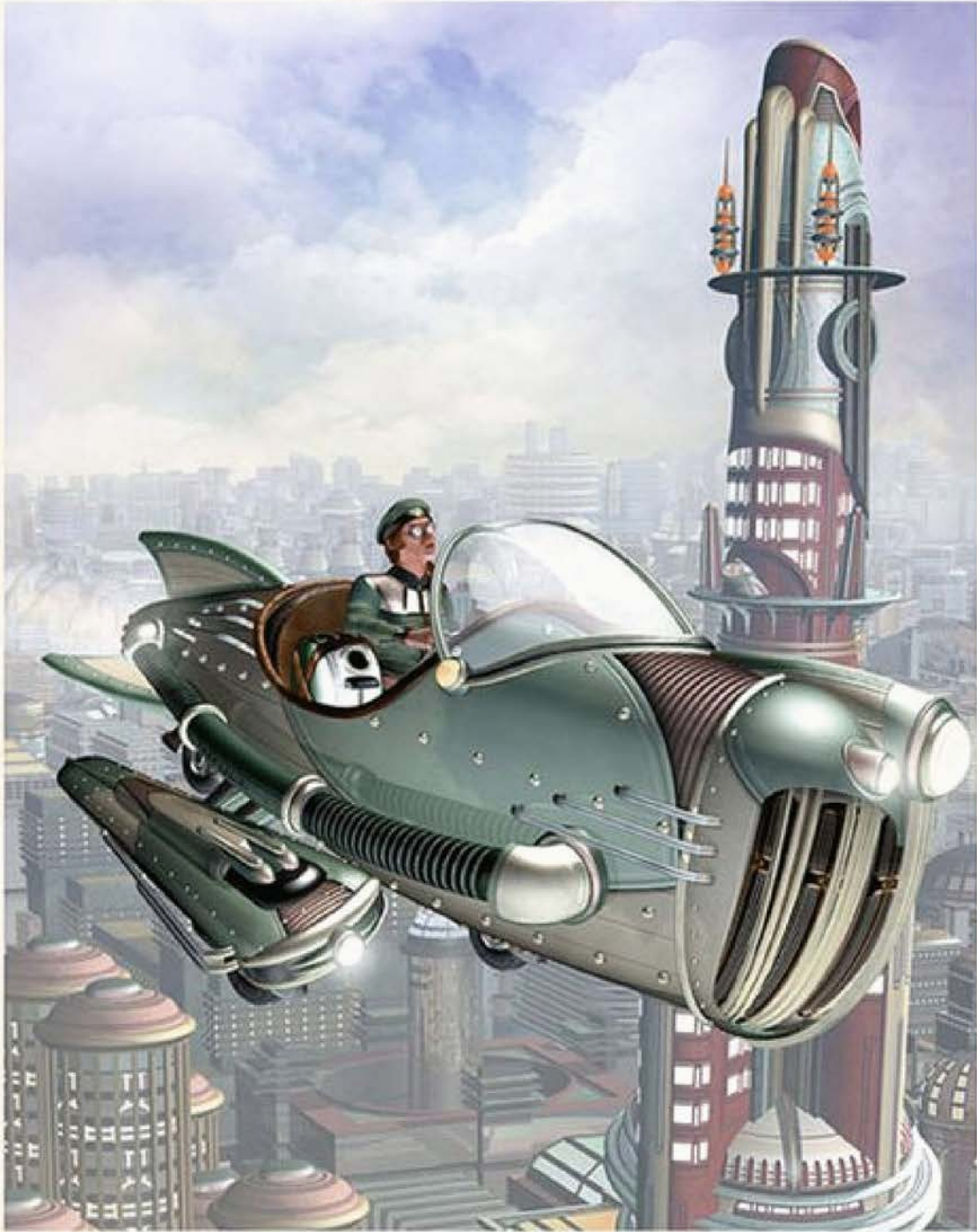

G.WEN IN THE HIDE MOBILE DOCKET FROM FOADDEN IN THE LOWED OF THE ROADN THIEVES

BRADLEY W. SCHENCK - 2010



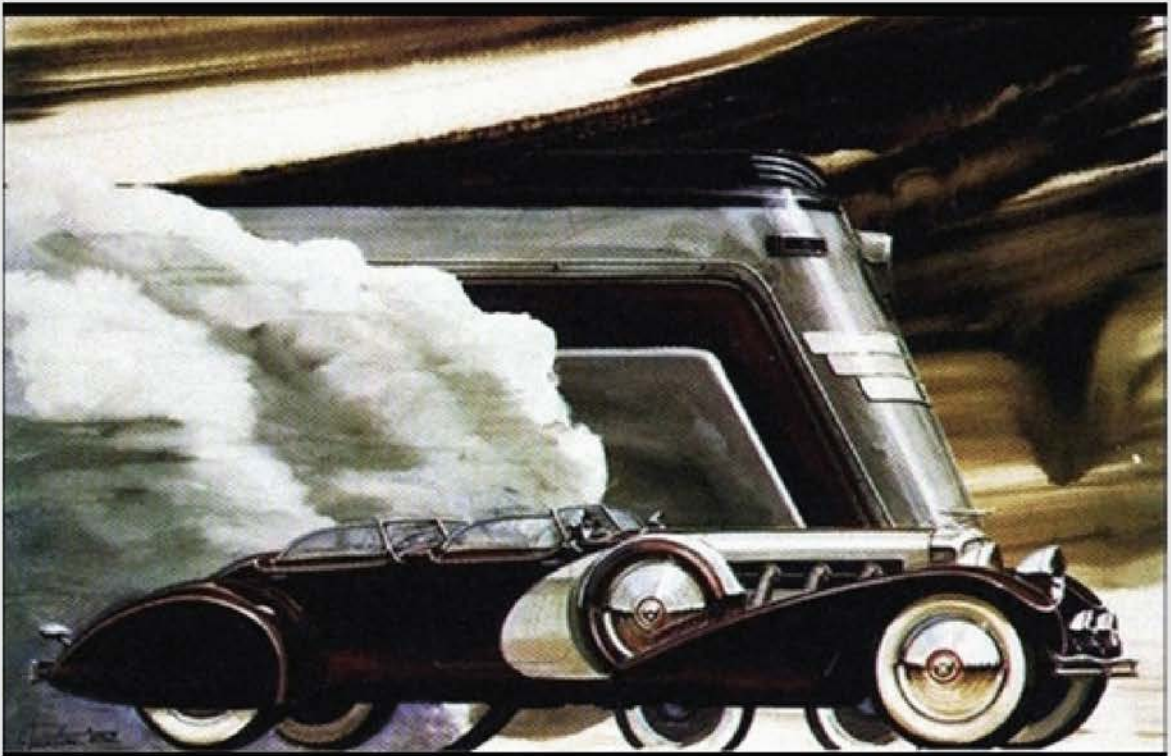

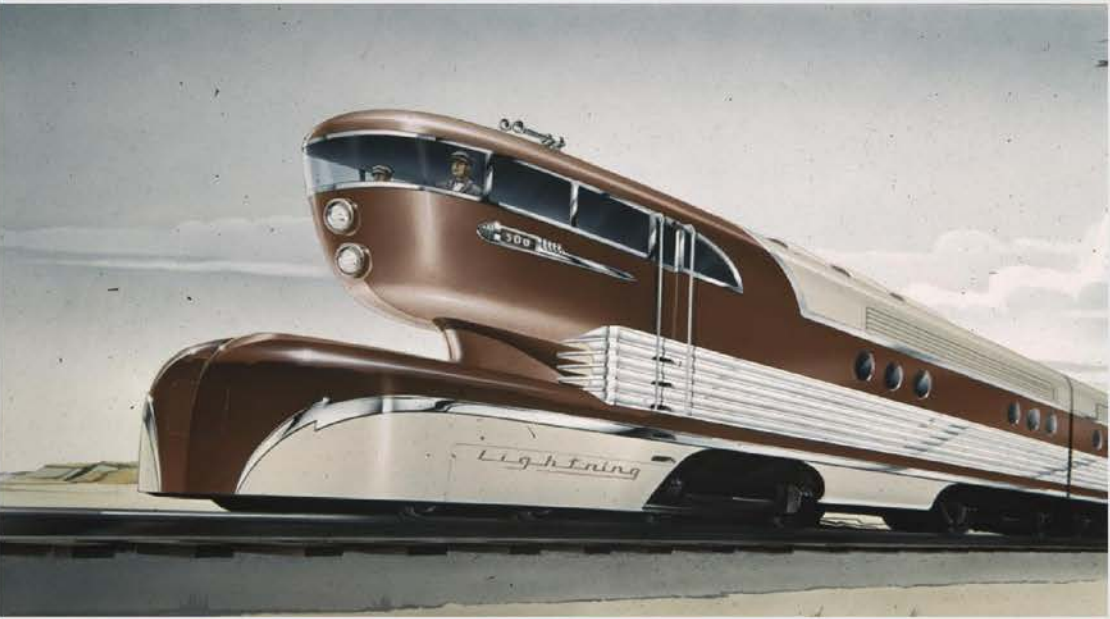

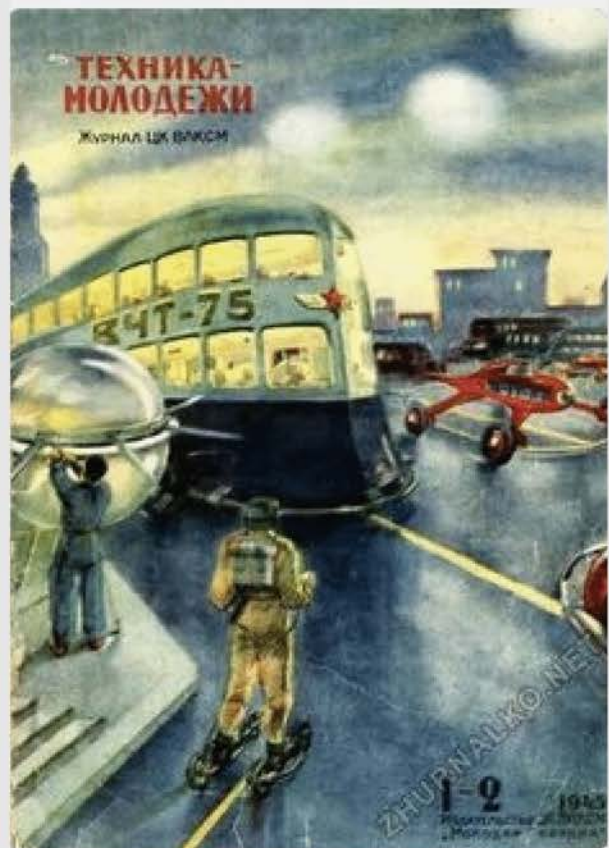

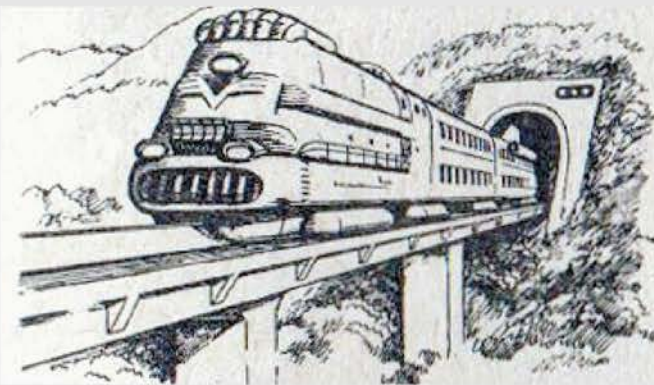
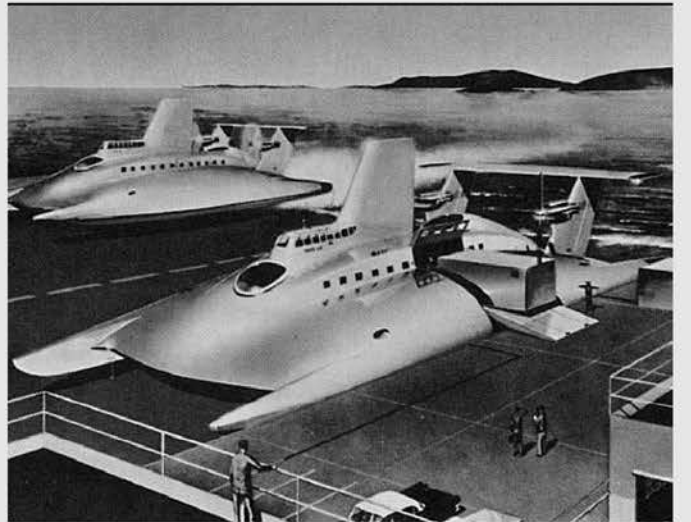
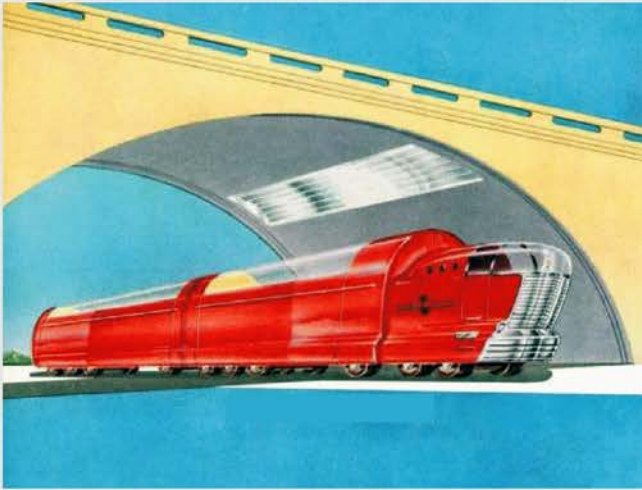

Broader Wings

TO SPAN THE NATION... And the graceful sweep of their arrival marks an epochal advance in air travel. TWA's new Boeing Stratoliners are here! And with them come spaciousness, smoothness, luxury and speeds never before known along any commercial airway in the nation. By presenting Stratoliners today, TWA again, as in the past, is first to put the proved into practice, once more demonstrating that Progress goes hand in hand with Precision on the airline run by flyers.

TRANSCONTINENTAL & WESTERN AIR, Inc.



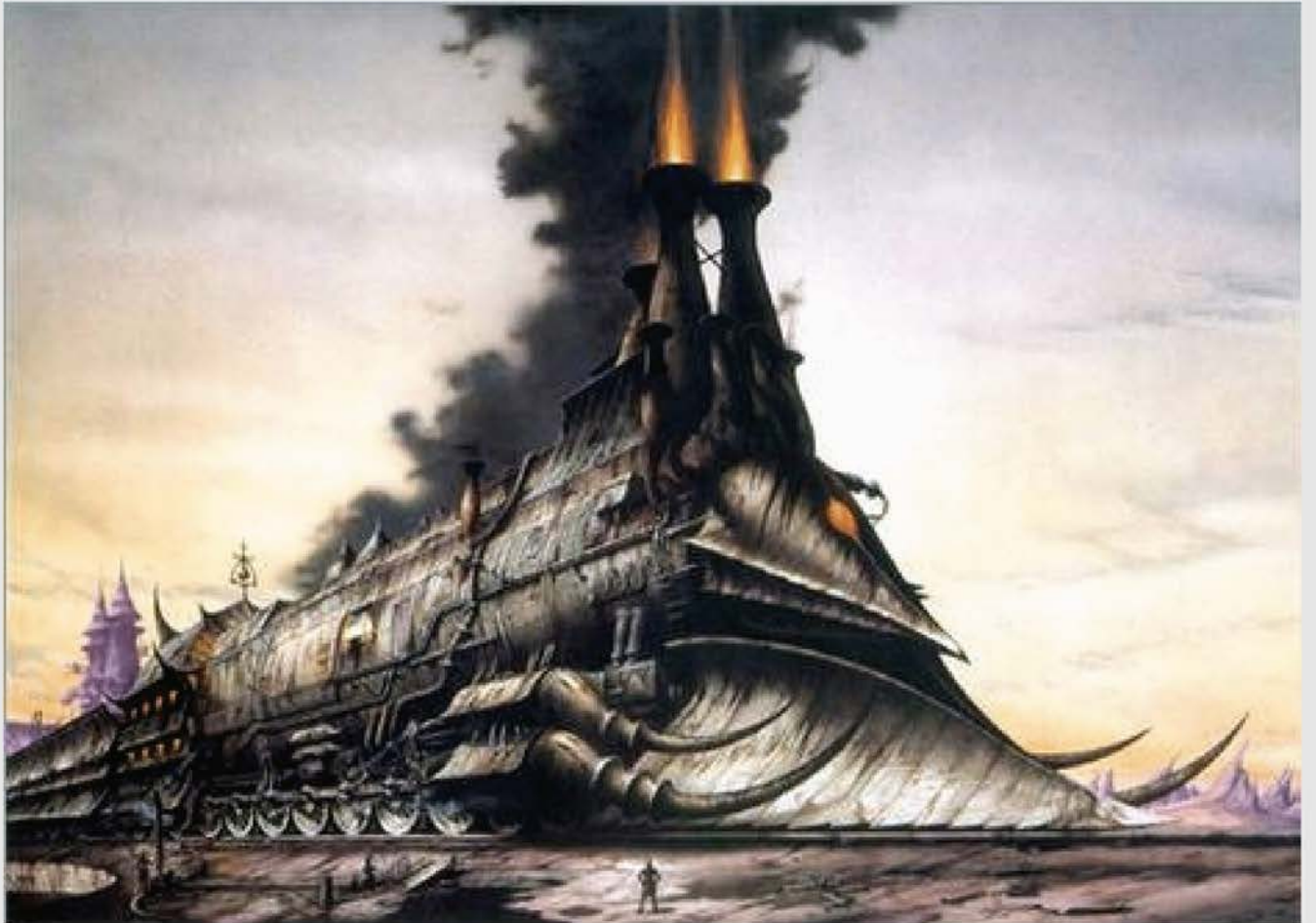
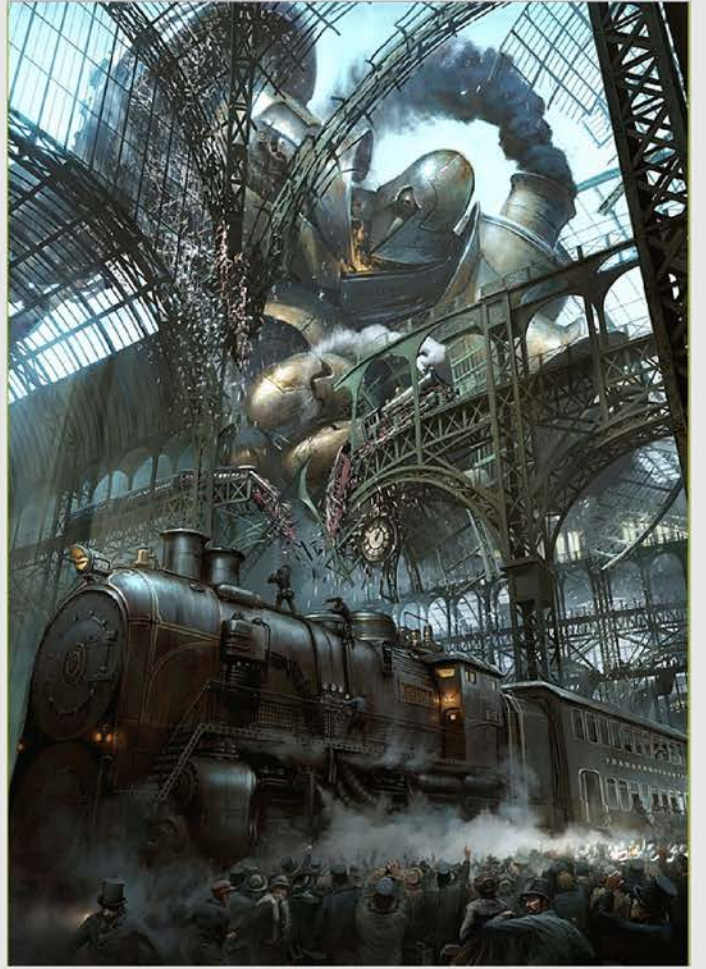

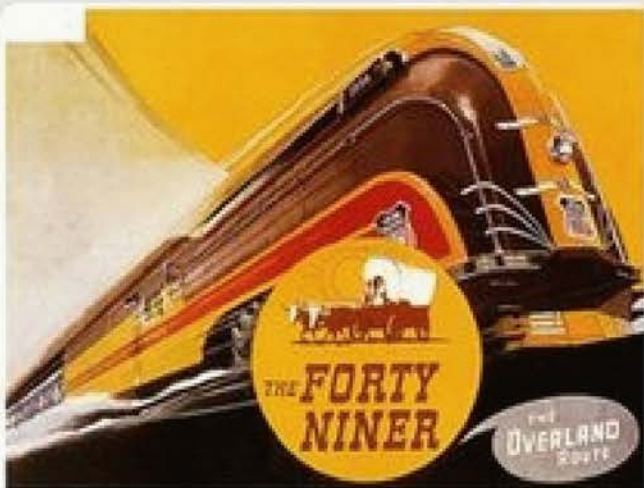
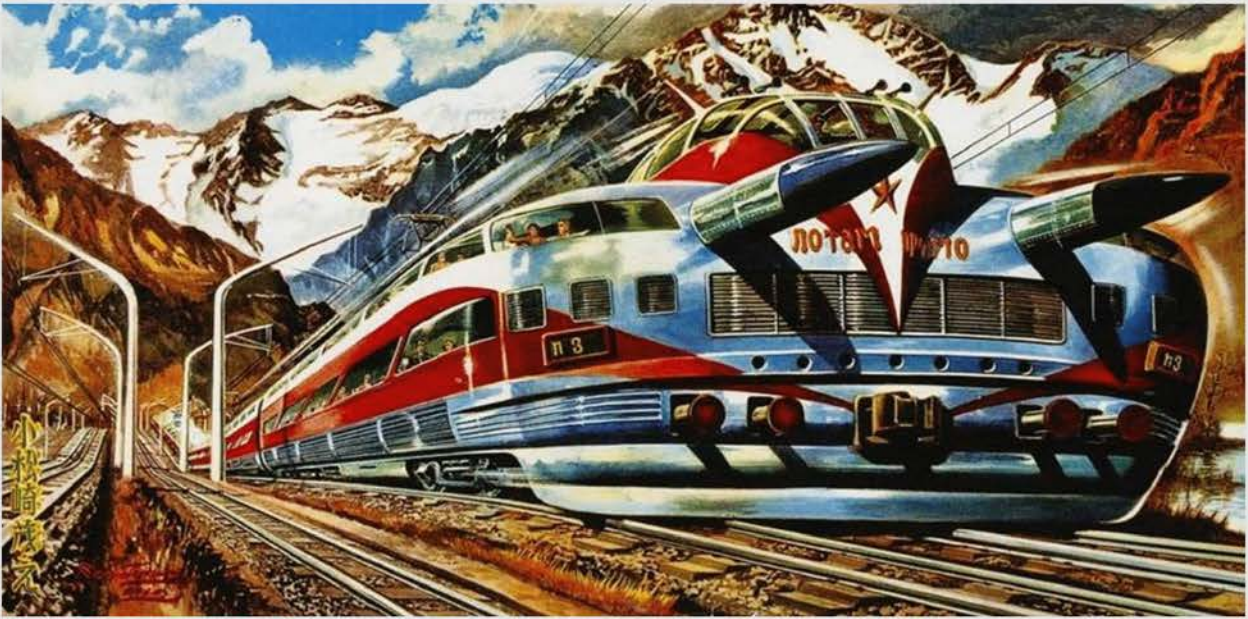



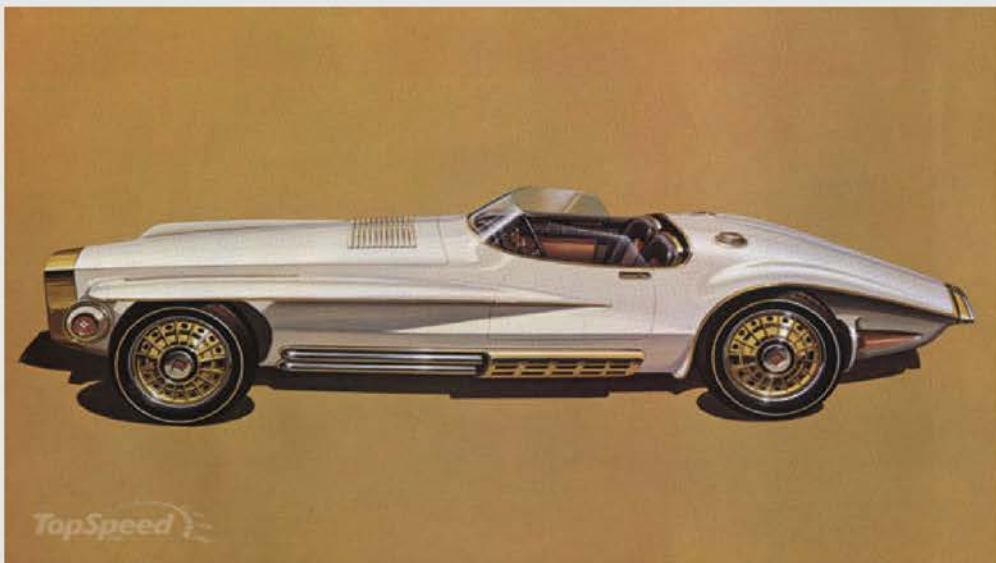

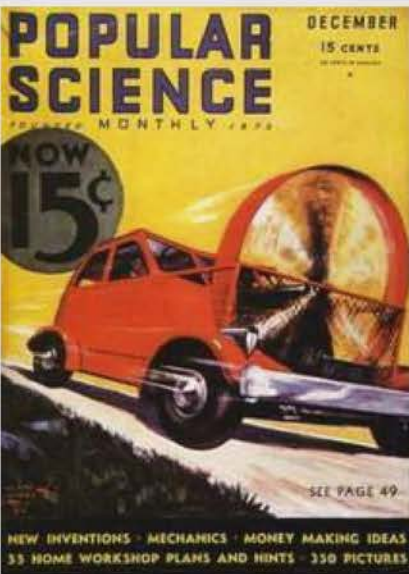
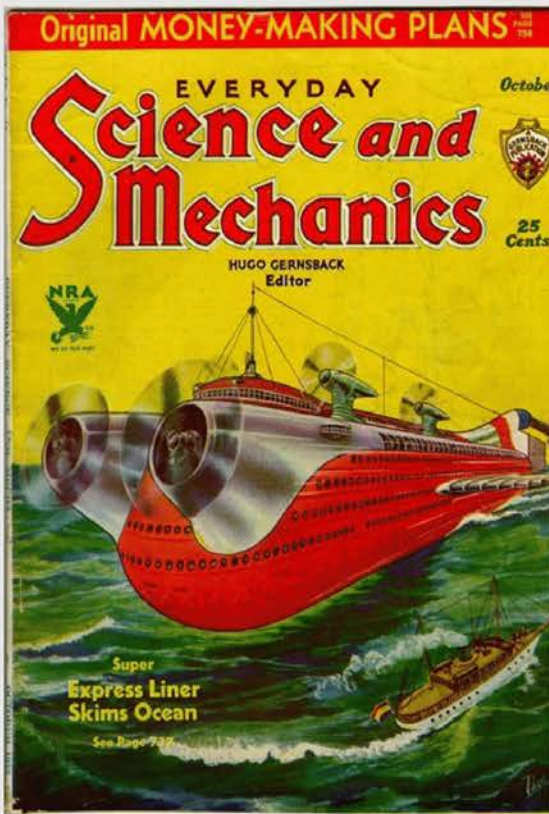

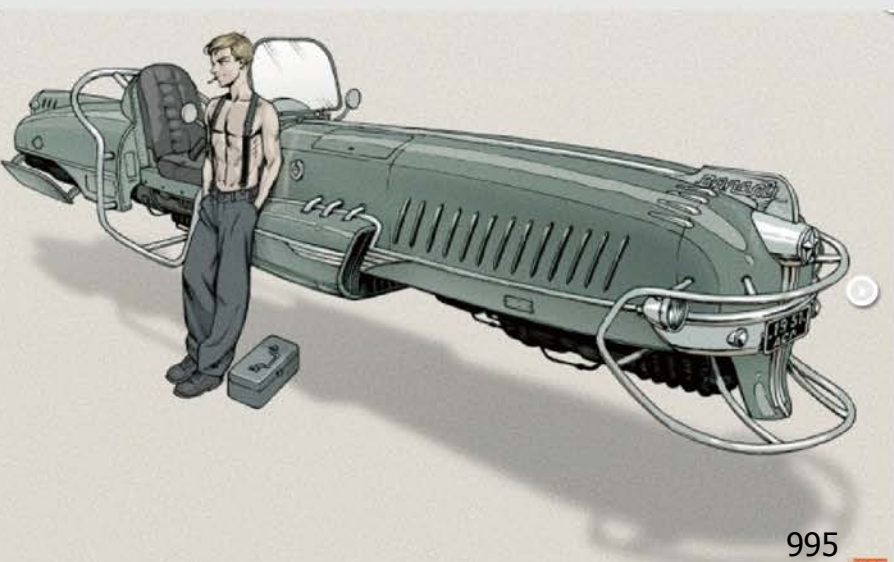
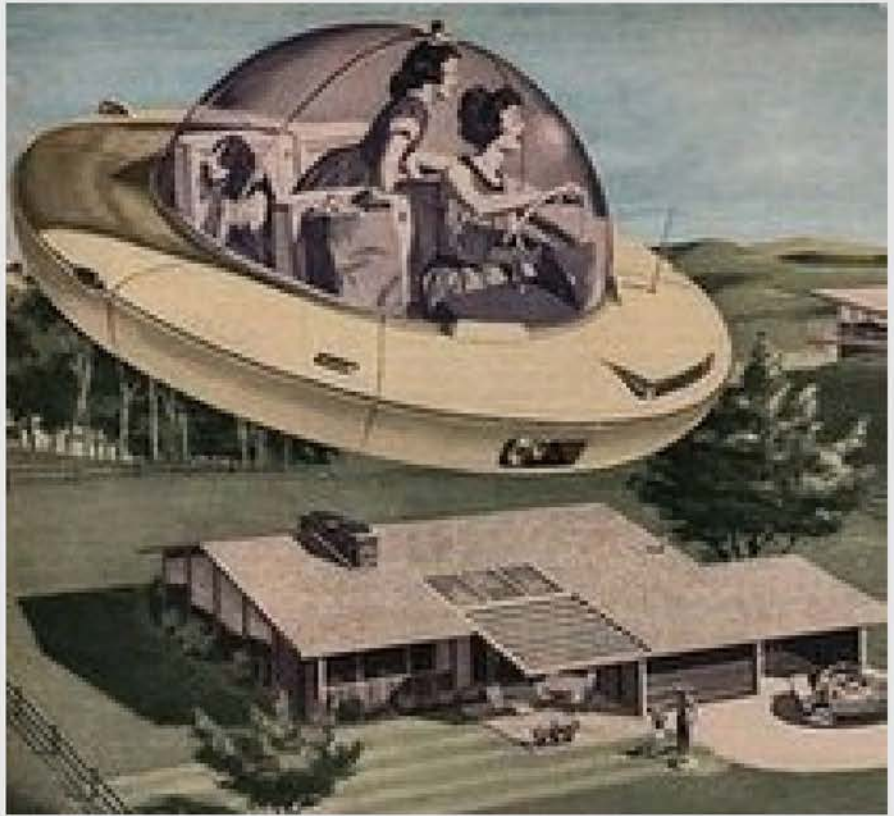







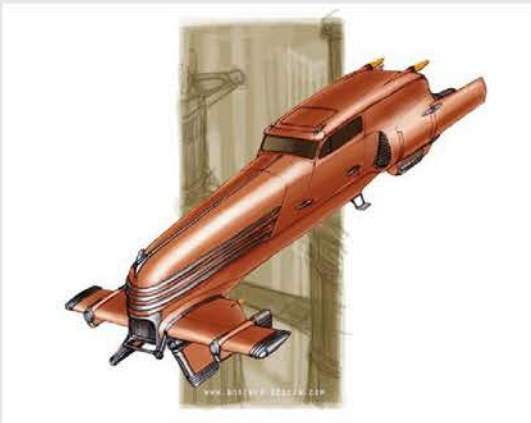





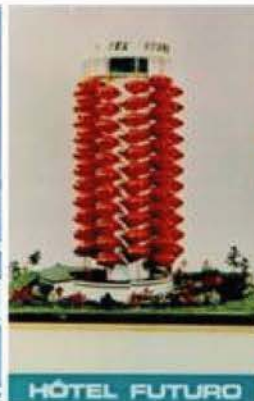

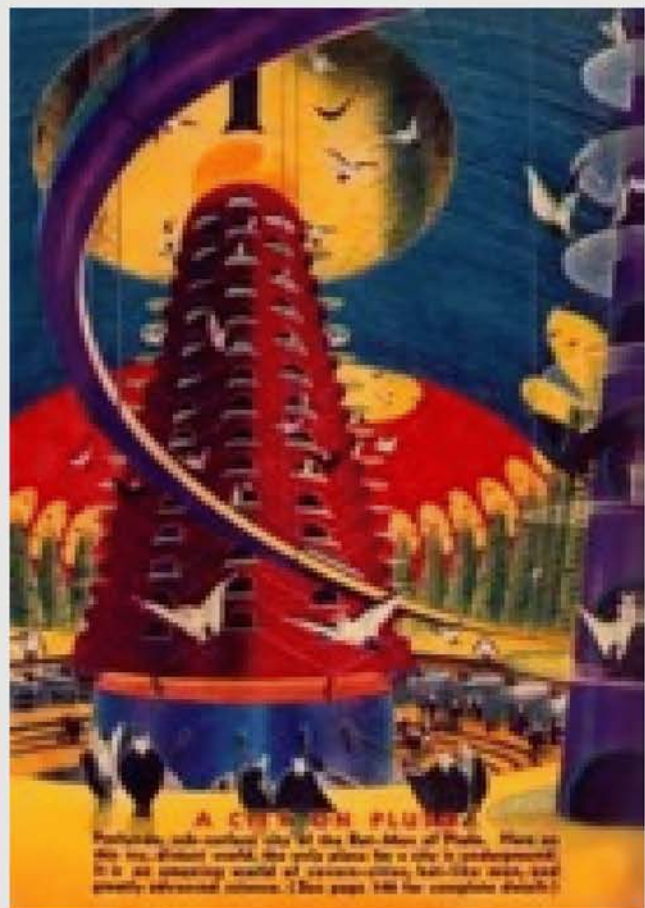
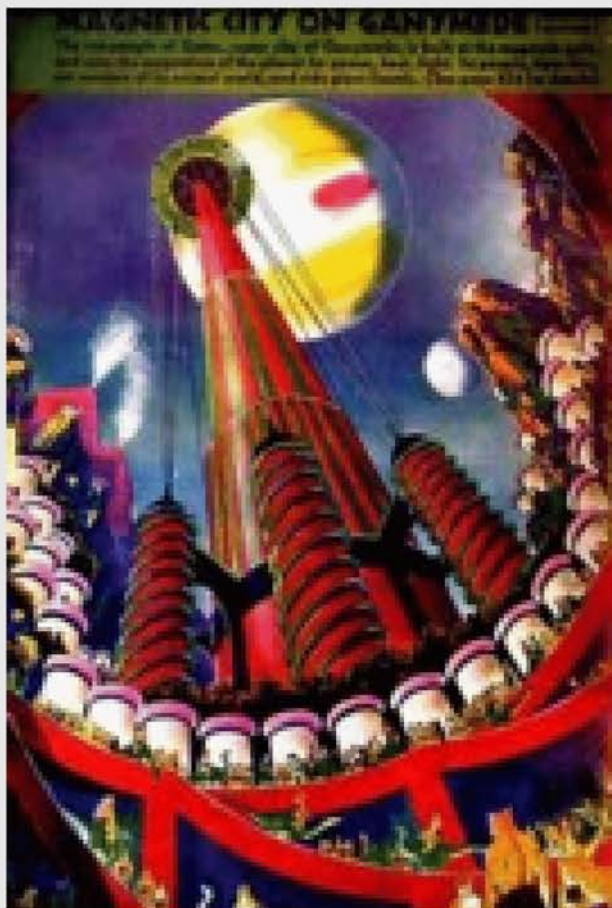

Техника - молодёжи
1949-02, страница 1

№3

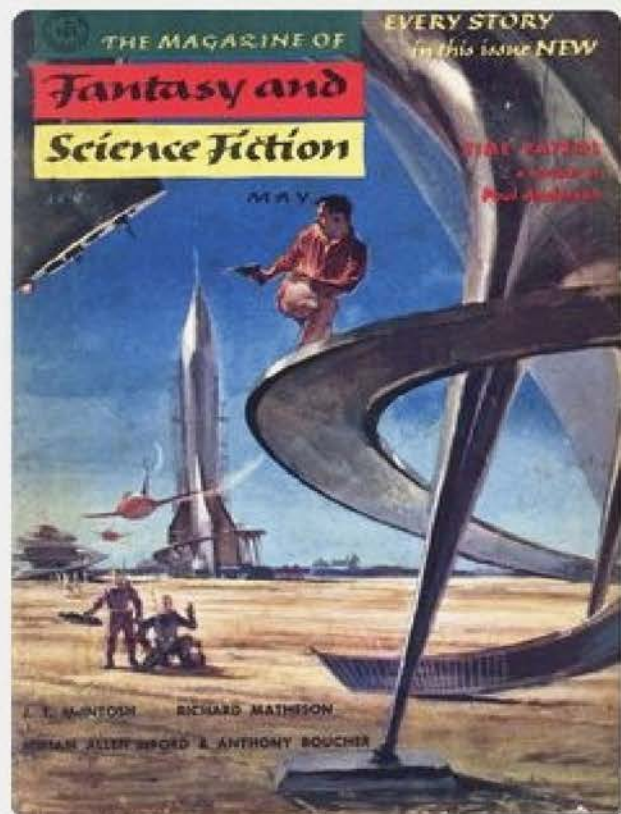

The Magazine of Fantasy
and Science Fiction (May
1955)

№115





600V.DEVIANTART.COM



600V.DEVIANTART.COM

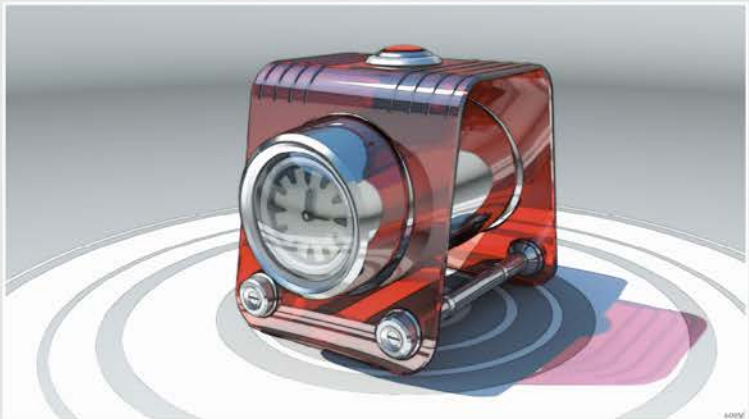

600V



600V.DEVIANTART.COM



600V





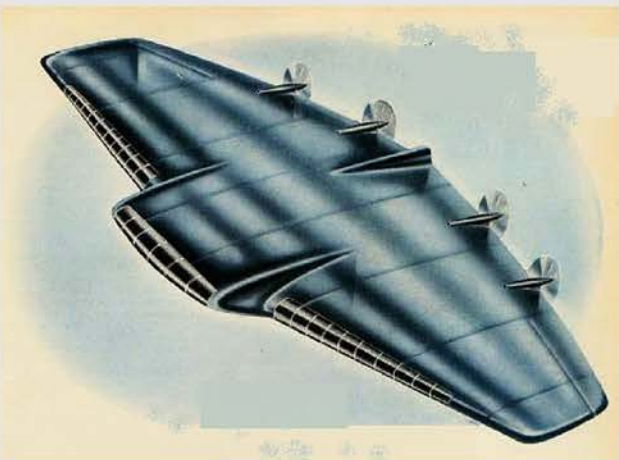

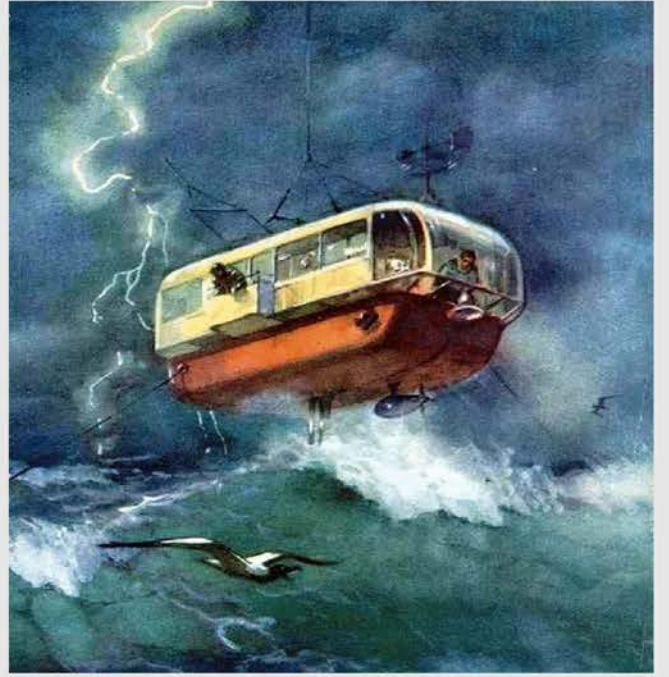
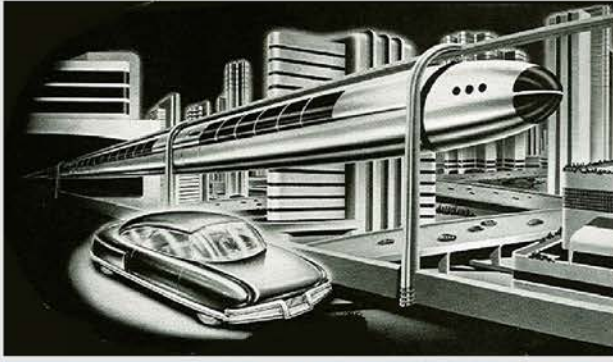

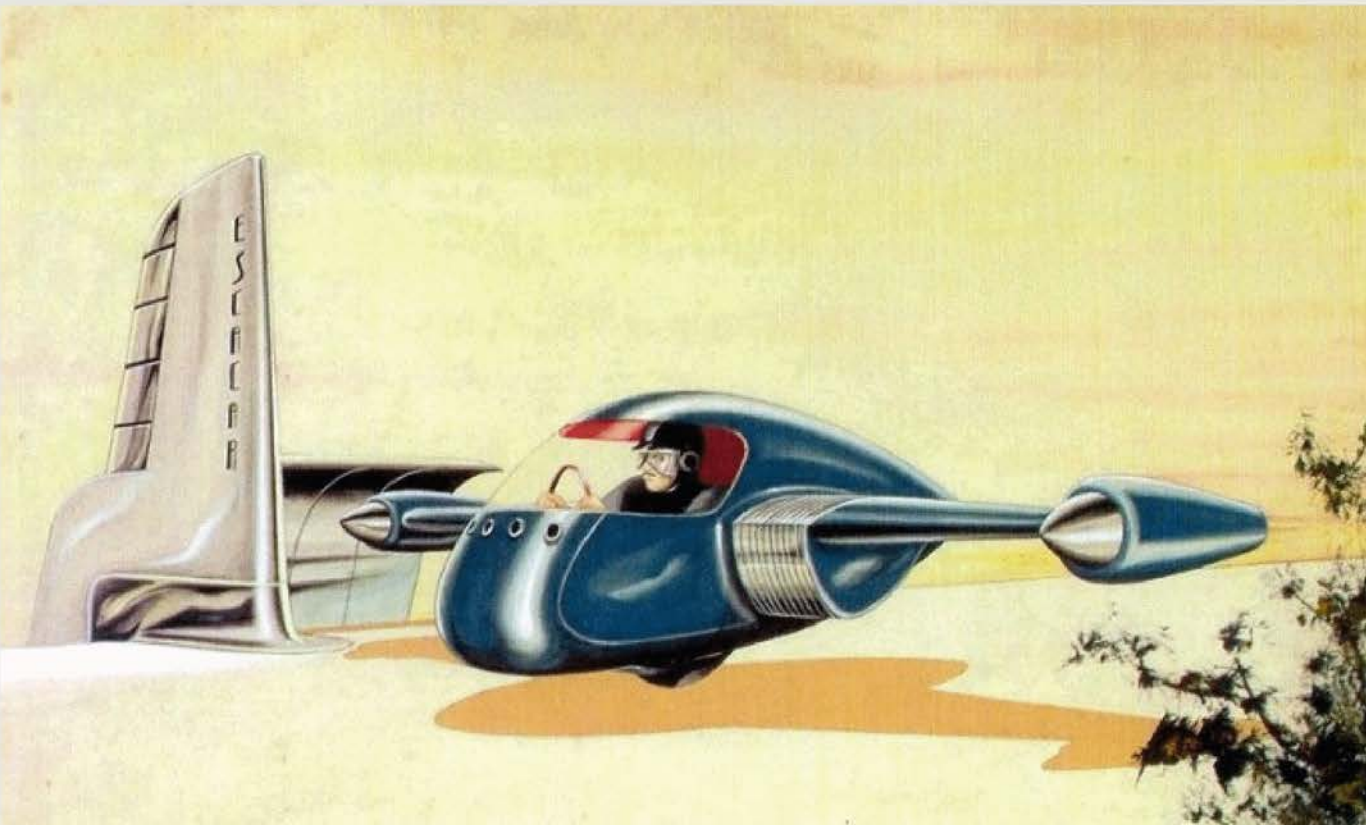
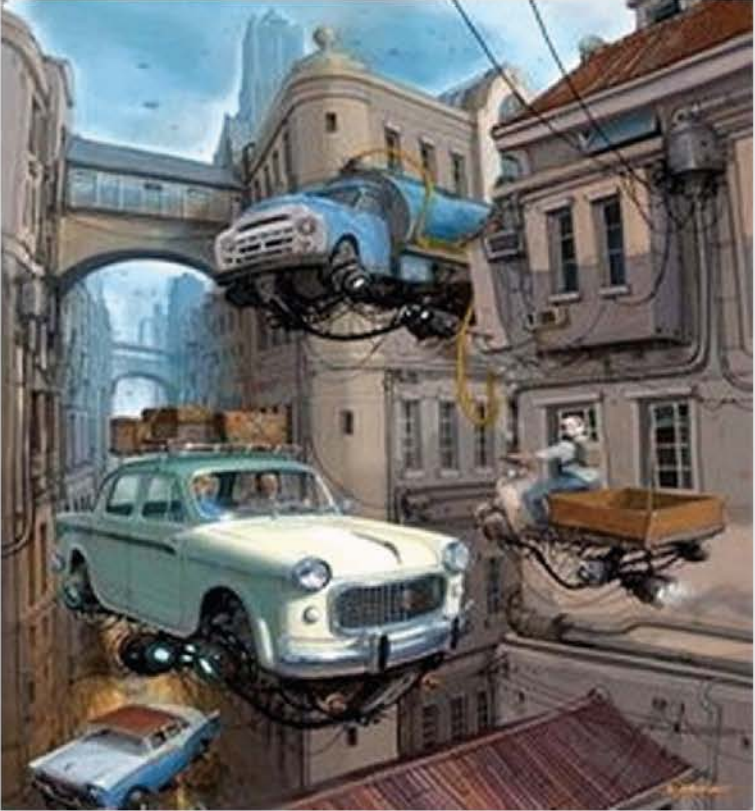

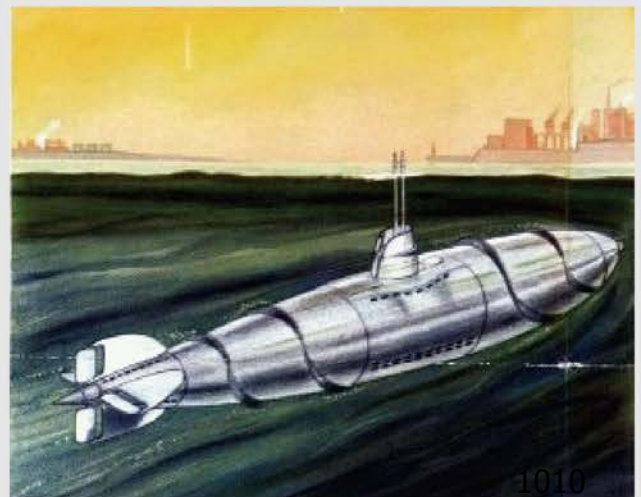
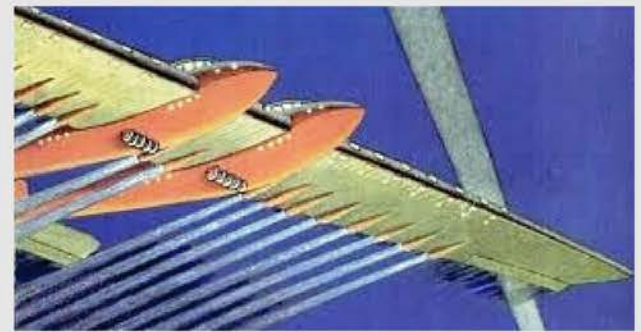
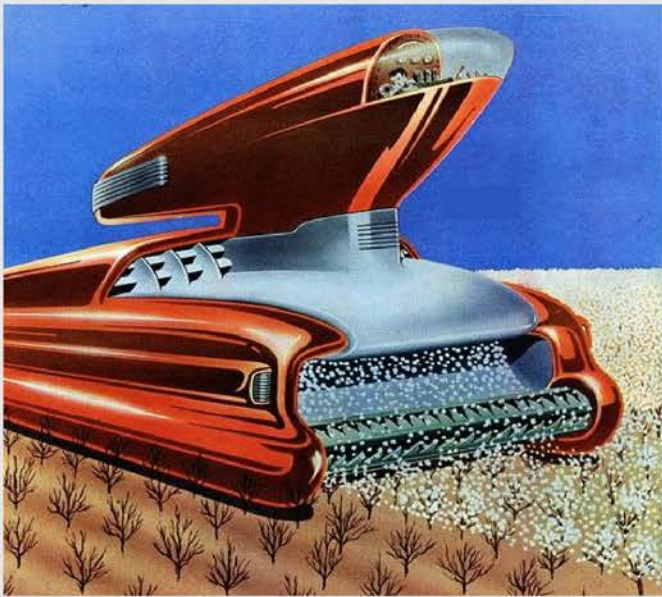
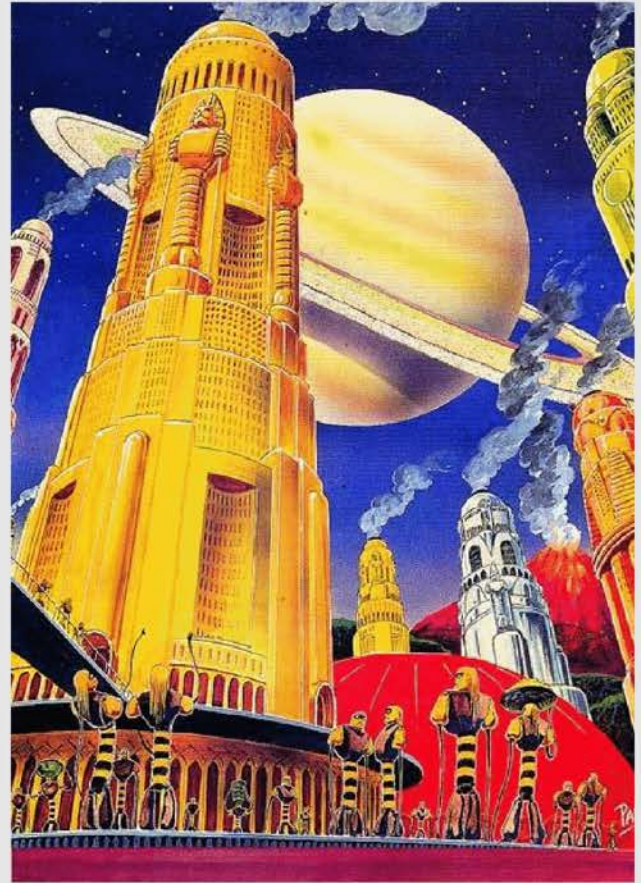
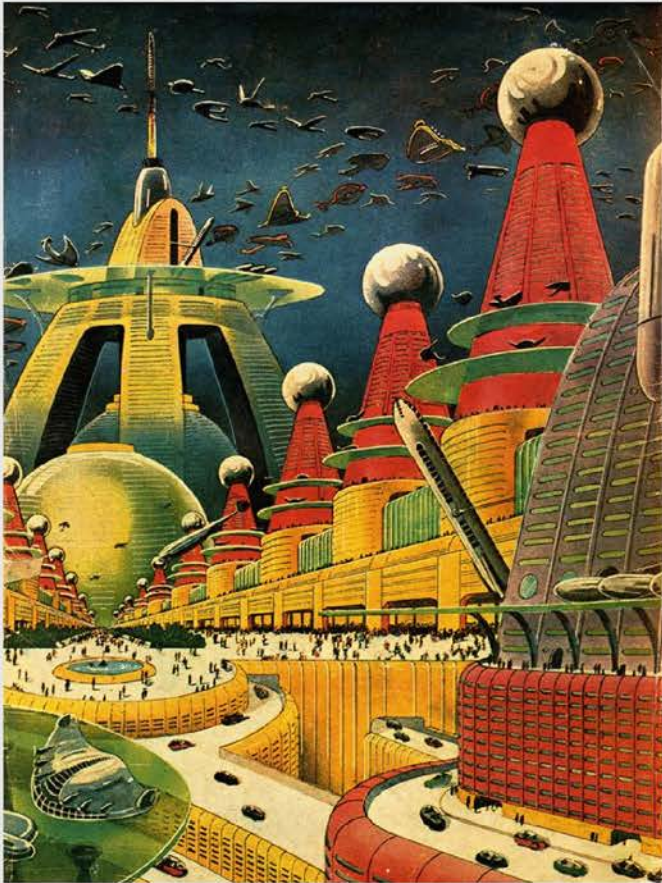

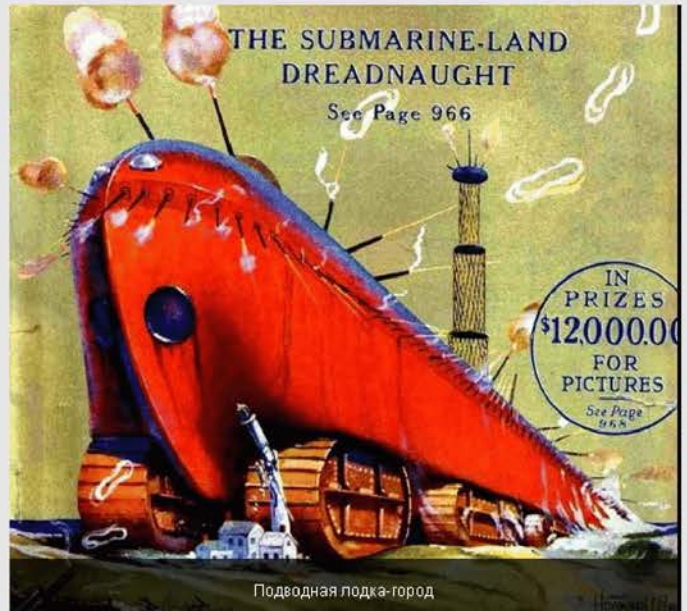
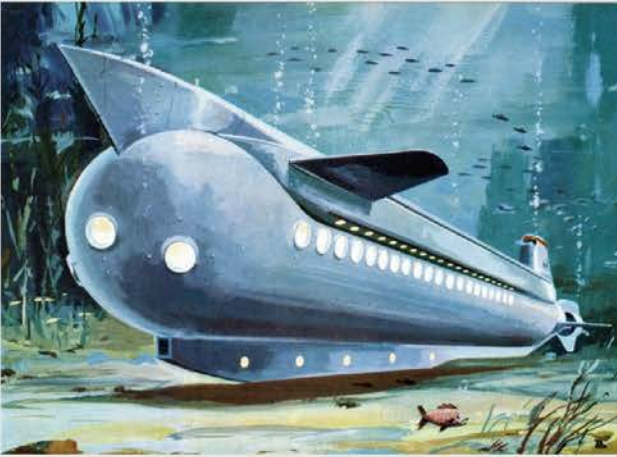



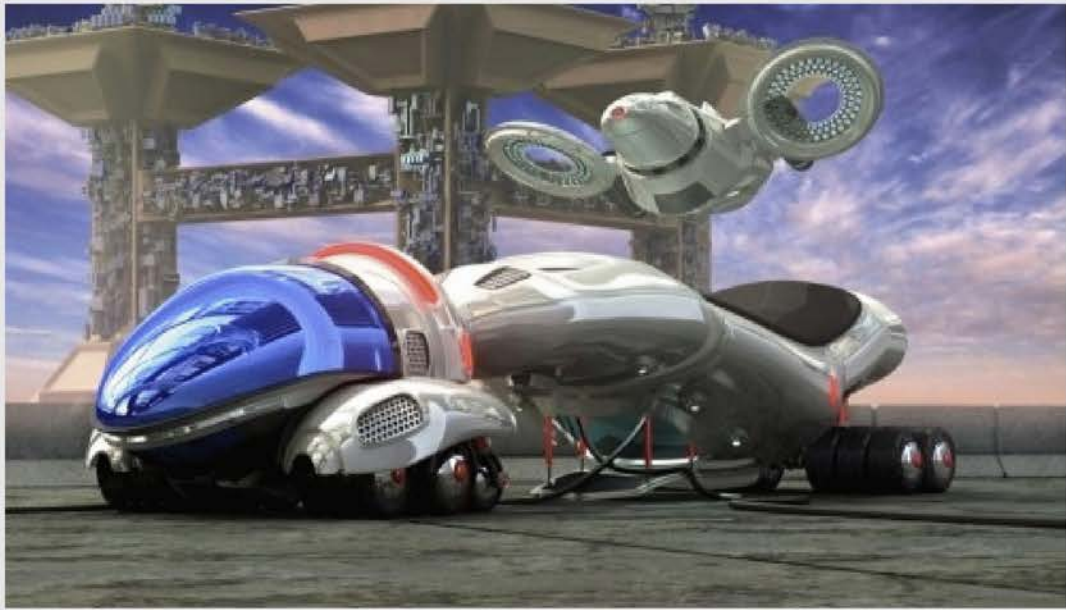



Helicopters for Everybody

The Hoppicopter is evolving into a comfortable single-seat helicopter that will supply you with cheap air transportation.

By Frank Tinsley

BACK in the 30's, a Seattle aeronautical engineer named Horace T. Pentecost became convinced that he could design a set of personal wings. As an engineer and student of aviation history, Pentecost was well aware of the shortcomings of man-made flapping wings, so he gave the problem an entirely different solution. In place of rosy pinions, he substituted the whirling blades of the modern helicopter. His first machine, designed for army

paratroopers, was intended to supplant the clumsy and uncontrollable parachute. Strapped to the wearer's back, it was christened "Hoppicopter" because the trooper literally hopped off and landed on his own two feet. It consisted of little more than an engine, rotors and control stick, mounted on a tubular frame that was strapped over the flier's shoulders and back.

The Hoppicopter's dependence upon human legs as landing gear proved its

FRANK TINSLEY '39



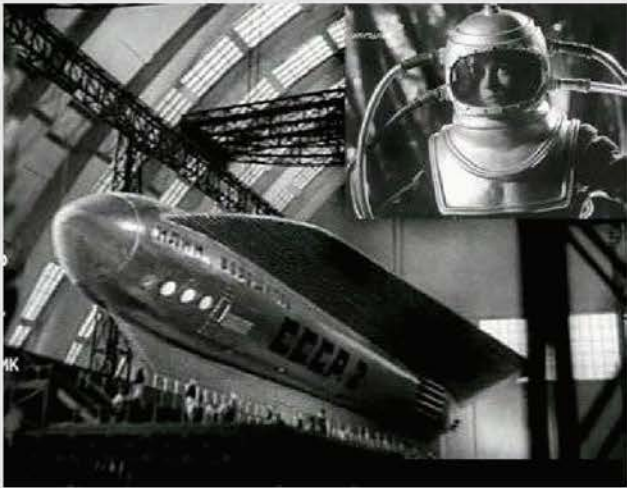



ПРОМЫШЛЕННЫЙ ДИЗАЙН



ЧАСЫ















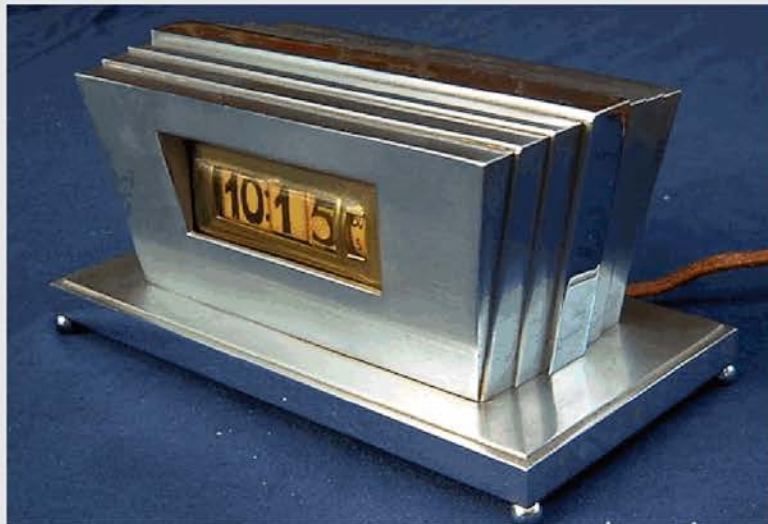























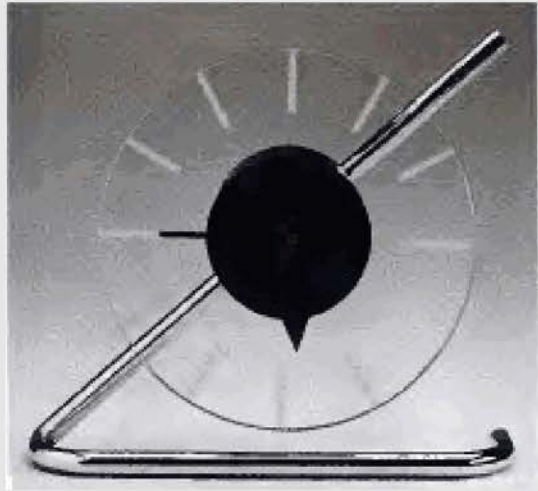





СВЕТИЛЬНИКИ













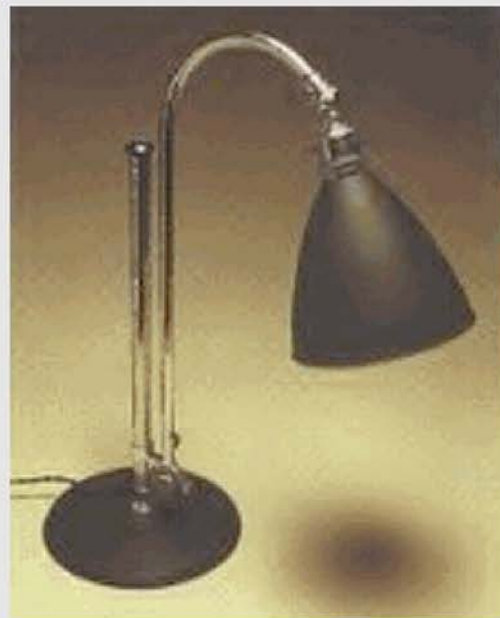







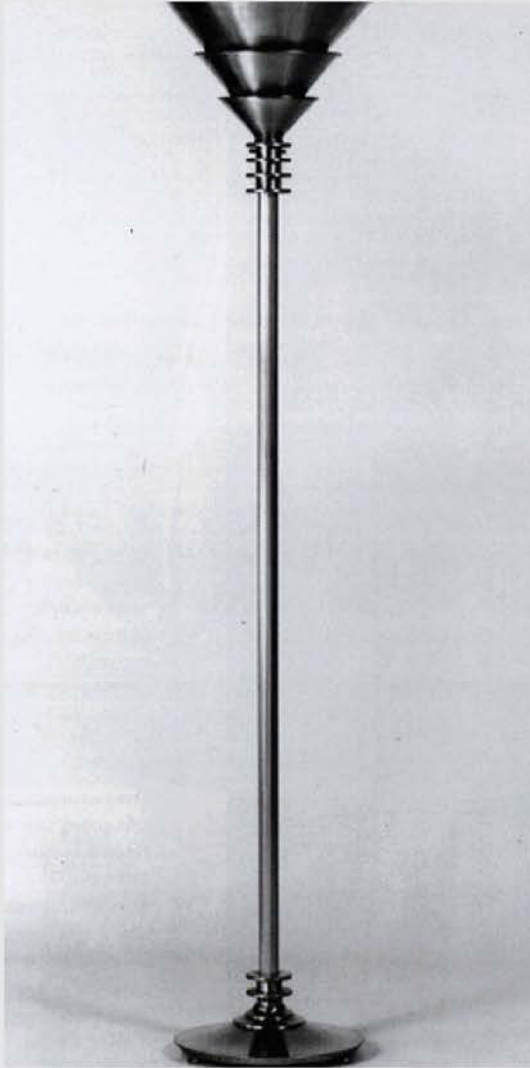

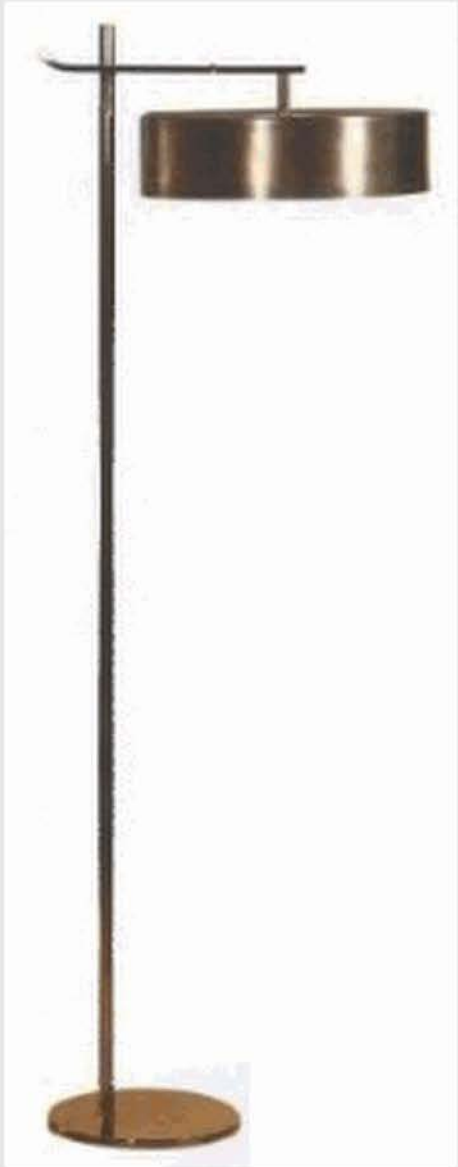





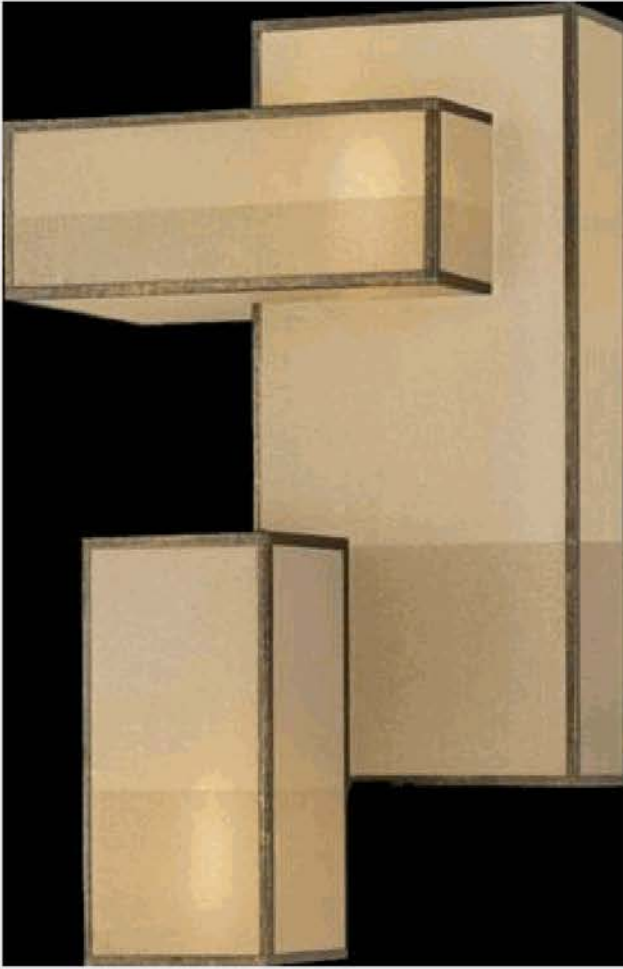

















ЗАЖИГАЛКИ





КАНЦЕЛЯРСКИЕ ПРИНАДЛЕЖНОСТИ









ТЕЛЕФОНЫ







Service and Equipment Manual
Commercial Department
S.W. B. T. Co.

Part III, Section
Exhibit
11

telephones in **COLOR**



Plastic telephones to harmonize with home or office decorative schemes are available in the five colors illustrated below. Metallic telephones in color are available on special order. Dial finger wheels are transparent.



DARK GOLD
METALLIC



IVORY
PLASTIC



STATUARY BRONZE
METALLIC



PEKIN RED
PLASTIC



GRAY GREEN
PLASTIC



OLD BRASS
METALLIC



DARK BLUE
PLASTIC



OLD ROSE
PLASTIC



OXIDIZED SILVER
METALLIC



THE STANDARD TELEPHONE SYSTEM

NEW LOOK for

-  BLACK
-  YELLOW
-  RED
-  BROWN
-  LIGHT YELLOW
-  BLUE
-  GREEN
-  DARK BROWN



EXTRA-THIN TELEPHONE Shows and shows all these profiles. Edge, corners and sides of 1/8". One piece body construction. Edge, horns and easy handle.

... PLUS extra conveniences



SMALL SIZE TELEPHONE Just a 1/2" thick and 1/2" high. Perfect for use in small spaces. Also for use in homes, schools, offices, hotels, restaurants, etc. It's the only one that fits in a telephone.



PHONE WITH TELEPHONE Shows better than any other. Features: Built-in cord, extra wide opening for use in narrow spaces. Also for use in small spaces with improved hearing.



NEW IN TELEPHONE For use in offices, hotels, homes, schools, restaurants, etc. Features: Built-in cord, extra wide opening for use in narrow spaces. Also for use in small spaces with improved hearing.



TELEPHONE ACCESSORY All types of accessories, including: extra wide opening for use in narrow spaces. Also for use in small spaces with improved hearing.



ПИШУЩИЕ МАШИНЫ







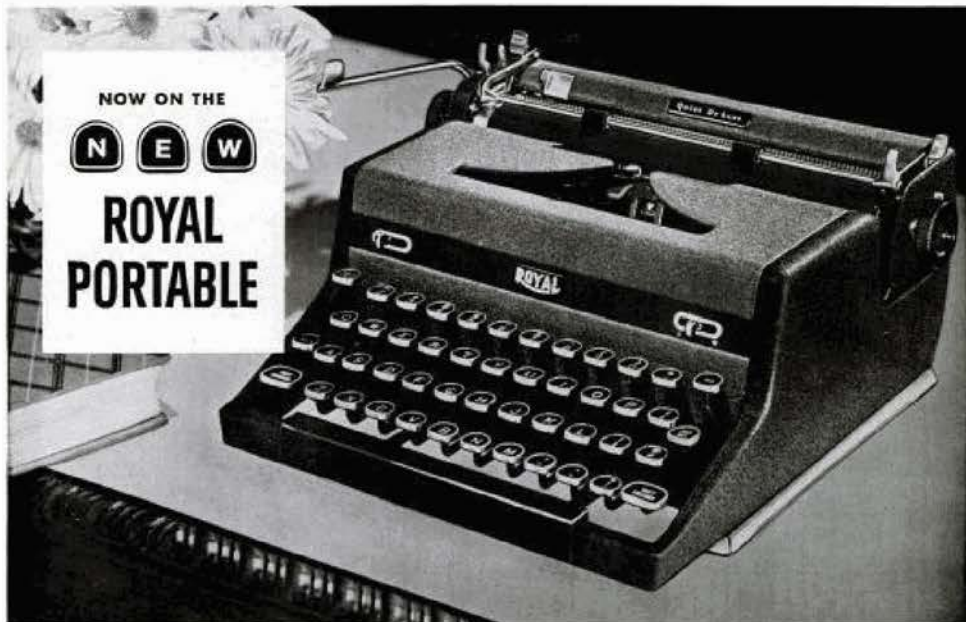

NOW ON THE
N E W
ROYAL
PORTABLE

FINGER FORM KEYS...

designed to cradle your finger tips!

The New Royal Portable introduces the most dramatic typewriter improvement in years . . .

FINGER FORM KEYS! Imagine a typewriter key which follows the very contour of your own finger! Specifically designed to cradle your finger tips when they strike the keys!

This remarkable Royal improvement brings a new comfort, a new ease of operation, a new speed to typing!

And the New Royal Portable—the most modern

typewriter ever designed—brings you so much more besides!

BEAUTY! Not merely beauty to look at and admire, but beauty put to work in a way that makes typing easier and faster!

Henry Dreyfuss, famous designer, incorporated his world-renowned styling into the New Royal Portable to help make it the *World's First Truly Modern Portable Typewriter!*

Many More Improvements!

SPEED SPACER! Built right into the framework of the typewriter! Only the New Royal Portable has it! With SPEED SPACER, there's nothing to impede spacing action . . . nothing to hurdle when using the space bar!

RAPID RIBBON CHANGER! Only Royal gives you this dramatic improvement which takes the fuss and mess out of installing a new ribbon!

"MAGIC" MARGIN! Only Royal gives you a margin-setting device which makes all other portable margin setting obsolete! Just position the carriage, flick your finger, and "Magic" Margin does the rest!

Literally, there are *dozens* of other features which make this Royal—more than ever—the World's No. 1 Portable! See the New Royal Portable at your dealer's. See the Portable so easy to look at . . . so easy to operate, that all others seem old-fashioned! Two models: The new Quiet De Luxe; The new Arrow.



THE NEW ROYAL PORTABLE

The World's First Truly Modern Portable Typewriter

"Magic" is a registered trademark of Royal Typewriter Company, Inc.

РАДИО



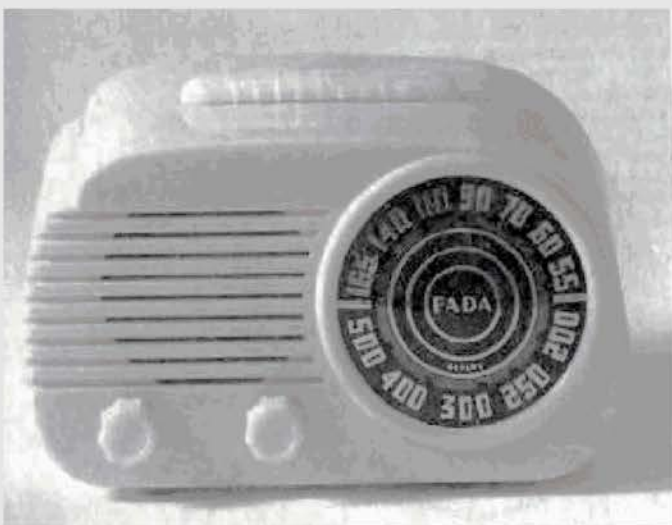
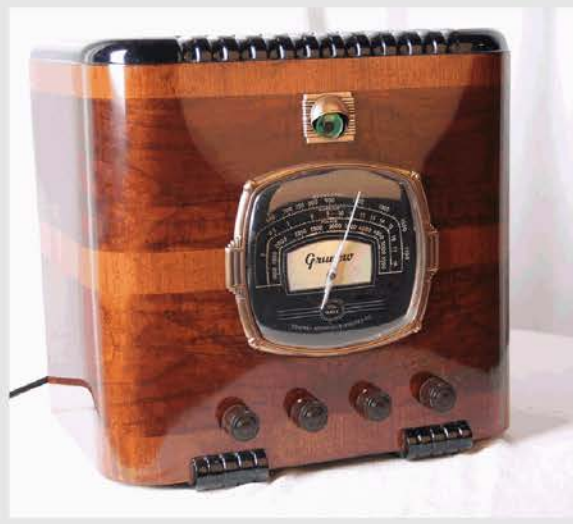







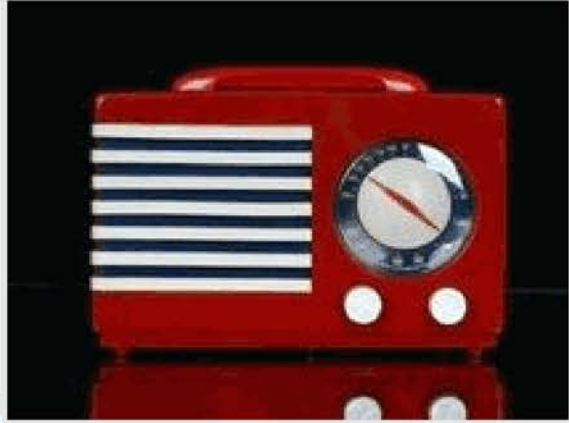



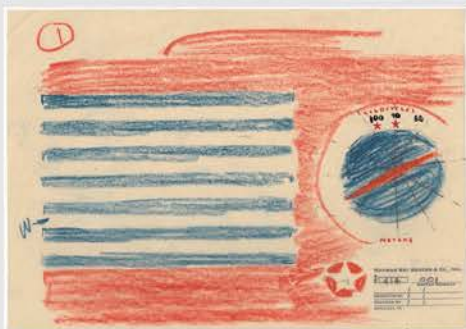





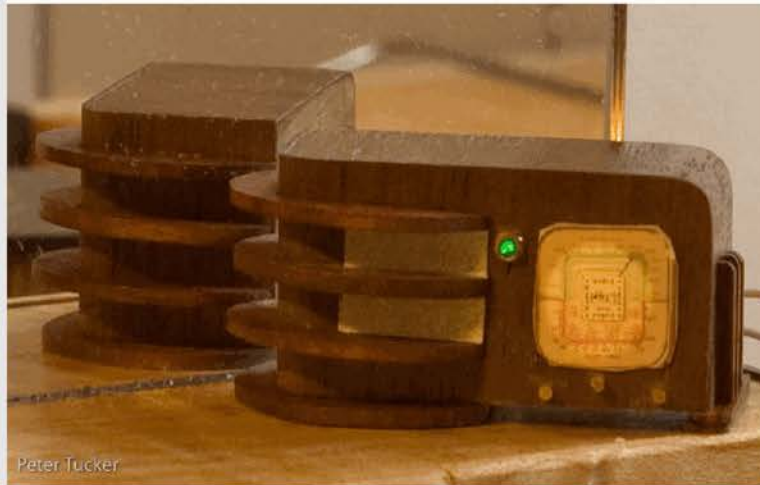



"Radio Nurse" Watches Child

A "RADIO NURSE" now brings the nursery into the living room, kitchen, or any other room desired. When a child is sleeping or playing in a room when no older persons are present, every sound within that room can be transmitted to any spot in the house. The outfit consists of a pickup unit, placed near the child to be "watched," and a loudspeaker, which can be placed in any convenient location.

formerly Modern Mechanix

71



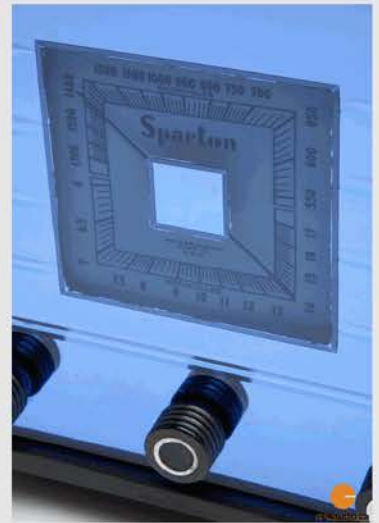
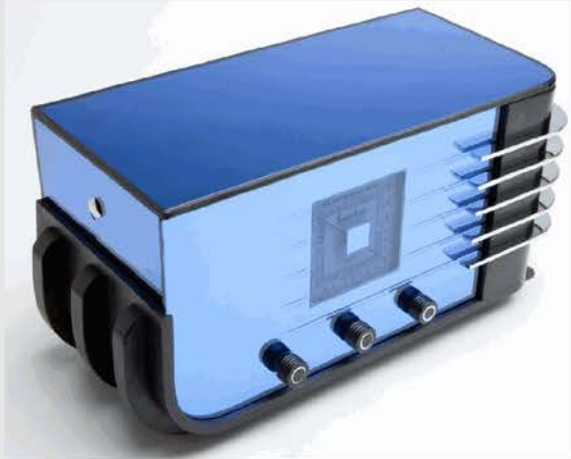

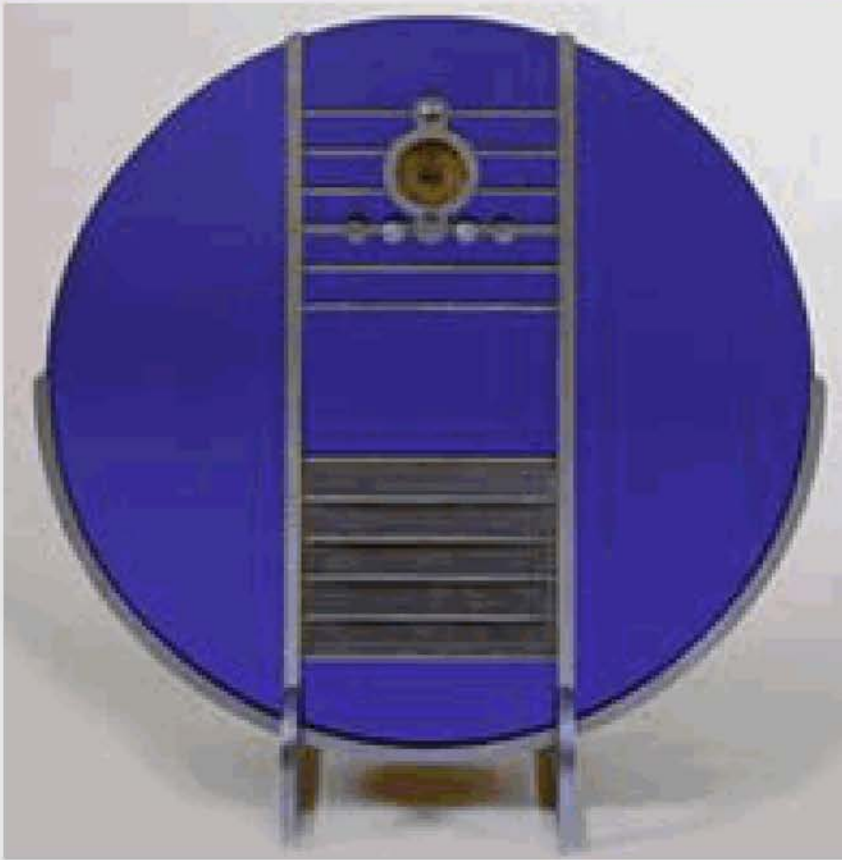















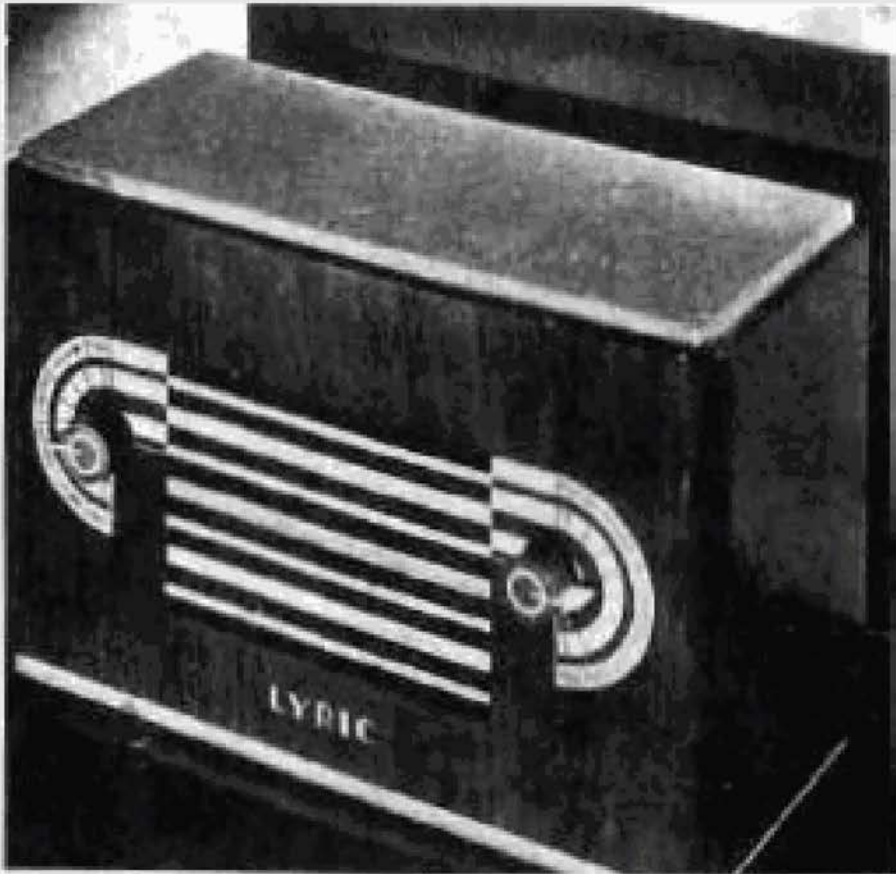

МУЗЫКАЛЬНЫЕ АВТОМАТЫ









ВЕНТИЛЯТОРЫ













ПЫЛЕСОСЫ





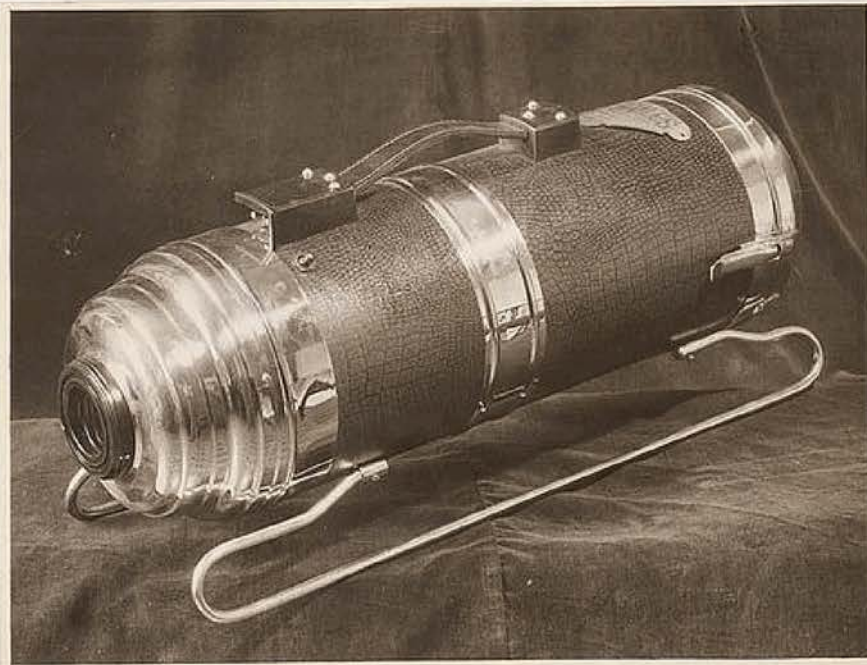
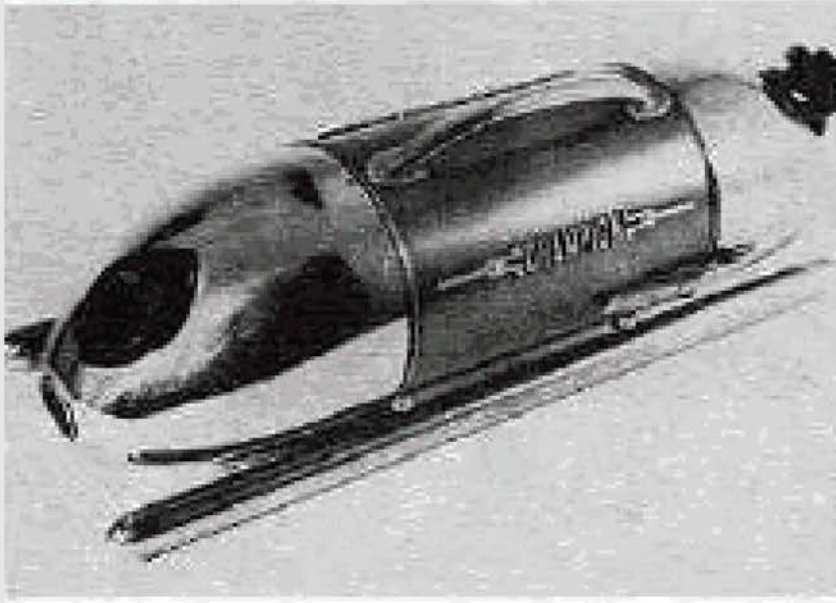









Hoover Convertible

with the *Automatic Shift*
and the
fastest pickup in cleaning!



It Beats...as it Sweeps...as it Cleans





ТОСТЕРЫ







УТЮГИ





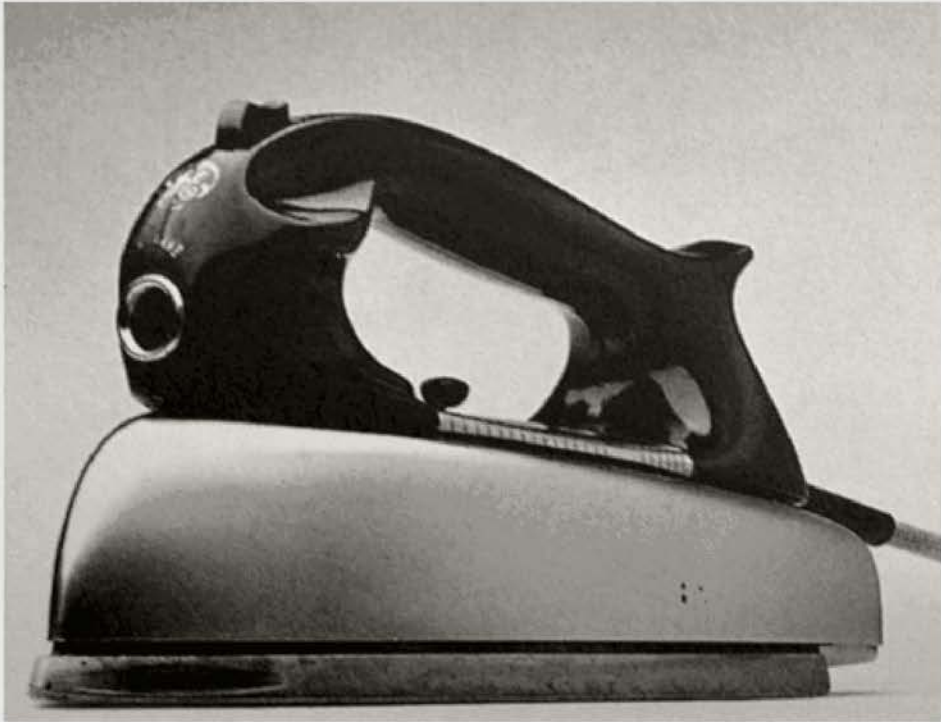

ПРОЧИЕ ЭЛЕКТРОПРИБОРЫ











СТИРАЛЬНЫЕ МАШИНЫ





ХОЛОДИЛЬНИКИ





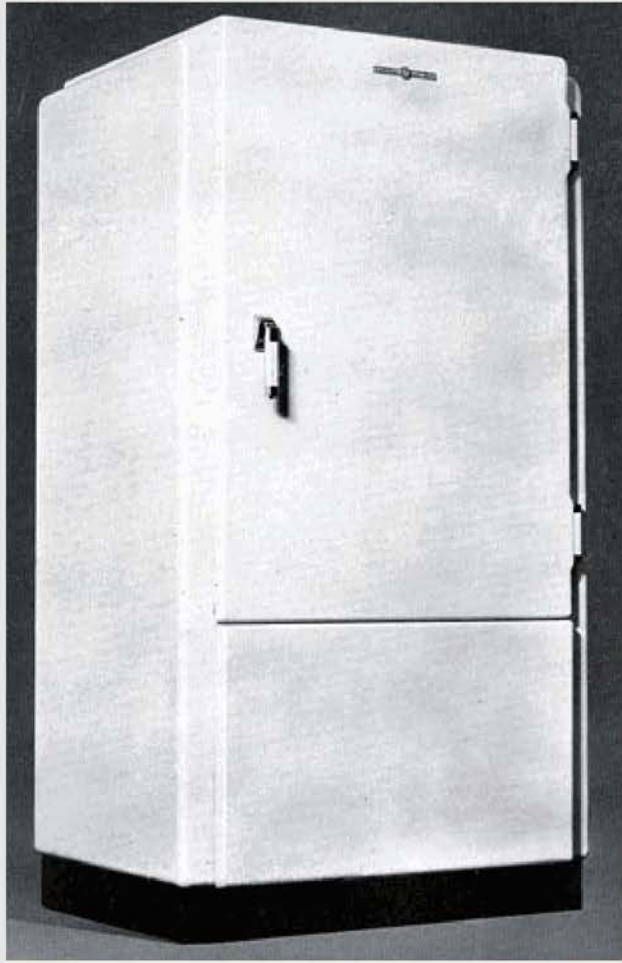





ΦΟΤΟΑΠΠΑΡΑΤΥ











РАЗНОЕ











Н.Н. Александров

ПРОМЫШЛЕННЫЙ ДИЗАЙН ЭПОХИ АРТ ДЕКО



2017

1152

Н.Н. Александров

УОЛТЕР ДОРВИН ТИГ

Walter Dorwin Teague



2017



АВТОМОБИЛИ

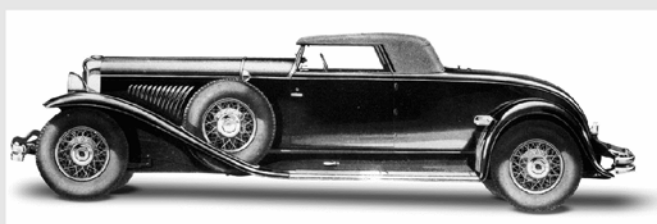



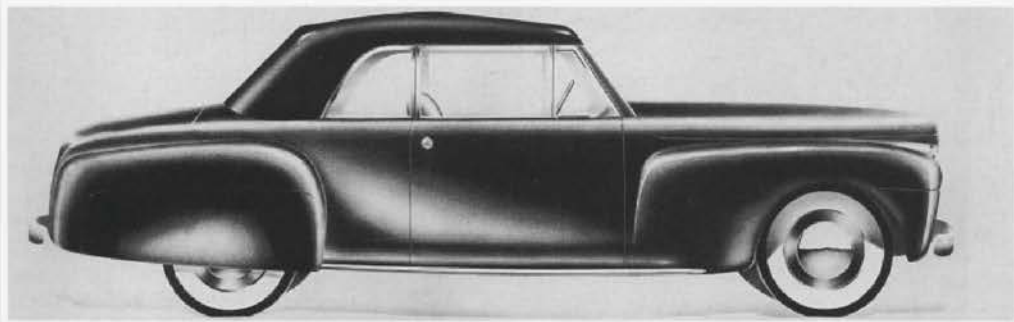
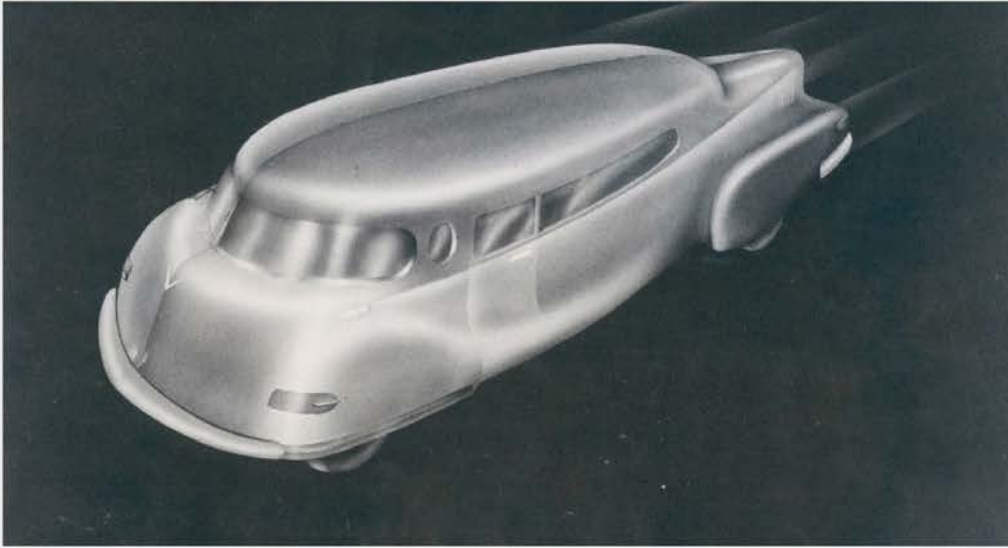
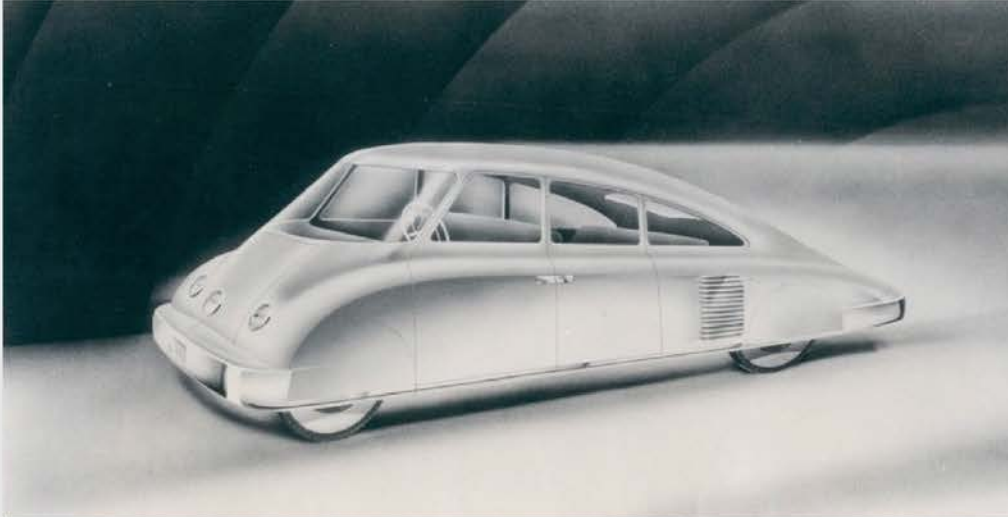

АРХИТЕКТУРА И ИНТЕРЬЕР



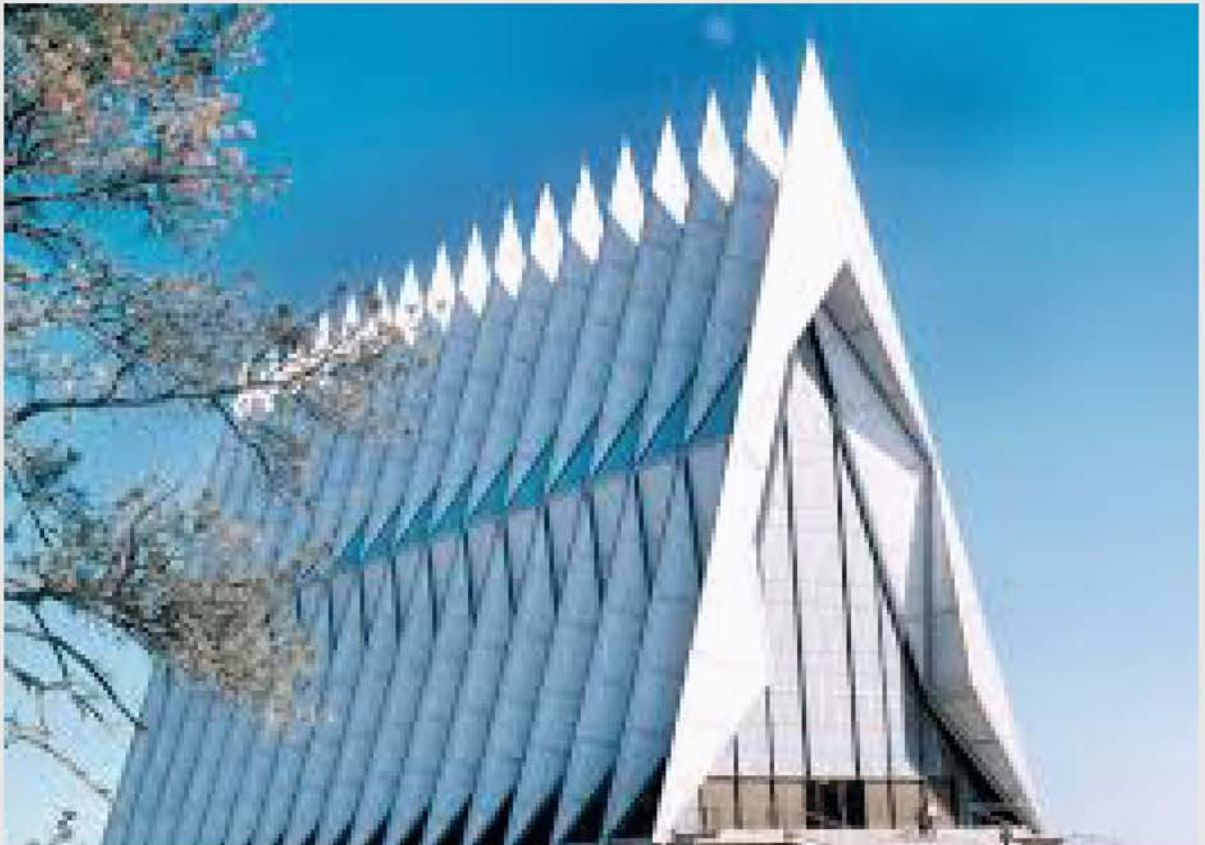







ДИЗАЙН ВЕЩЕЙ









МЕБЕЛЬ







ПОСУДА











ФОТОАППАРАТЫ КОДАК

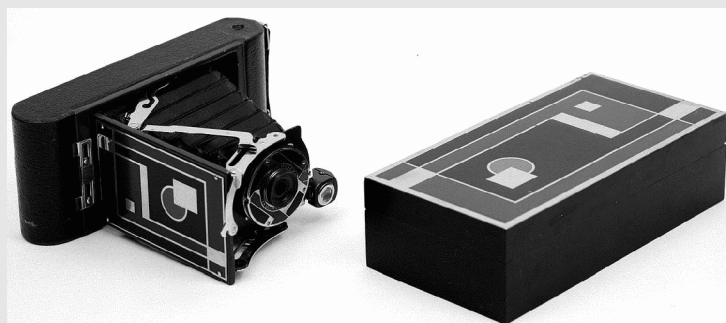



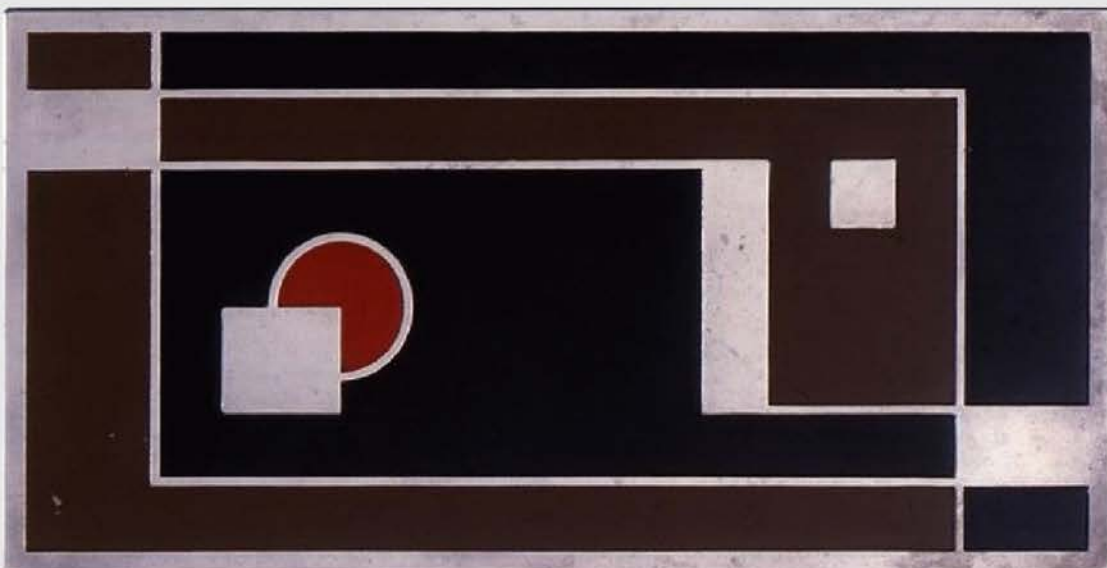



РАДИОПРИЕМНИКИ



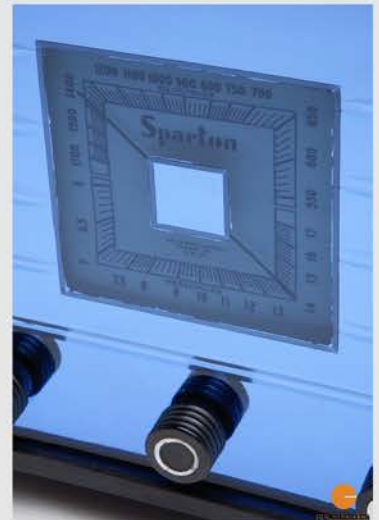











ПРИЛОЖЕНИЕ









Н.Н. Александров

Уолтер Дорвин Тиг

Альбом

2016

2017

Н.Н. Александров

РАЙМОНД ЛОУИ

Loewy Raimond

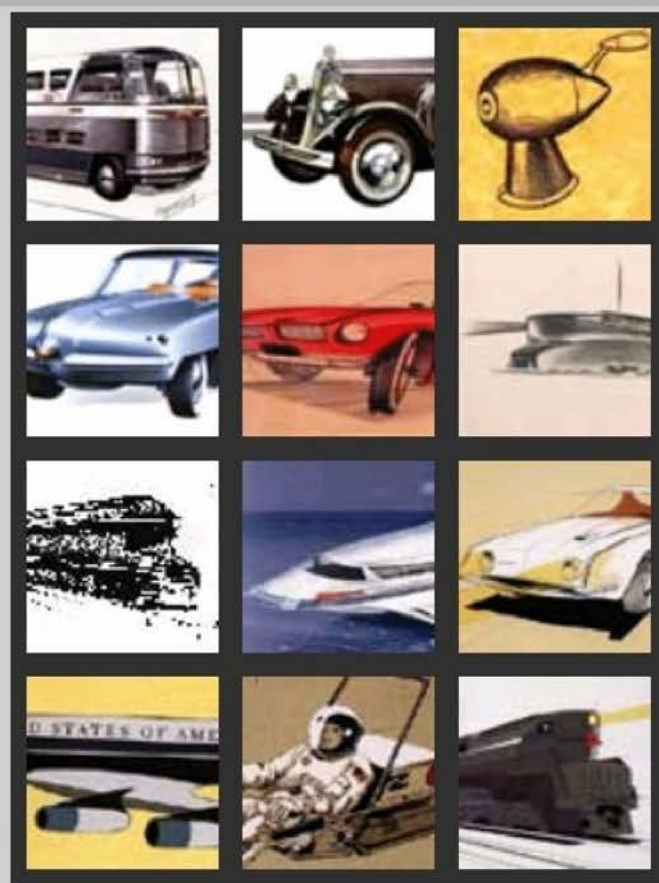

2017

ИНДАСТРИАЛ ДИЗАЙН

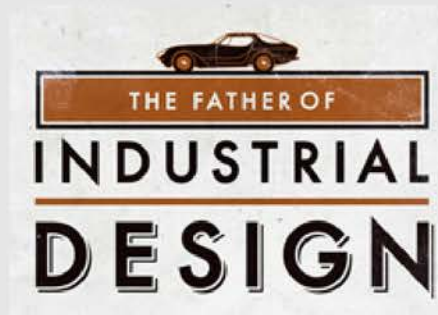

СРЕДСТВА ТРАНСПОРТА



ЖЕЛЕЗНАЯ ДОРОГА



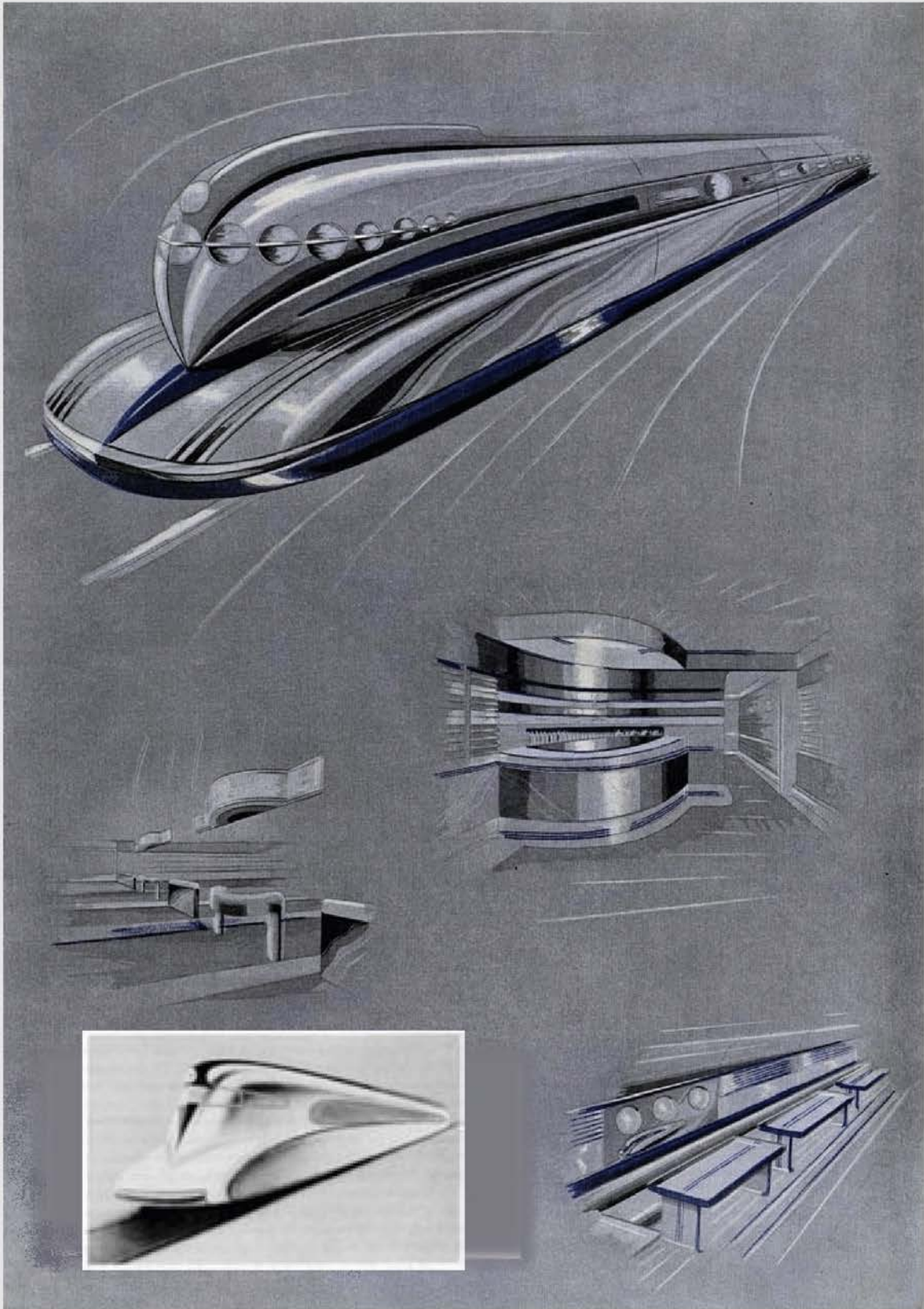









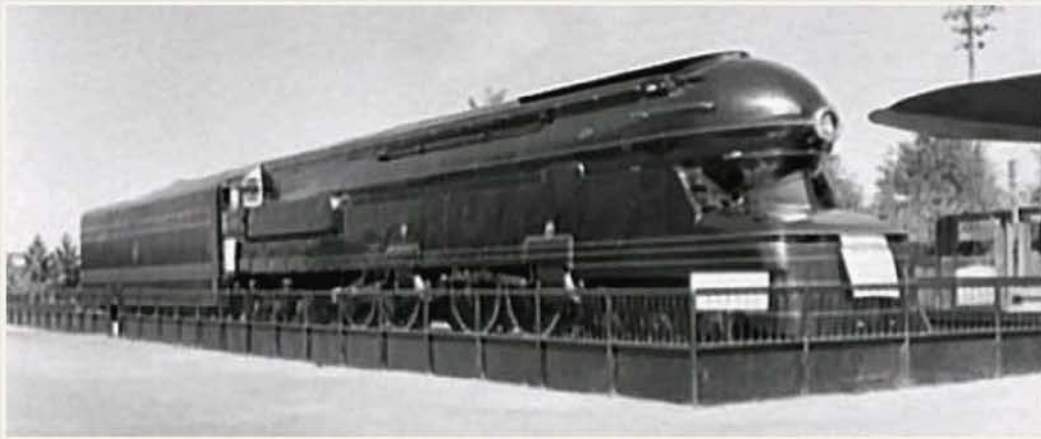





АВТОМОБИЛИ





One Car you can use for Most Everything

Whether your body wants to enjoy the open air and freedom of the "Jeep" Station Wagon, or you prefer the comfort and protection of a closed body, the "Jeep" Station Wagon is the answer. It's a car that can be used for almost anything you can think of. It's a car that can be used for almost anything you can think of. It's a car that can be used for almost anything you can think of.

Willys-Overland

Jeep Station Wagon
WITH TWIN BODY AND TOP

Willys-Overland's "Jeep" Station Wagon is a car that can be used for almost anything you can think of. It's a car that can be used for almost anything you can think of. It's a car that can be used for almost anything you can think of.













Студебекер супер клин кастом



Студебекер бизнес купе





Студебекер командер







Студебекер

THE NATIONAL BUSINESS NEWS November 15, 1956

This year—Craftsmanship makes the **big** difference in the low price field!

STUDEBAKER '57

only car in America with Supercharged Power, Twin Traction, Slipstream Styling



WE TALK OF ON THE LINE TO OUR ENGINEERS... the only way to have them is with specific. You're not to give us a low price car that's essentially way ahead of the rest. It was no small problem. But our men gave more and more without us they got into it. The idea of building better cars instead of more cars... Studebaker '57 is the quality answer. You who enjoy good workmanship will be delighted to discover in this fine car the true meaning of Craftsmanship with a Plan!

A thing to you from Studebaker
 This new Studebaker is the result of the continuing effort to give you the best in quality for your money. It's a car that's built to last, to give you the best in quality, to give you the best in value.

Customized
 In a car that will last.

Performance
 In a car that's thoughtfully built.

Reliability
 In a car that's thoughtfully built.

Studebaker
 STUDEBAKER-REO CORPORATION
 When you're looking for a car that's built to last.

* NEW STUDEBAKER SUPERCHARGED POWER. America's most powerful 1600 cc. engine, with 100-hp. torque at 3000 rpm. 1000 cc. Supercharged engine available. Price, \$1000.00. In the U.S.A.

* NEW STUDEBAKER SUPERCHARGED POWER. Building your choice of American Supercharged engine with 1600 cc. or 1800 cc. Supercharged engine. Supercharged engine available. Price, \$1000.00. In the U.S.A.

* NEW STUDEBAKER SUPERCHARGED POWER. Build the Supercharged 1600 cc. engine. Supercharged engine available. Price, \$1000.00. In the U.S.A.

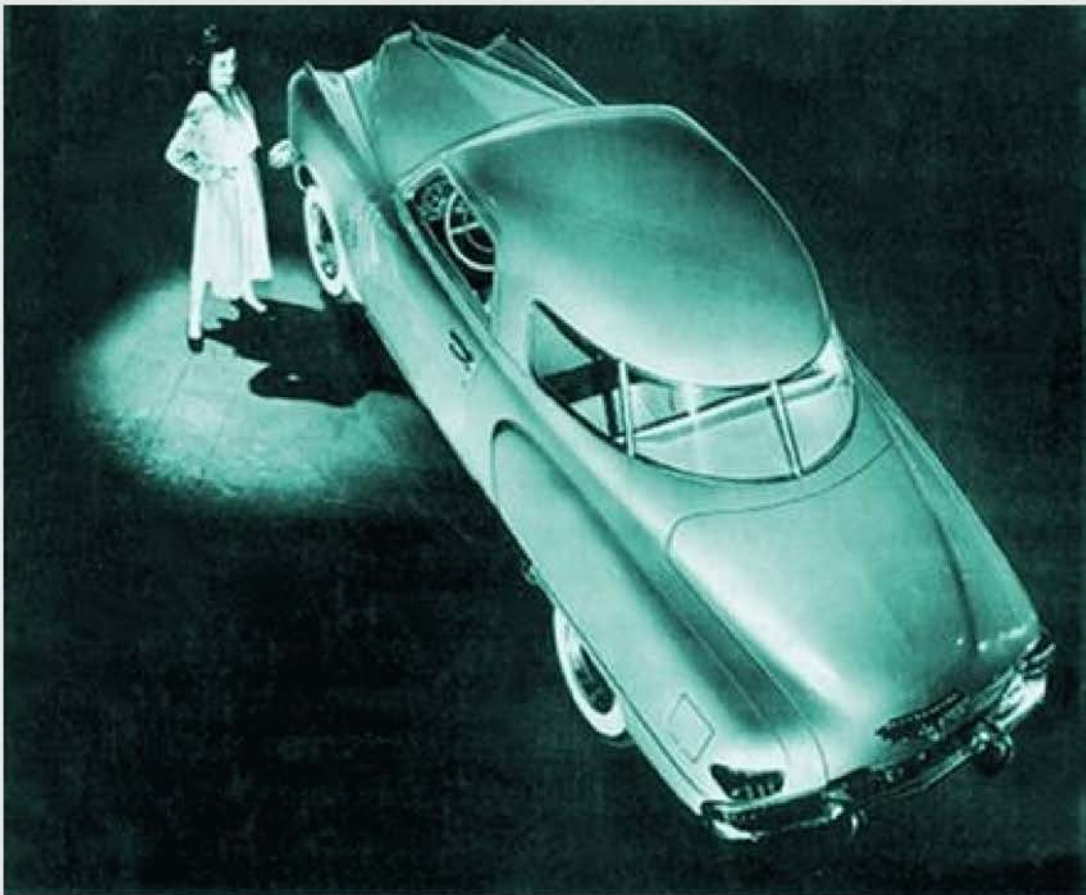

Кадиллак эльдорадо

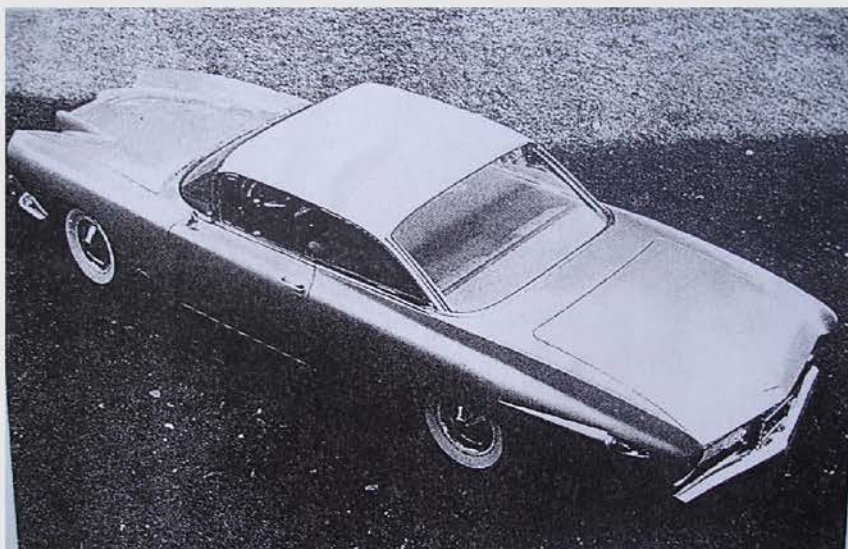

Аванти



PALM SPRINGS
Life
THE MAGAZINE OF THE DESERT EMPIRE

A photograph of a gold Avanti car parked on a paved area next to a swimming pool. The car is the central focus, with its sleek, aerodynamic design clearly visible. In the foreground, a man is swimming in the pool, and a woman in a yellow swimsuit is lying on a lounge chair. In the background, several tall palm trees stand against a clear blue sky. To the left, a few other people are visible near a building, suggesting a resort or hotel setting. The overall atmosphere is one of a classic, luxurious desert vacation.

JUNE, 1962 / FIFTY CENTS
PUBLISHED MONTHLY ALL YEAR

AVANTI — DESERT-DESIGNED CAR —
Light — Strong — Yucca Valley —
White — Blue — Low — Wide — Features

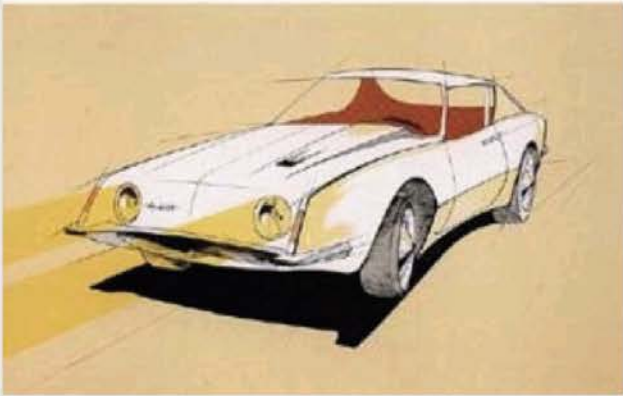



Ягуар





Ланча



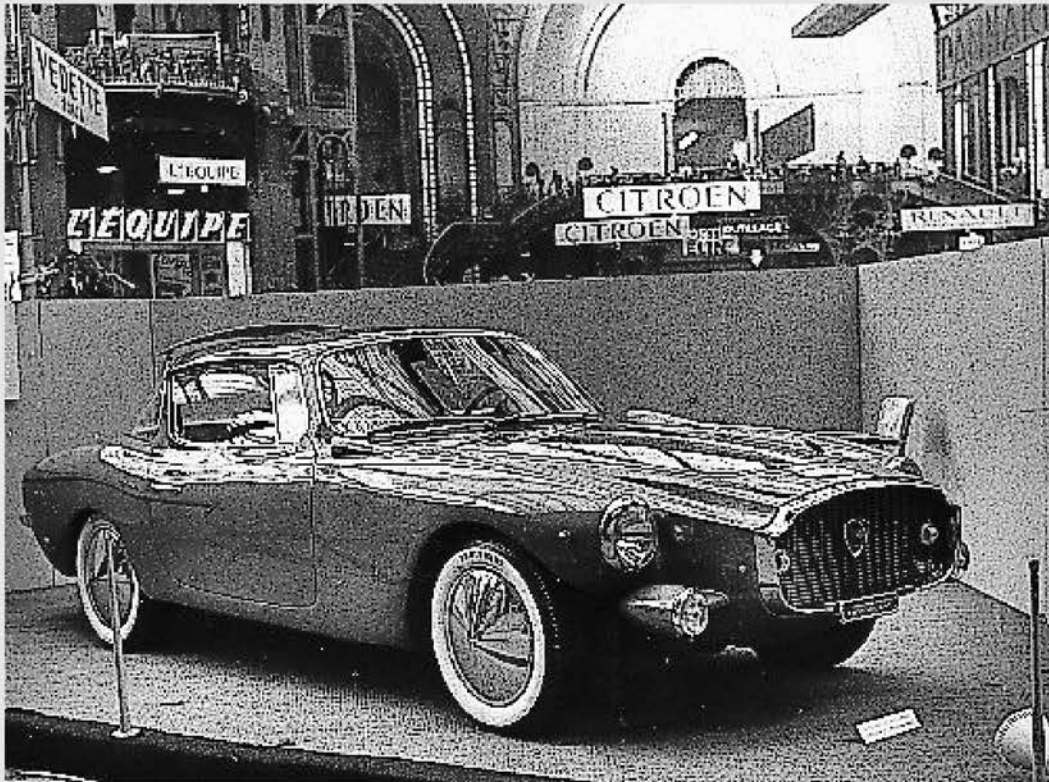

БМВ 507



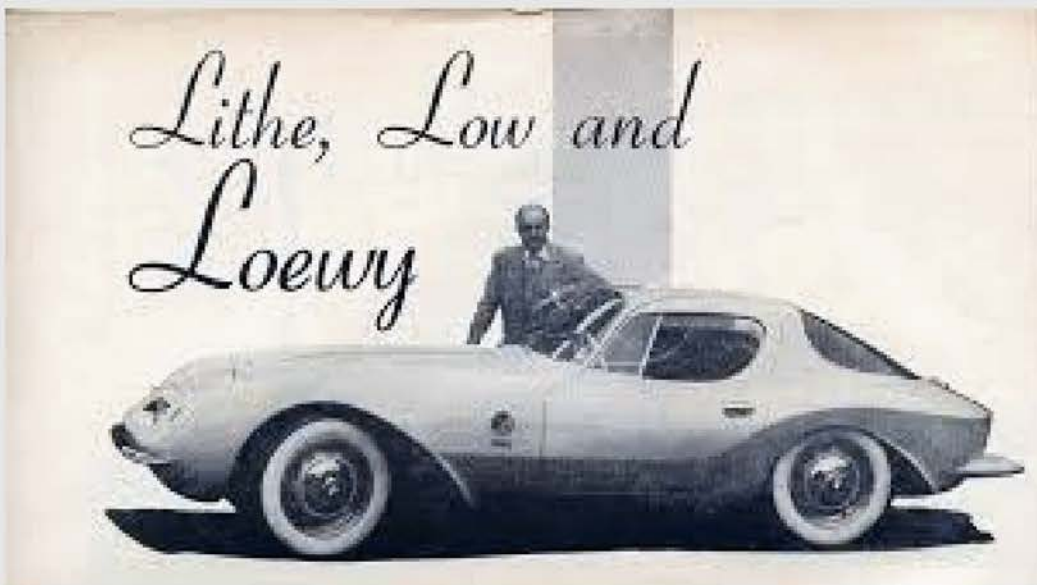

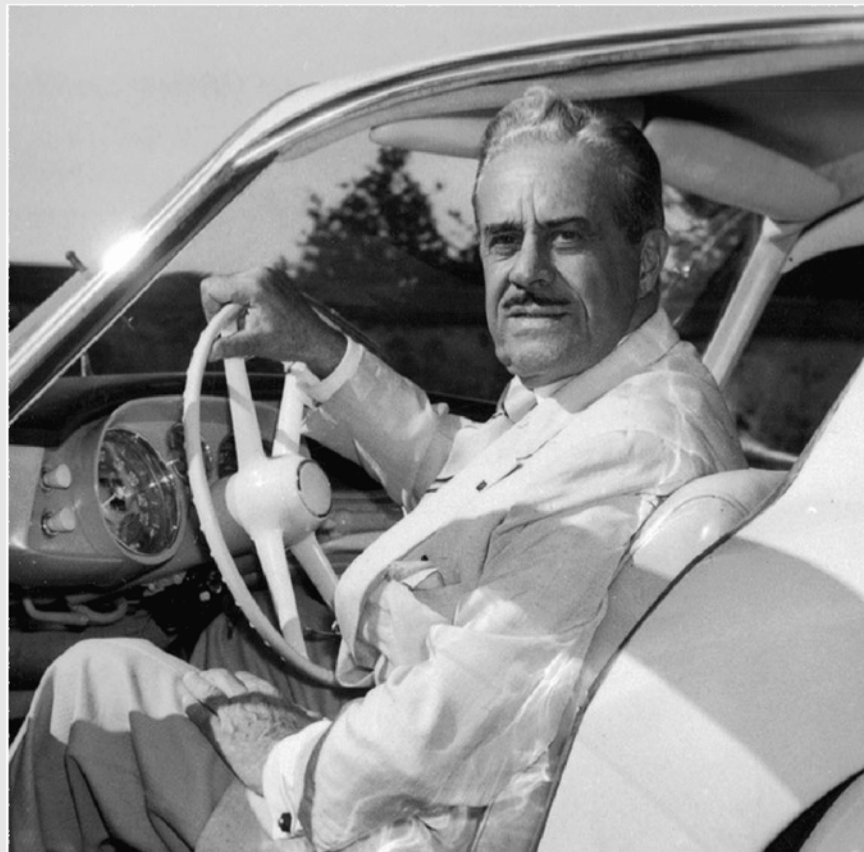
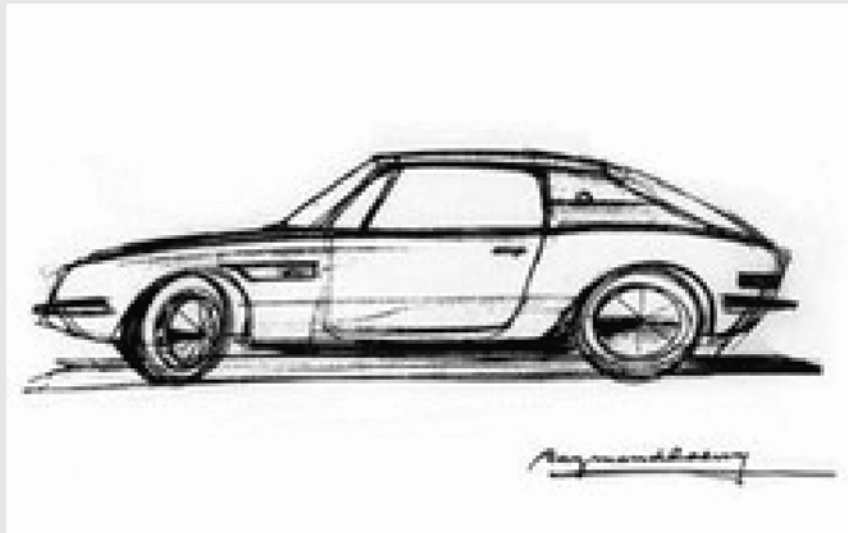

Багги



Мопед



Dec. 24, 1940. H. B. LEWIS ET AL. 2,225,914
 MOTOR VEHICLE
 Filed April 19, 1938 3 Sheets-Sheet 1

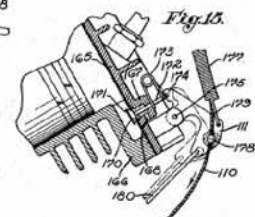
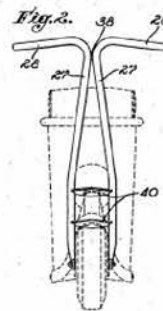
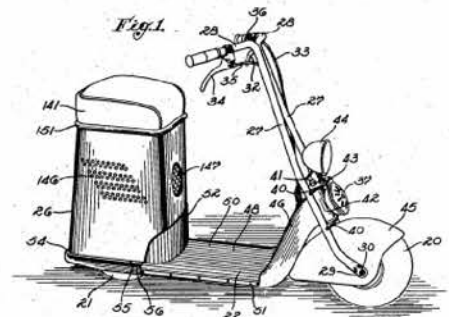
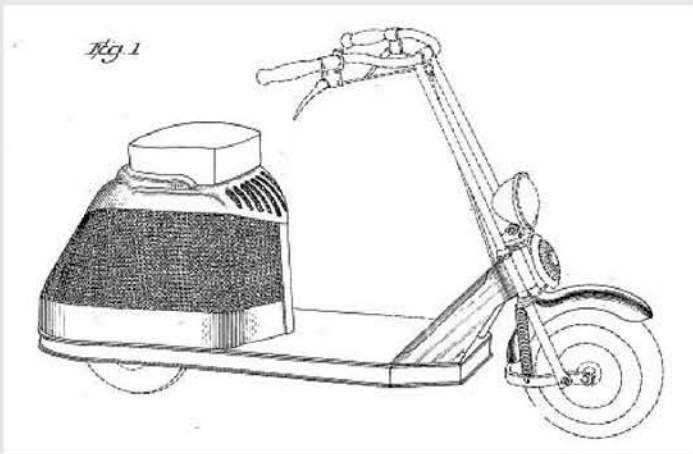

INVENTORS
 HOWARD B. LEWIS
 BRUCE BURNS
 AUSTIN E. LILMORE
 ESLEY F. SALSBURY
 BY HARRIS, KIEHN & HARRIS
Harris
 ATTORNEYS.

АВТОБУСЫ







Make it the *Time of Your Life* with a low-cost trip to sunny playgrounds—by Greyhound

How would you like a generous slice of Summer, sandwiched in between the Winter weeks . . . all spread with sunshine and spiced with good times? You can have it, going Greyhound—whether it's down Florida way, on the Gulf Coast, in the sunny Southwest, or on the Pacific Coast. That goes for gay days at Northern snow resorts, too. • The cost is lowest in travel—far less than driving your car—and you can relax, every scenic mile of the way. SuperCoaches are pleasantly warmed and ventilated—ony chairs tilt to any desired angle. Your trip will be *easy to take, easy to afford!*



From Florida to Texas, Greyhound serves all the delightful Gulf Coast. Plan to take in the Mardi Gras, New Orleans, February 24 to March 1.



Here's a State made-to-measure for Winter pleasure . . . East Coast, West Coast, right down to the Keys. Greyhound all the way, your choicest routes.



Winter's fun at snow resorts, too! Greyhound takes you so there in all the Northern and Mountain States.



California and Coast States—Arizona, Nevada, New Mexico, Texas—have the Winter sun is warm, scenery glorious.

GREYHOUND





Every mile a Magnificent Mile...

every highway a strip of velvet...



Complete Washroom—with wash basin, running water, toilet, other conveniences.

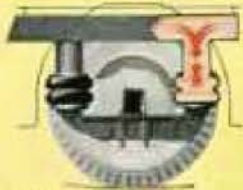

Air Suspension Ride—Entire coach floats on cushions of air, in rubber-nylon bellows.



"Highway Traveler" coaches also offer Air Suspension, huge picture windows.

when you travel in the amazing new

Scenicruiser.

Here's the finest, most luxurious motor coach ever built, with features of comfort and riding ease never before found in travel . . . the brilliantly-designed Greyhound Scenicruiser!

Scores are already in service, hundreds more on their way—and only Greyhound will operate these sensational coaches—raised-level, panoramic sight-seeing, tasteful appointments, unbelievably smooth operation (Scenicruiser actually floats on air).

GREYHOUND

FREE! FULL-COLOR PLEASURE MAP OF AMERICA WITH TOUR FACTS

Mail to Greyhound
Tour Dept., 71 W.
Lake Street, Chi-
cago 1, Ill., for full-
color trip-planning
map—with details
on 50 Greyhound
Expense-Paid Tours.

Name _____

Address _____

City & State _____

Send me special information on a tour to:

HG-10-54





ТРАКТОРА



Farmall Cub



Farmall Model M



САМОЛЕТЫ







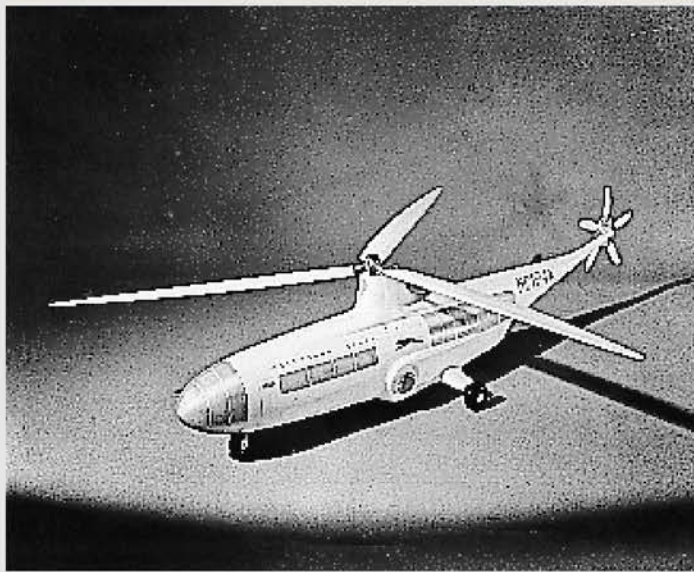



ЛОДКИ И КОРАБЛИ





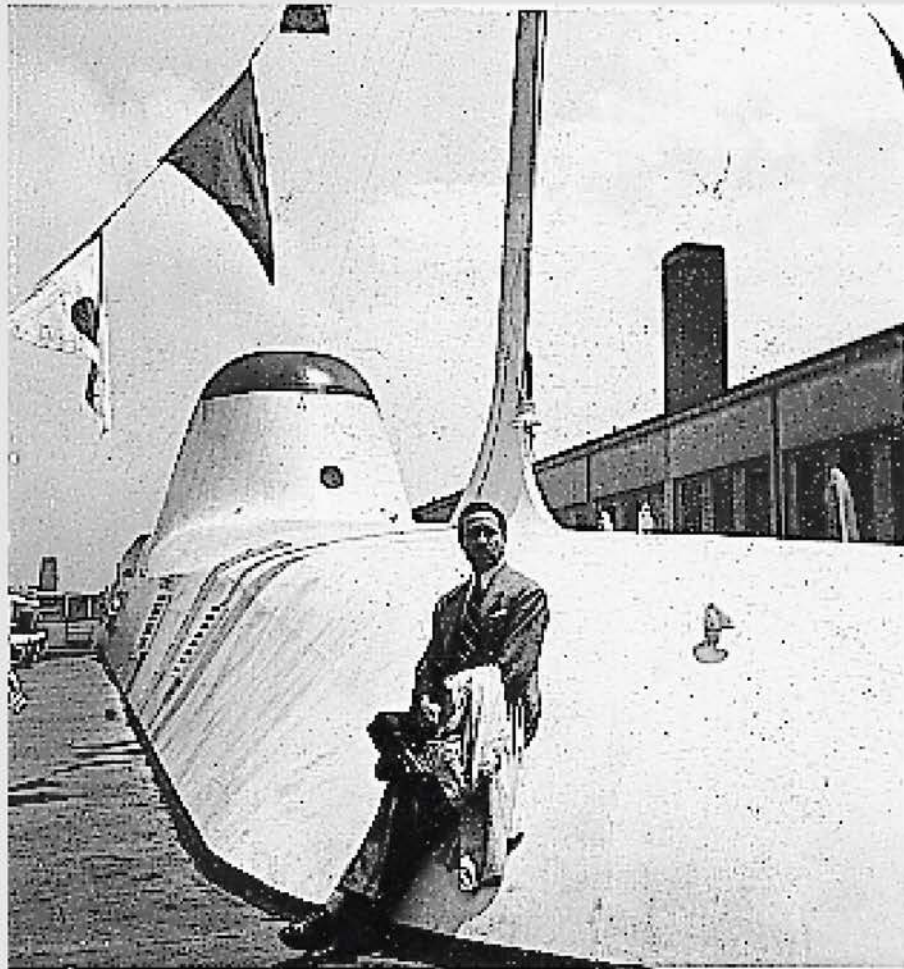

LOEWY

Dorsett '59

Loewy's Other Designs
YOUR FUTURE AFLOAT

What is MAYA?

АРХИТЕКТУРА И ИНТЕРЬЕР

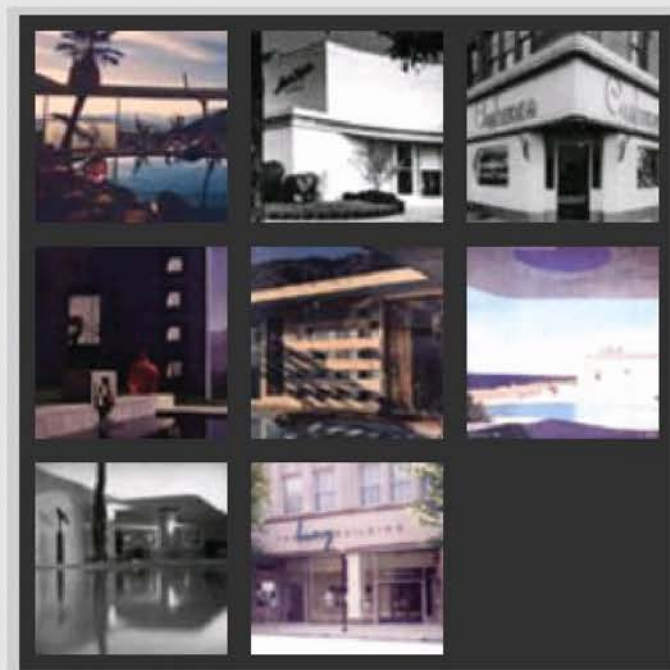



Raymond Loewy





LIFE
The Raymond Loewy House

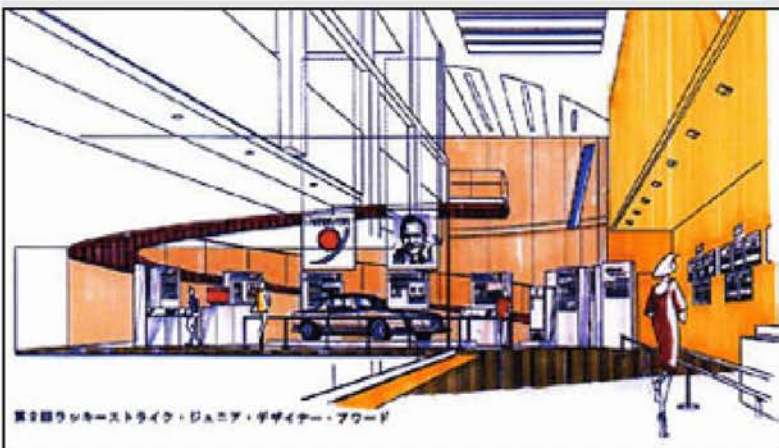



ПРОМЫШЛЕННЫЙ ДИЗАЙН



МЕБЕЛЬ









ПОСУДА











Raymond Loewy Limited Edition Coquelle Oven



Raymond Loewy

Originally designed in 1958 by famed industrial designer Raymond Loewy we have brought back this innovative rectangular 4.75 Qt. Coquelle oven as a limited edition item available for our 80th Anniversary Event.

Quantities are very limited so act quickly for best selection.

1958

Coquelle
FONTE ÉMAILLÉE



Raymond Loewy Limited Edition Coquelle Oven

Now you can own a piece of history.
4.75-Quart Coquelle Oven
available in Special Orange.

\$200.00







ΠΡΟΧΕΕ

A look into
your packaging future



Olin Cellophane Builds Markets

Raymond Lowry says: "To stay competitive in the American market today, most well-conceived packaging programs must include cellophane as a basic consideration."

"With more than 100 nationally distributed products, our client, National Biscuit Company, uses cellophane to solve a wide variety of problems. Among them: product visibility, quality color printing, product protection under varied climatic conditions, cost reduction, adaptability to high-speed production. To satisfy varying regional and individual consumer prefer-

ences, cellophane is used in all forms, plain and printed, bags, tray overwraps, box overwraps, bundling and unit packaging."

National, regional or local, your company's progress increasingly depends on thoughtful packaging decisions. An Olin packaging consultant will be glad to show you how Olin Cellophane or Polyethylene can help your profits grow. Film Division, Olin Mathliessen Chemical Corporation, 655 Madison Avenue, New York 21, New York.

A Packaging Decision Can Change the Course of a Business



As appearing in TIME Magazine



ХОЛОДИЛЬНИКИ

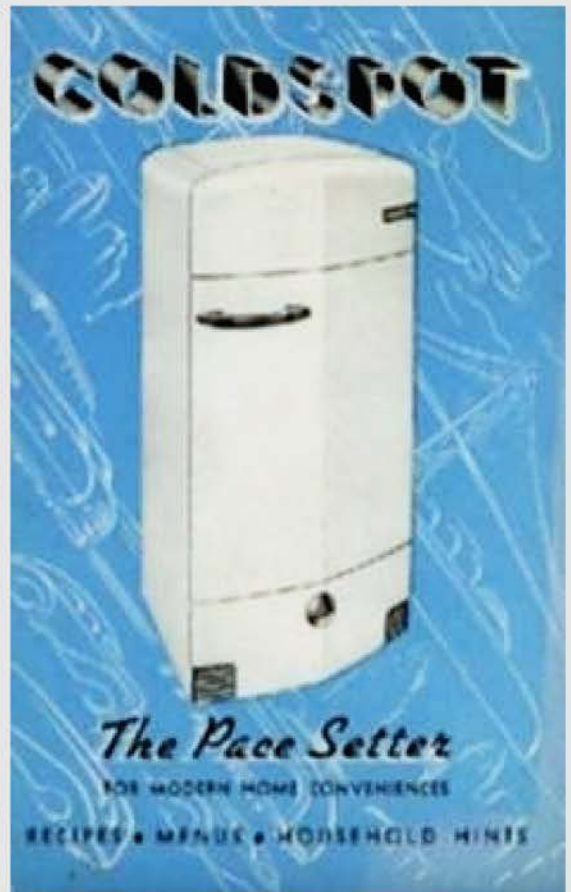
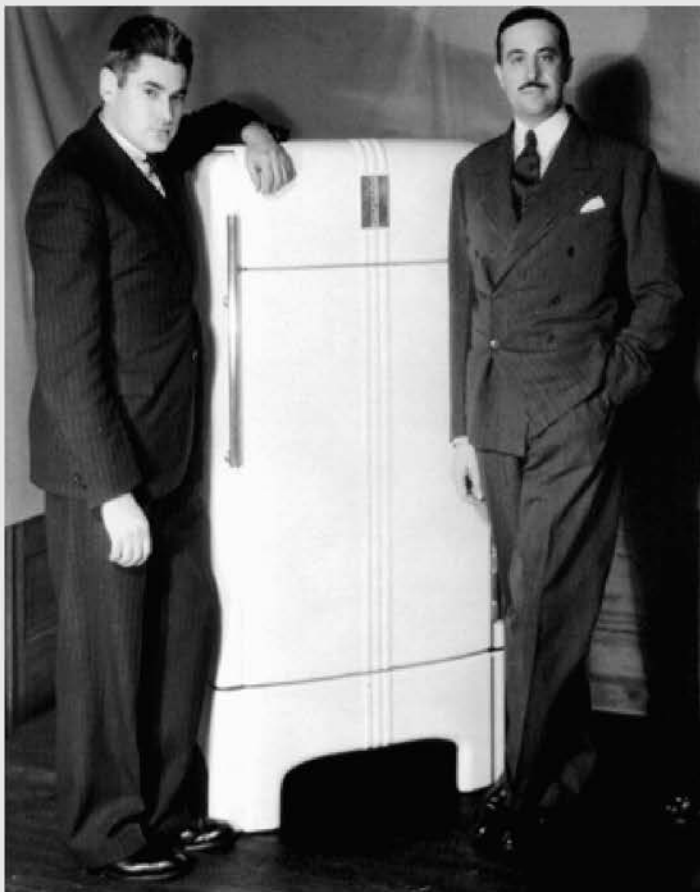

РАДИОПРИЕМНИКИ





Музыкальный автомат



ВЕЩИ И СТАНКИ



April 7, 1942.

R. F. LOEWY
ELECTRIC SHAVERS
Filed Jan. 29, 1942

Des. 131,928

Fig. 1.



Fig. 2.



Fig. 3.

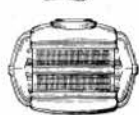

Raymond J. Loewy
INVENTOR
BY
Reginald Hicks
ATTORNEY

Oct. 4, 1938.

G. T. SCHARFENBERG
ELECTRIC SHAVERS
Filed March 24, 1938

Des. 111,574

Fig. 1

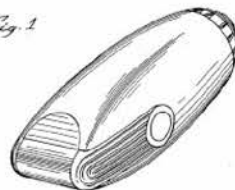

Fig. 2



Fig. 5

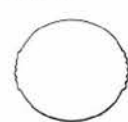

Fig. 3

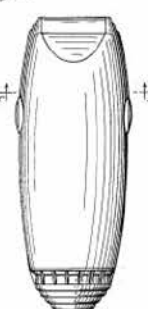
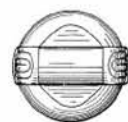
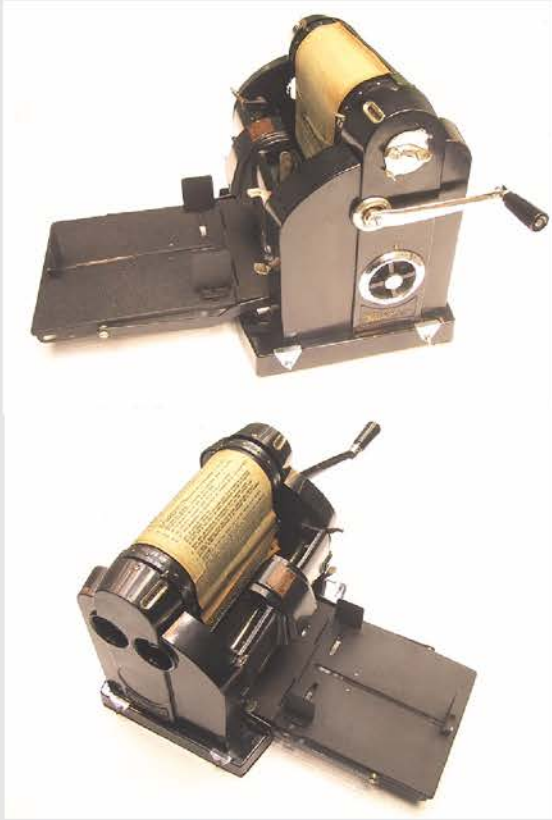
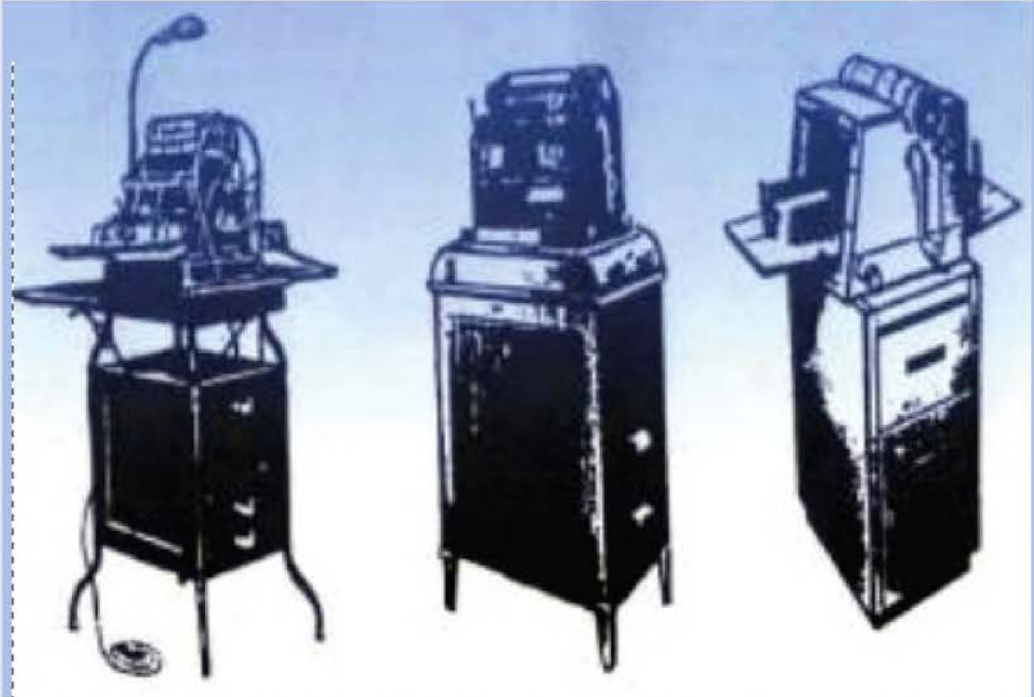

Fig. 4



Inventor:
George T. Scharfenberg
By
Wanna, Hiesterman & Dandach
Attys.





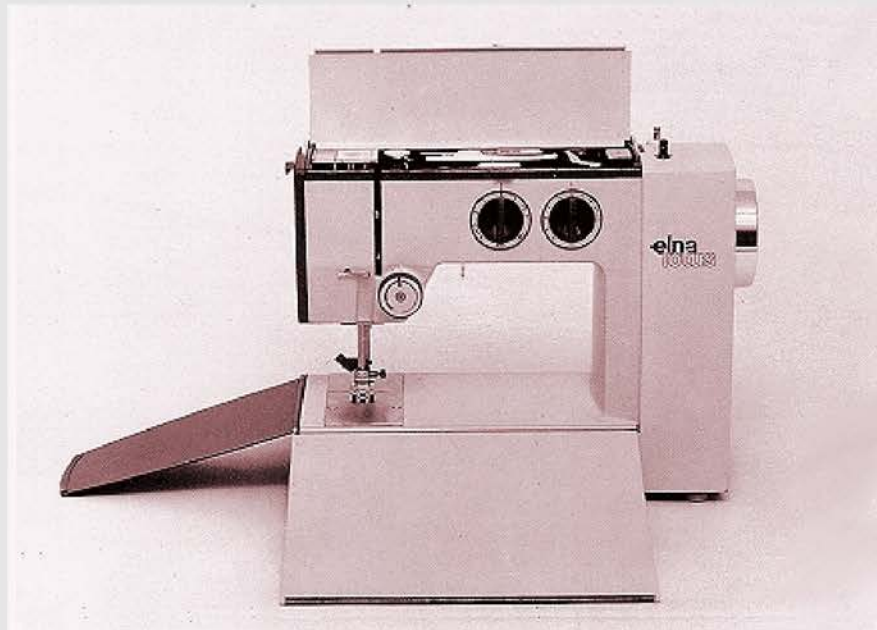
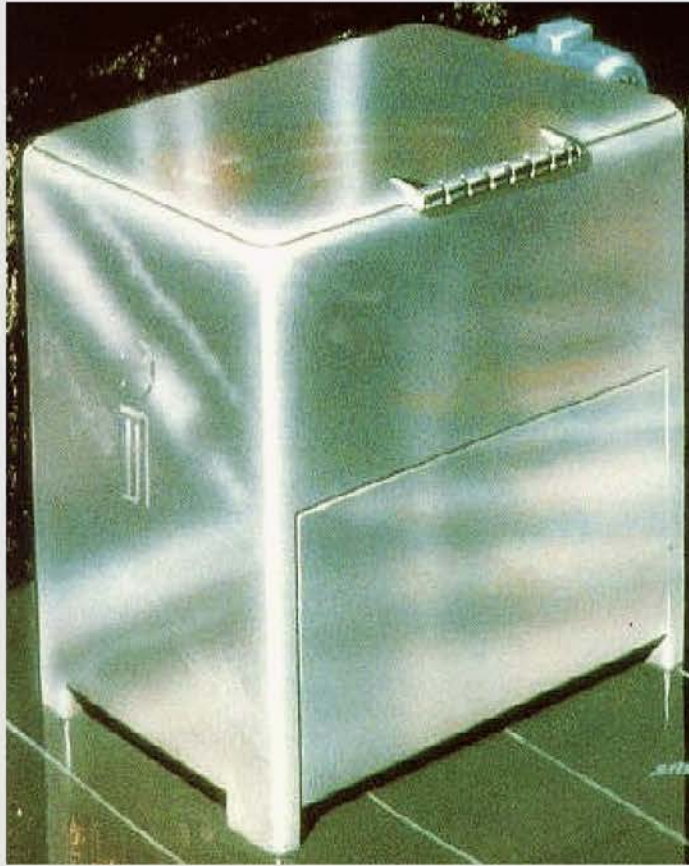



Raymond Lawry, world-renowned industrial designer (L.S. and J.S. Indigo, President of J. S. Indigo, Inc., for over a quarter of a century American importer for Rolex Watches, ask the popular question:



Where did you get your Rolex?

A common question between Rolex owners...for pride of possession creates a bond between them. It starts conversations, makes strangers friends. They praise such watchmaking achievements as the waterproof? Oyster case, the rotor self-winding *Perpetual* chronometer movement, the precision craftsmanship as well as the "inside and outside" difference that has made Rolex the finest and most distinctive timepieces in the world.

Rolex owners rarely comment on each other's taste. They don't have to. It's implicit in the fact that they both chose a Rolex.

"Rolex has produced more officially certified chronometers than all other manufacturers combined!"



ROLEX
OYSTER PERPETUAL

American Rolex Watch Corp., 880 FIFTH AVENUE, New York, N. Y.
Send for "Master Piece", Rolex's full-color booklet of ladies' and gentlemen's watches.



THE DAY DATE—Magnificent 18K gold Oyster Perpetual waterproof self-winding with 28-jewel officially certified chronometer movement. The day of the week and date appear in neat windows. Changes automatically at midnight. The date is magnified by the ingenious Cyclops lens for easy reading. With distinctive 18K gold President bracelet, REF. 1051 111.



Official time piece,
Pan American
World Airways.

100% ROLEX
SWISS MADE

ПРОМГРАФИКА И УПАКОВКА



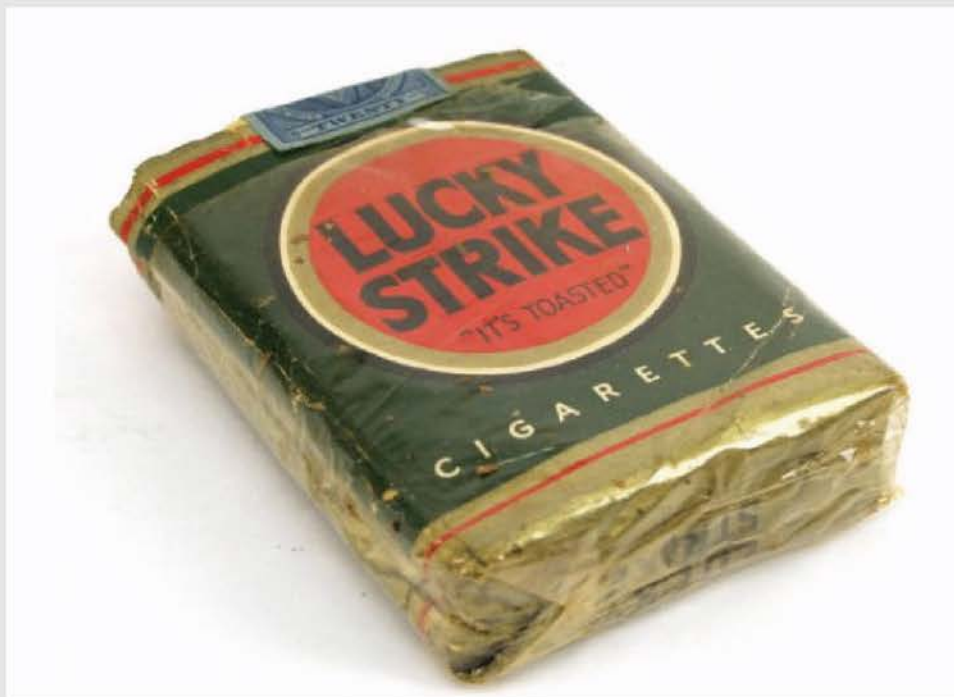

LUCKY STRIKE GREEN HAS GONE TO WAR!

So here's the smart new uniform for fine tobacco

"Man, that's fine tobacco"

...that's **LUCKY STRIKE** tobacco!

yes, **LUCKY STRIKE** means fine tobacco

L.S./M.F.T.

(Luckies taste better than...)

LUCKY STRIKE ALL AMERICA!

BUY DEFENSE BONDS

because...

LUCKY STRIKE IT'S TOASTED

CIGARETTES

L.S./M.F.T.

COPYRIGHT THE AMERICAN TOBACCO COMPANY

Be Happy - Go Lucky!

When fishing I just want to Luck. In sports do work do work. Portable because I also travel. L.S./M.F.T.

ENJOY YOUR CIGARETTE!... If you're not happy with your present brand (and a 38-city survey shows that millions are not), smoke Luckies! You'll get the happy blending of perfect mildness and rich taste that fine tobacco - and only fine tobacco - can give you. Remember, Lucky Strike means fine tobacco. So get complete smoking enjoyment. Be Happy - Go Lucky today!

As others are a little bit "off" they can't agree. But here in "Hickory Neck" Home W.L.S./M.F.T.

I've traveled around the whole wide world from New York to New York. And I can tell you Lucky Strike's the finest cigarette!

L.S./M.F.T. Lucky Strike Means Fine Tobacco

LUCKIES TASTE BETTER!

Cleaner,
Fresher,
Smoother!

Nothing - no, nothing - beats better taste

Most folks have so many reasons for smoking to keep their heads together... and they're right. It's in simple as that. So for the better taste - the cleaner, fresher, smoother taste - that only fine tobacco in a better made cigarette can give you...

But actually, there's only one good reason for smoking a cigarette - enjoyment. And you get enjoyment from only one thing - the taste of a cigarette.

Lucky Strike better... for two reasons. They're made of fine tobacco - long, light, mild tobacco - and they're made better. It's in simple as that.

Be Happy - **GO LUCKY!**

Copyright The American Tobacco Company

ЛОГОТИПЫ



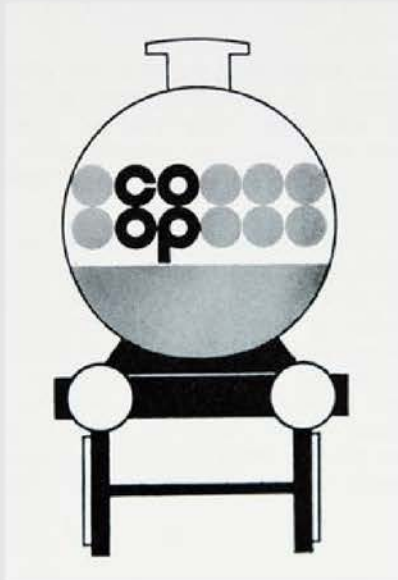

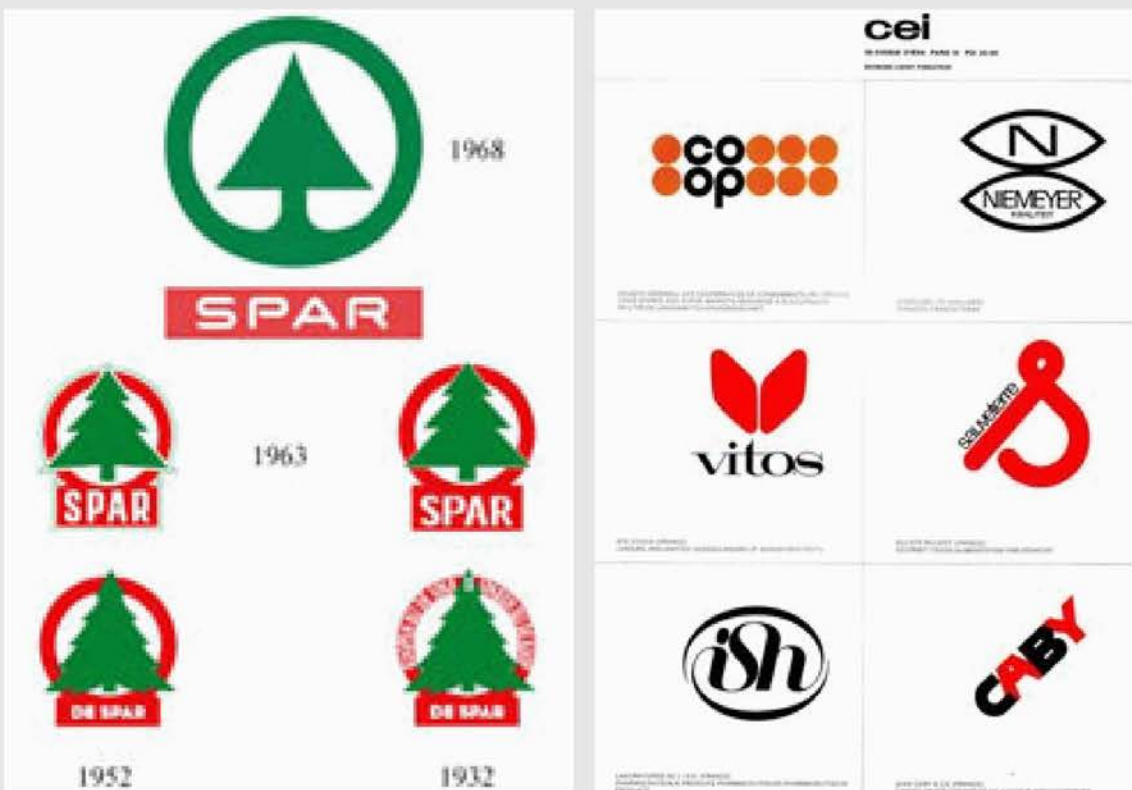





МОДА



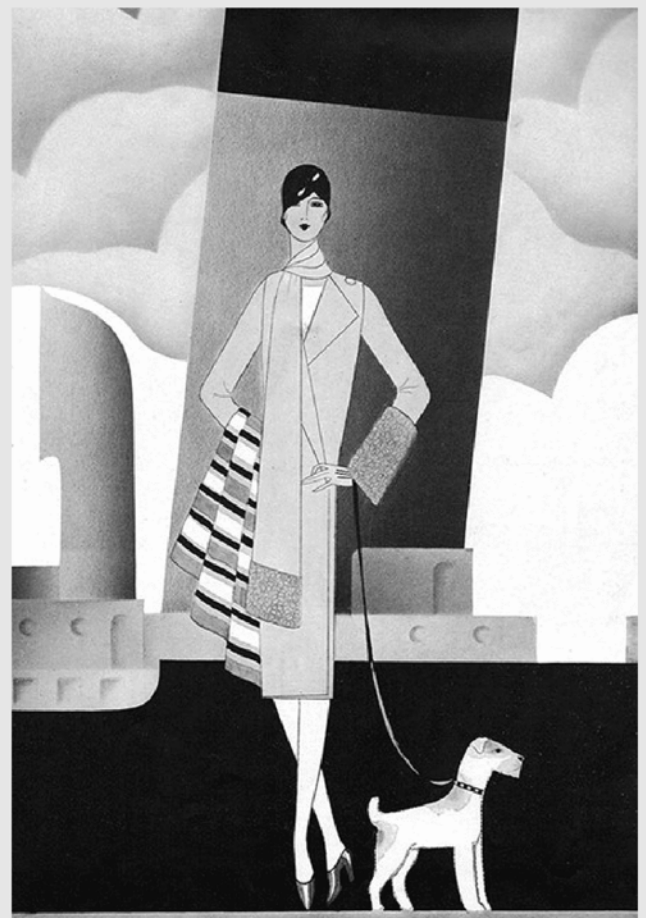



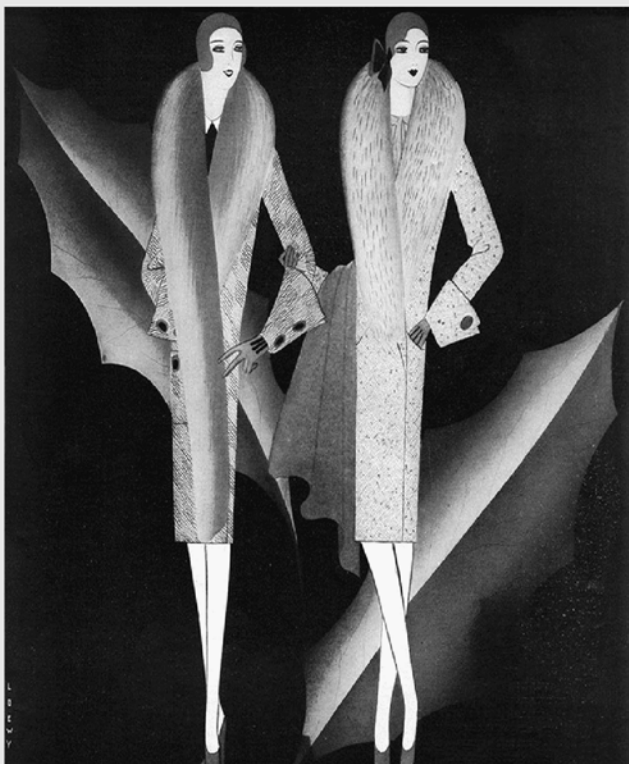



Schumacher's
 "Cosmopolitan" Line of Fabrics and Wallpapers
 created by
Raymond Loewy ASSOCIATES

"KEYED-OFF-KEY" ... a new dimension in design and color versatility!

A decorating delight! Original designs by incomparable Raymond Loewy, "Keyed-off-Key" ... to match, contrast or complement each other in pattern and color. The motifs are world-wide in inspiration, ideal for every decor whether simple or sophisticated. All in all, 6 print designs, 7 woven textures and 6 hand printed wallpapers.

Your choice of textures is unlimited ... from flimsy sheers of "man-made" fibers to luxurious imported Belgian linens. For breathtaking beauty and startling originality see Schumacher's "Cosmopolitan" line at your decorator and decorating departments of fine stores.

F. SCHUMACHER & CO., 60 W. 43rd St., New York 36, N. Y. • Fabrics • Carpets • Wallpapers • Woven Fabrics



ΚΟΚΑ ΚΟΛΑ



















Бутылка Фанты



СКАЙЛЭБ

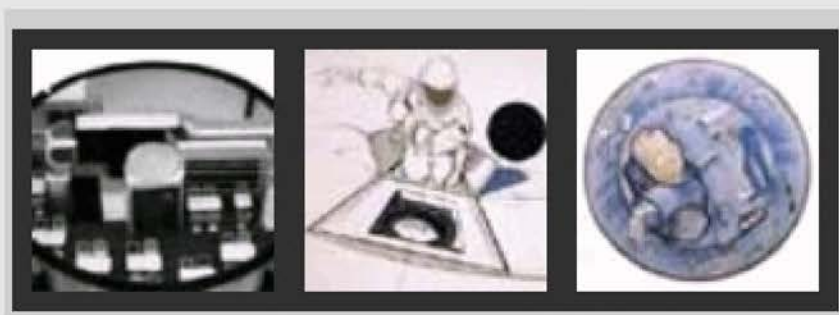

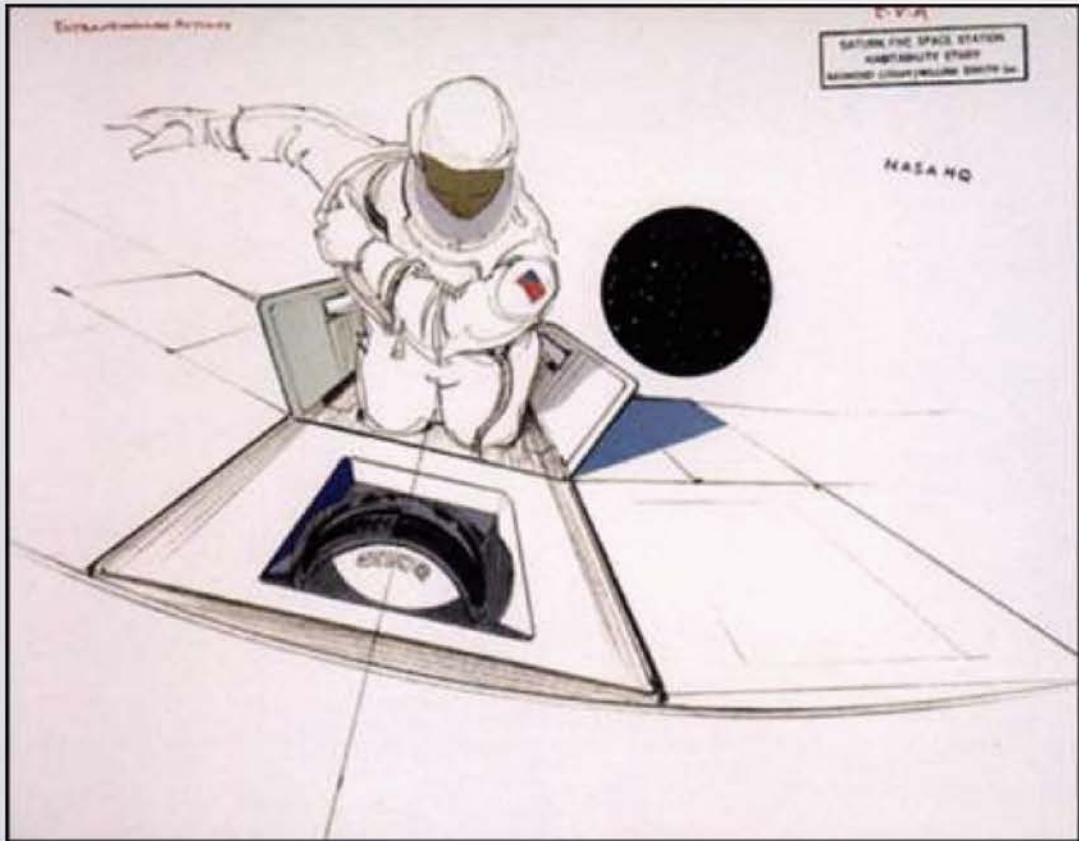
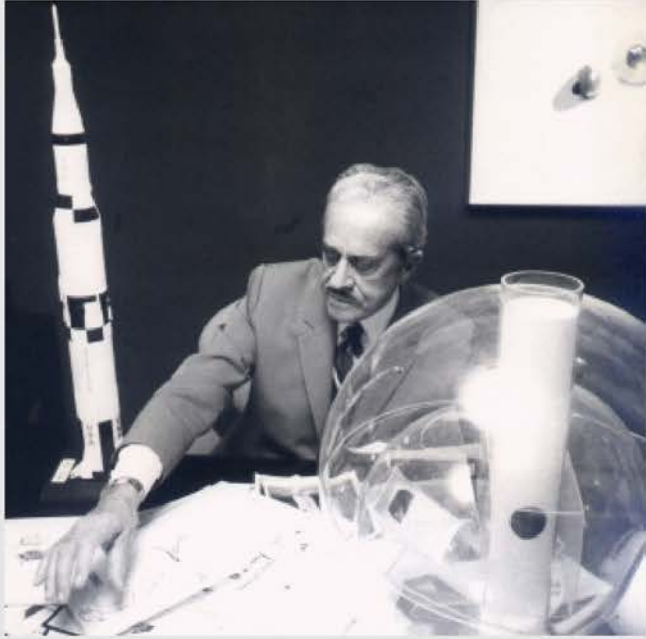

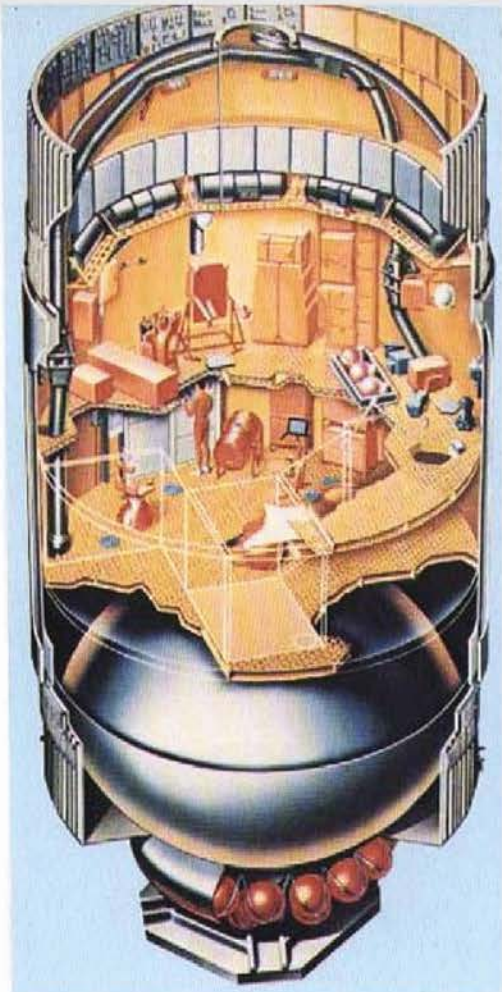
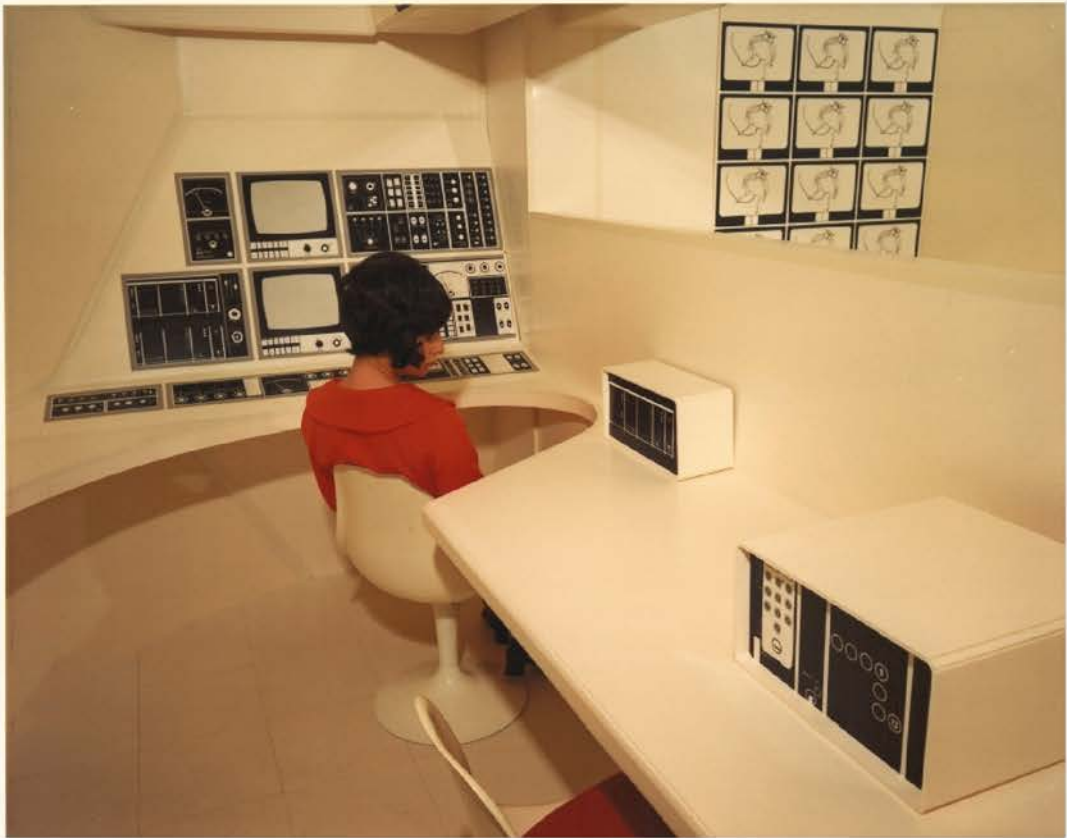

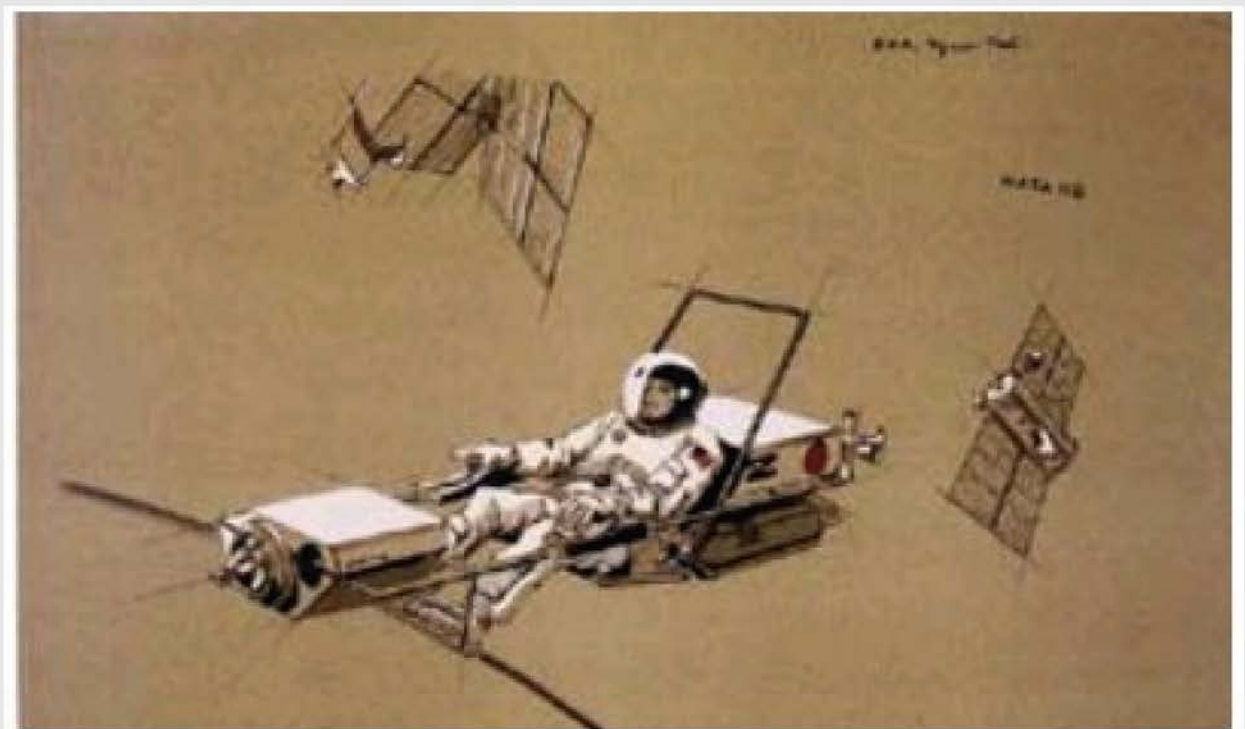
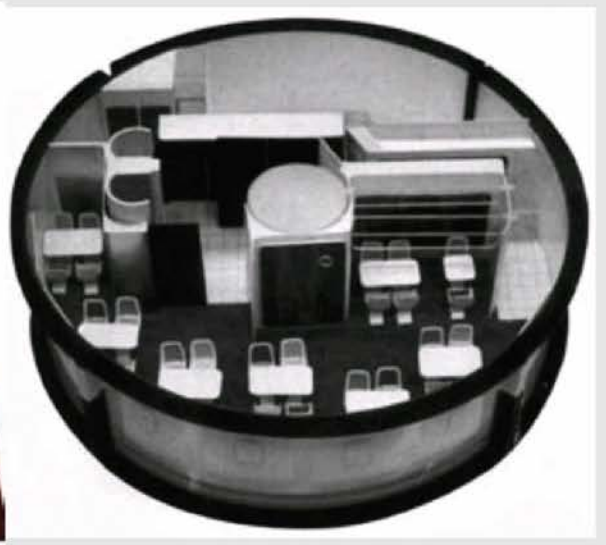
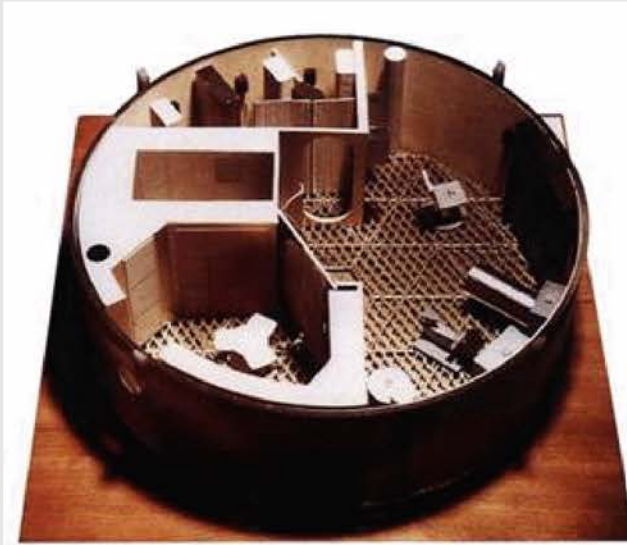

ФОТОАЛЬБОМ





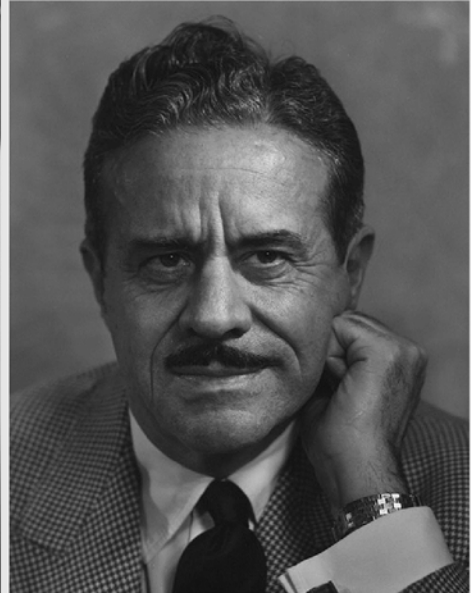

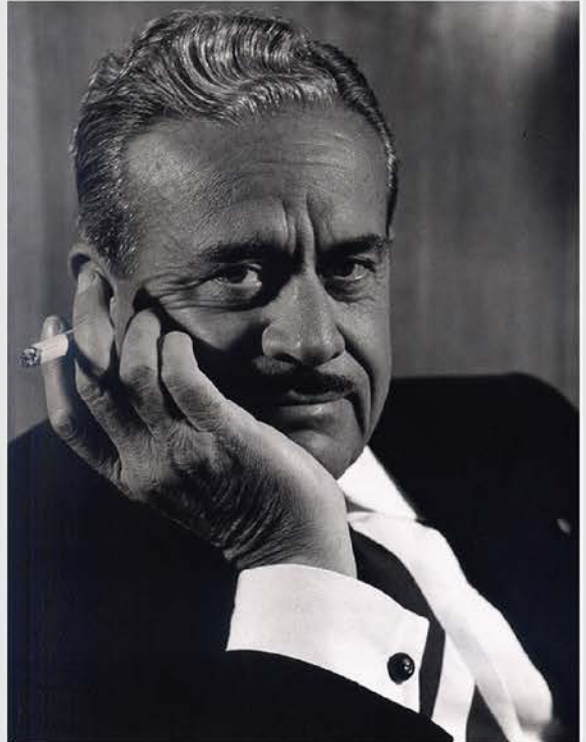

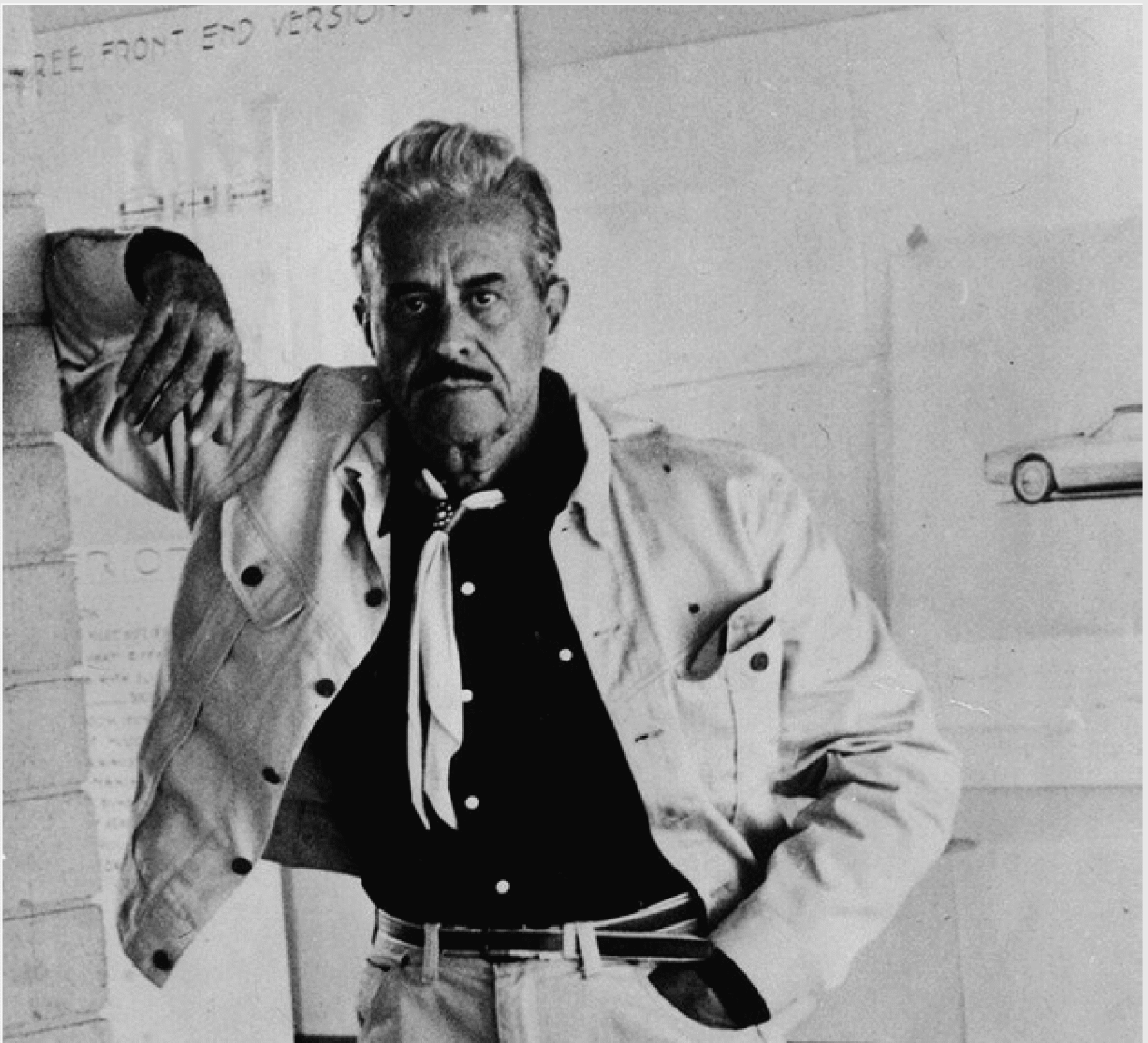
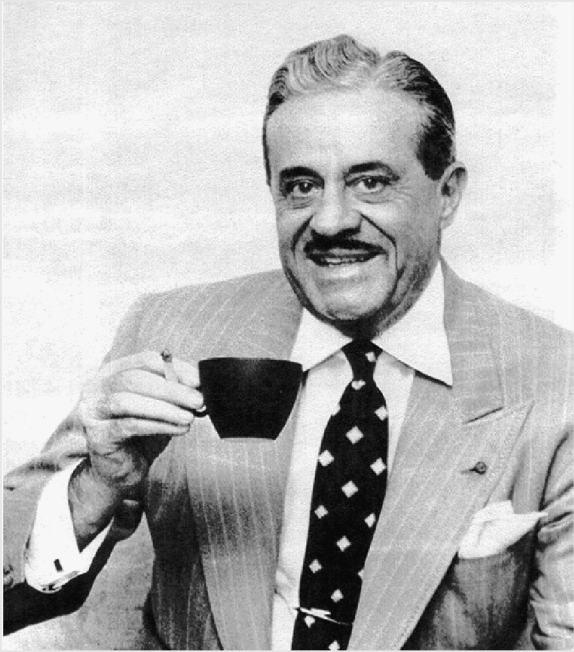

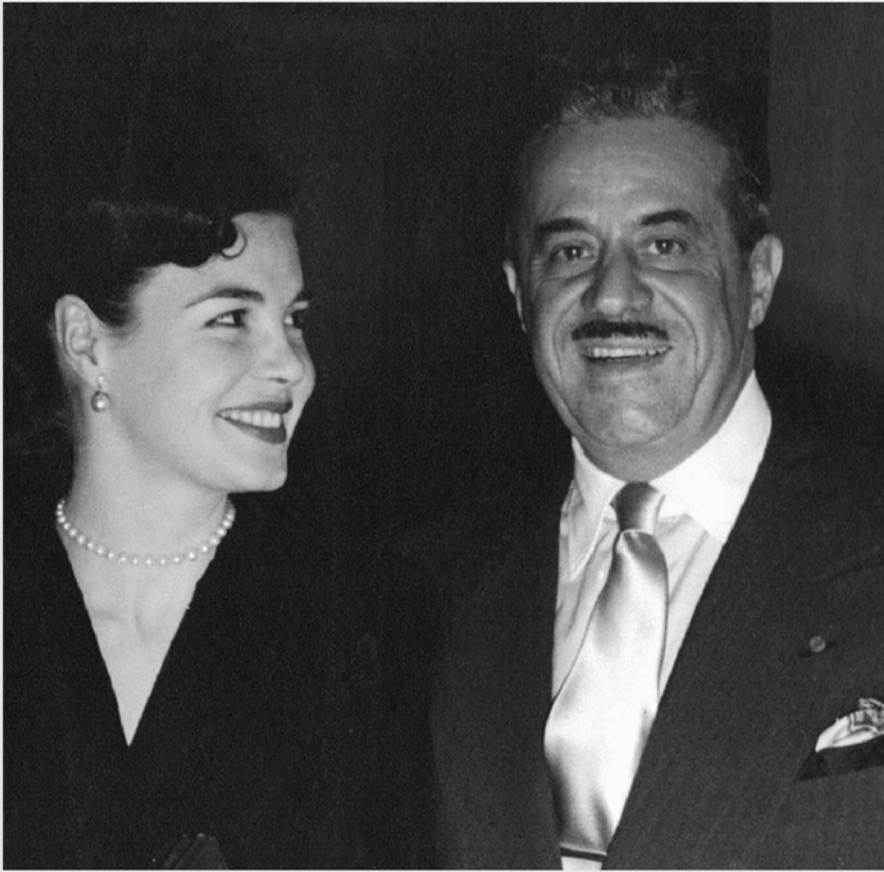

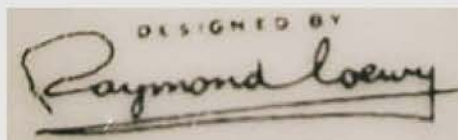

RAYMOND LOEWY

2 + 2 = 22

Loewy once characterized his style, force, and power with the words, "I always believed two and two made twenty-two." In one revealing sentence, he demonstrated his way of coming to a solution so unique that it went beyond the boundaries of even mathematics.

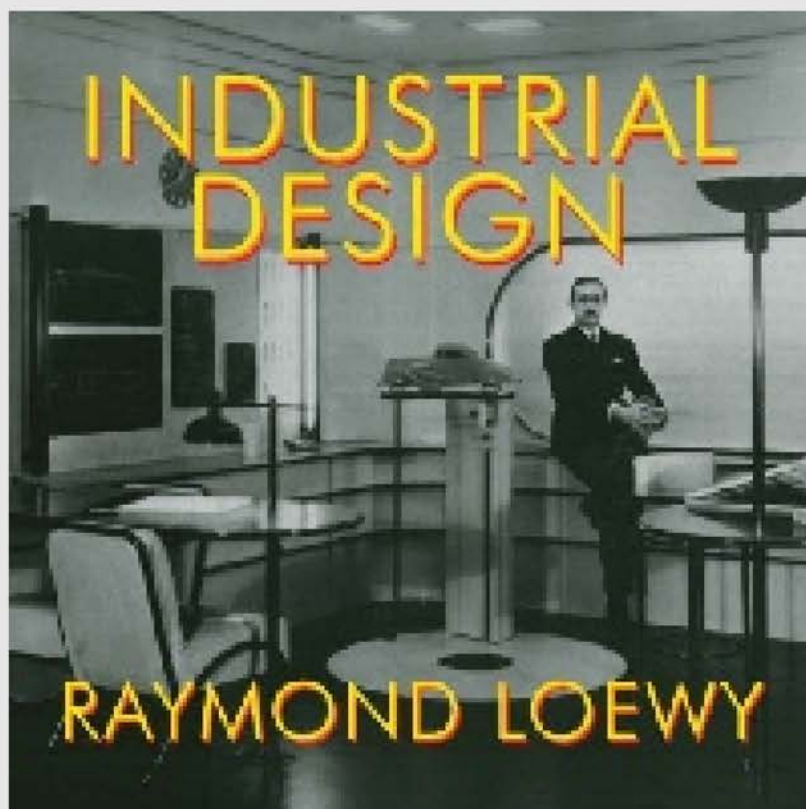

Н.Н. Александров

РАЙМОНД ЛОУИ

Альбом



2017

1320

Н.Н. Александров

ГЕНРИ ДРЕЙФУСС

Henry Dreyfuss



2017

ЖЕЛЕЗНАЯ ДОРОГА







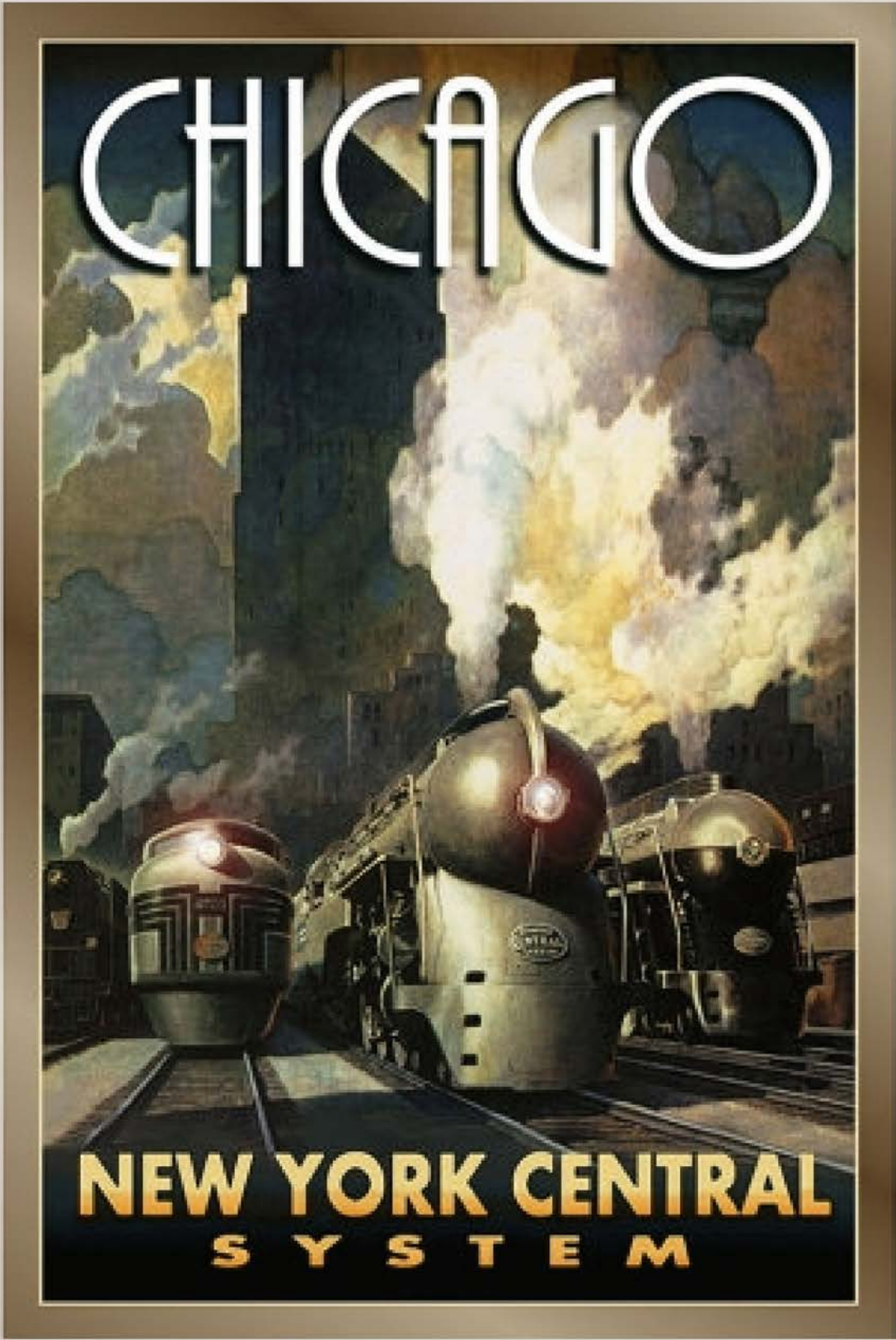



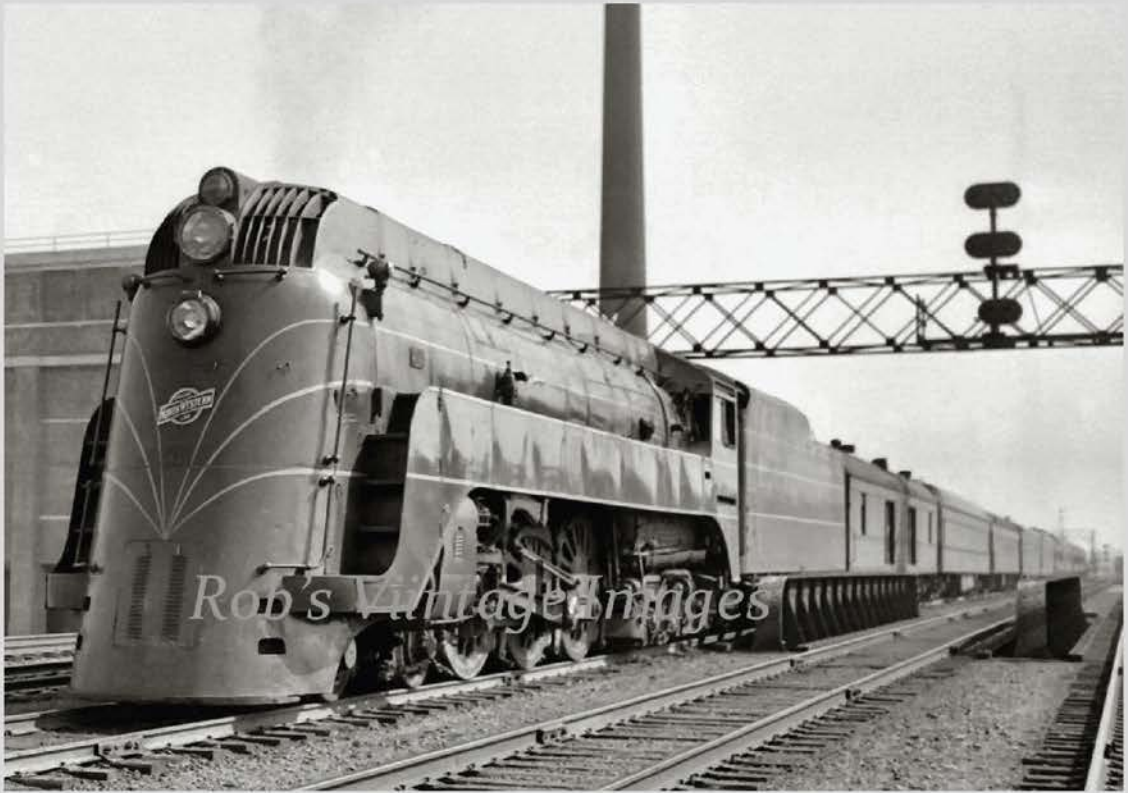

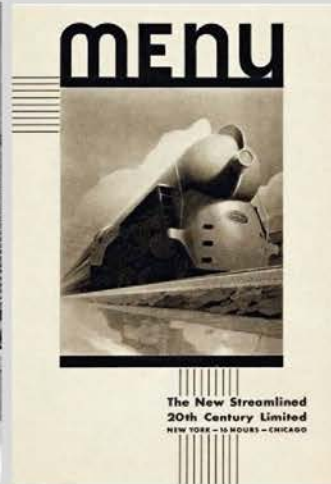

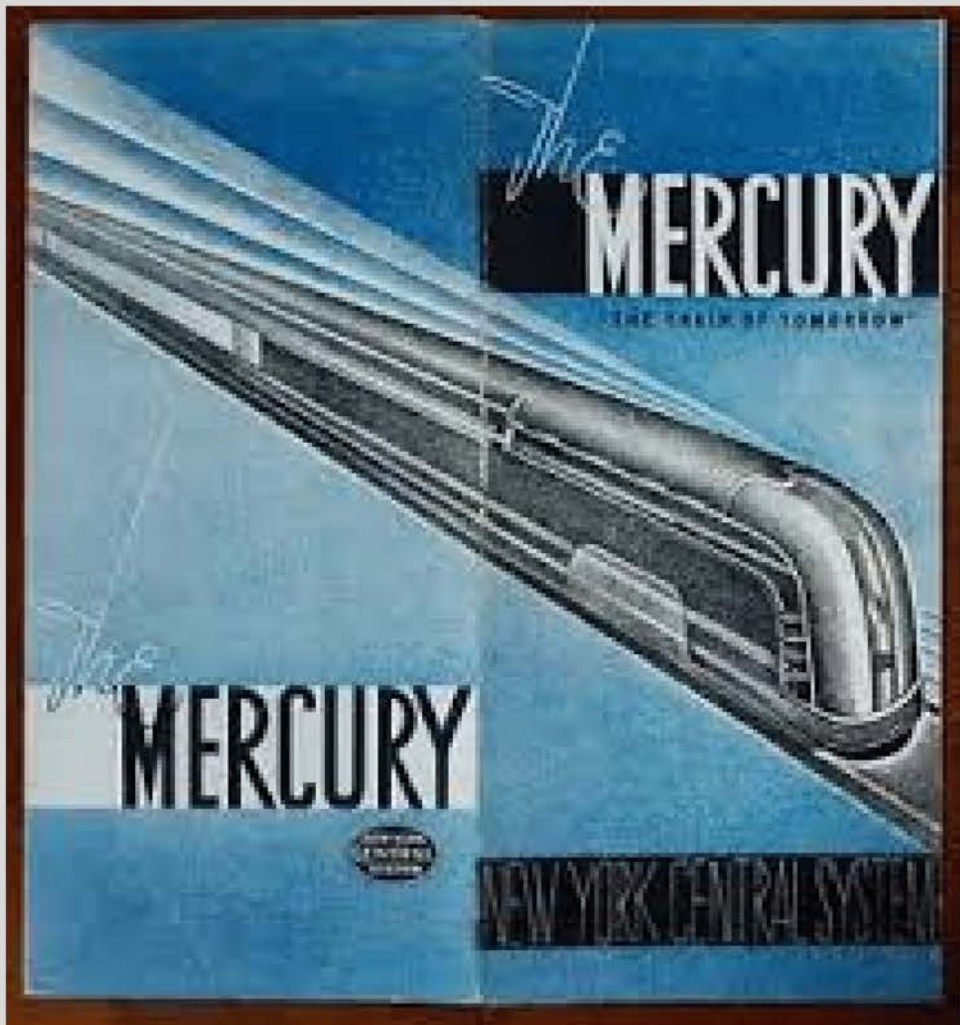

АВИАЦИЯ





Pilot and guests in this four seater plane feel "at home," as they do in a fine car. The instrument panel is simple and clear; and safety is designed into the operating

section by eliminating all protruding controls at critical areas. A station wagon interior, capable of carrying large loads, is also available.

For the Consolidated Vultee Aircraft Corp., Stinson Division . . . since 1943

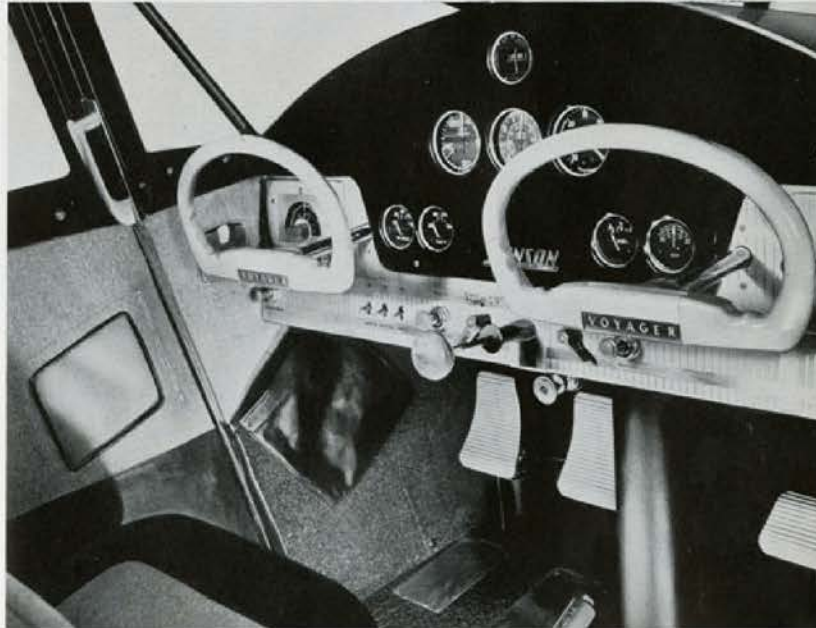

Specifications for Model VC-40: 1700 lbs. gross weight, 180 mph. speed at 10000 ft., 1000 ft. climb, 1000 ft. altitude.

An airline intended for long distance travel is a challenge to the designer. There are limitations in time, fuel, and space to work within rigid specifications of space and weight and time.

The main deck layout was a design considerably more modern than that of any other airplane of its class at a speed of over 100 miles an hour in long unobstructed flight.

On the lower deck, left hand are private restrooms and the main air conditioning unit. The main rest room is compact and fits neatly in any desirable position.

Not only rest and lavatories, but food service and convenience of passengers were actually built in a full size mock-up of this practical space solution.

As an "in-flight" business center, the passenger expects to come progressively closer to the level of comfort he enjoys in other forms of transportation.

For Consolidated Vultee Aircraft Corporation . . . since 1943



Upper Lounge Forward Washroom Middle Cabin



Starboard Lower Cabin





KLM's *Magnificent*

In this, the new version of the Lockheed Super Constellation, KLM has achieved a wonderful new way to travel. Never before has there been such a happy combination of speed and comfort. Four huge Wright Cyclone engines develop a mighty 12,000 H.P. to bring your destination 140 miles nearer every passing hour. And these hours, so few in number, will pass quickly too. Look at this amazing passenger view of your Royal Constellation's spacious interior. No one feeling pent aboard, but practically everything else for your comfort and enjoyment!

Royal **SUPER** *Constellation*





ADVENTURE IN CONTENTMENT

"A flight with TWA is something to look forward to... and something to remember. Despite the pressures of the times, you're greeted with courtesy, treated with hospitality, and flown with an expert skill that makes every flight an adventure in contentment."



DISCOVER A NEW FRONT IN AIR TRAVEL...



TWA'S great fleet of
SUPER-G CONSTELLATIONS

QUIETEST, MOST LUXURIOUS AIRLINERS IN THE SKIES TODAY



Created by Lockheed especially for TWA!
Powered by newest Turbo-compound engines!
Designed by Henry Dreyfus, world-famous designer!

See for yourself why experienced air travelers are saying TWA's new Super-G Constellations are the finest in the skies!

As you stroll through TWA's spacious cabins, you'll see the wide, roomy lounge chairs in any U.S. airline; floor-to-ceiling picture windows; rich wood-paneled interiors... much, much more. Strathairn leads you through every inch of these Constellations... and you'll see why TWA's Super-G Constellations are the finest in the skies!

Plus to enjoy this luxury in your next trip, fly TWA's Super-G Constellations... stay close to work... and meeting... between major U.S. cities. For reservations, see your TWA travel agent or call TWA, Trans World Airlines.

FLY THE FINEST... **FLY-TWA**
TRANS WORLD AIRLINES







ОКЕАНСКИЕ ЛАЙНЕРЫ

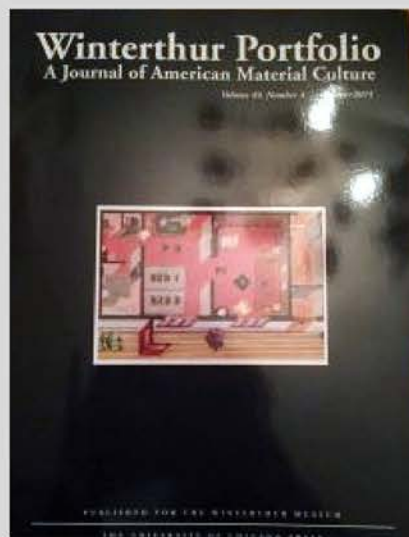



ТРАКТОРА



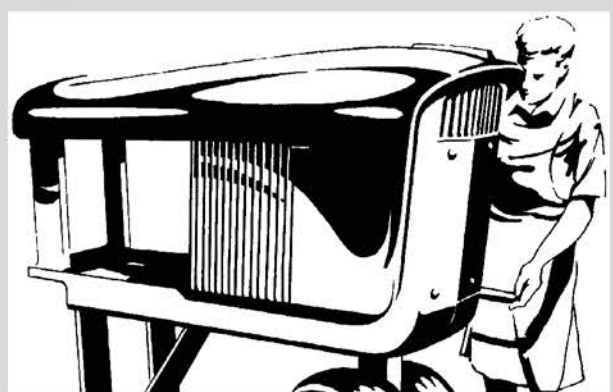
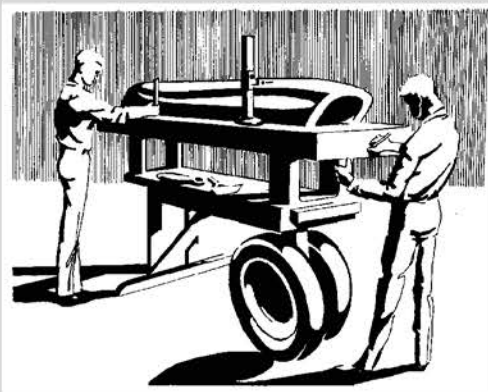
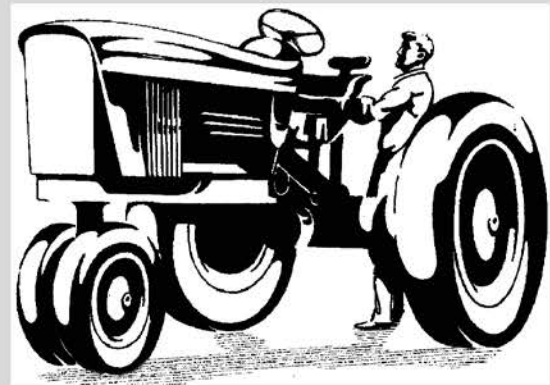
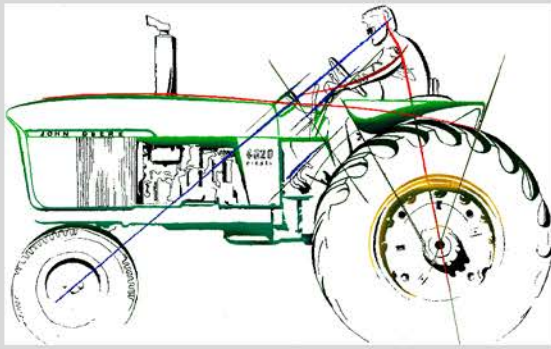

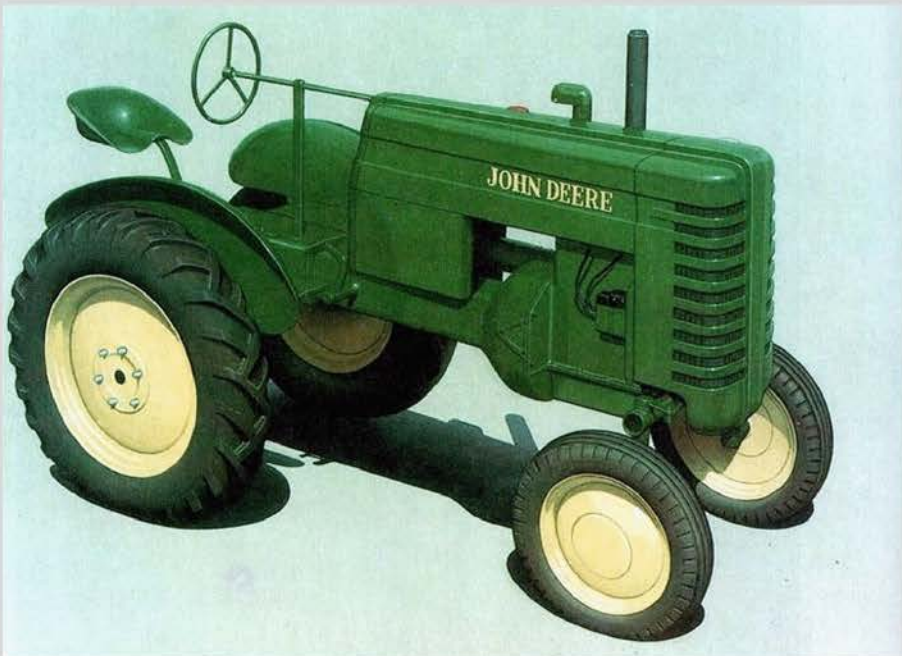

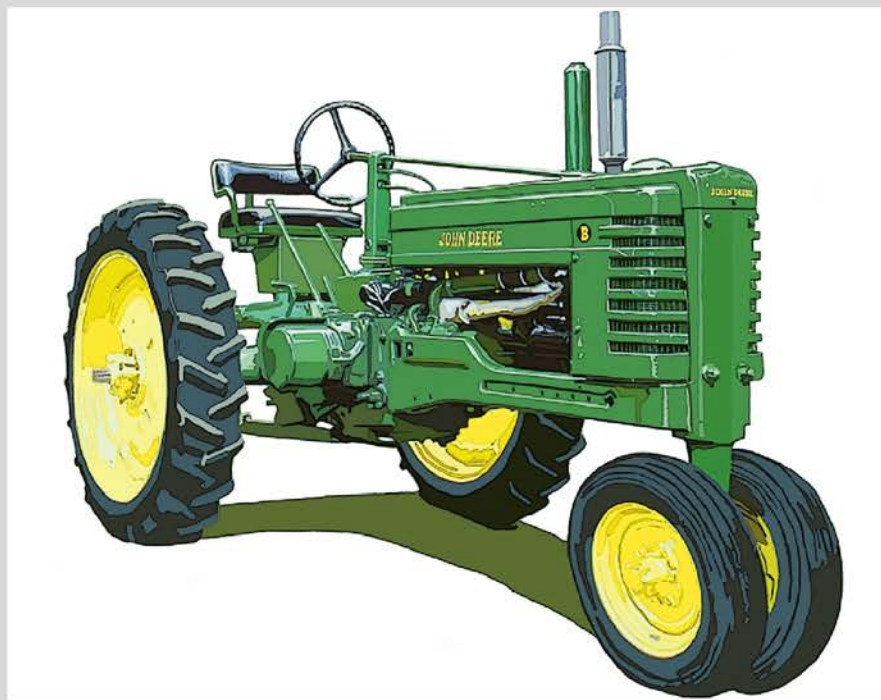









Джон-Дир-001



Джон-Дир-002



Джон-Дир-003



Джон-Дир-004



Джон-Дир-005



Джон-Дир-006



Джон-Дир-007



Джон-Дир-008



Джон-Дир-009



Джон-Дир-010



Джон-Дир-011



Джон-Дир-012



Джон-Дир-013



Джон-Дир-014



Джон-Дир-015

ТЕЛЕФОНЫ



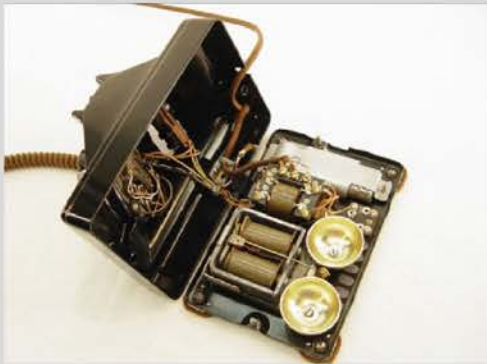



Service and Equipment Manual
Commercial Department
S.W. B. T. Co.

Part III, Section
Exhibit
11

telephones in **COLOR**

Plastic telephones to harmonize with home or office decorative schemes are available in the five colors illustrated below. Metallic telephones in color are available on special order. Dial finger wheels are transparent.



DARK GOLD
METALLIC



IVORY
PLASTIC



STATUARY BRONZE
METALLIC



PEKIN RED
PLASTIC



GRAY GREEN
PLASTIC



OLD BRASS
METALLIC



DARK BLUE
PLASTIC



OLD ROSE
PLASTIC



OXIDIZED SILVER
METALLIC







America has fallen in love with the
new Princess phone

In white, beige, pink, blue and turquoise—attractively priced

it's little!... it's lovely!... it lights!



Small size is one reason why the Princess is so popular. It fits where you didn't have room for an extension before—on table, desk or kitchen counter.



Graceful styling lets you put the Princess anywhere in your home and be sure that its lovely lines and the color you choose will blend in beautifully.



Lighted dial glows in the dark, brightens for easy dialing when you lift the receiver. Order from our Business Office or ask your telephone man.

BELL TELEPHONE SYSTEM 



Fashion, Bill Bliss... 'Trimline' phone, your Bell Telephone business office.



 **AT&T**

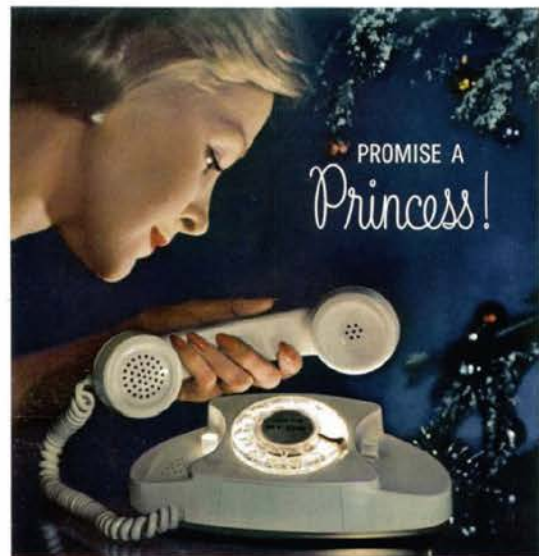

PROMISE A
Princess!

*Let this lovely little phone
light up the season for someone you love!*

Promise a Princess phone to someone you treasure. She'll welcome the convenience of an extension phone, and the added compliment of good taste.

The small size of the Princess saves space wherever it's put—on table or desk or kitchen counter. And its modern styling lets it go anywhere in the home, and go beautifully.

What's more, the dial glows softly in the dark and lights brightly when you lift the

receiver, for easy dialing. So light up the holiday season by ordering a Princess phone for someone special. You can include prepaid service for any period of time you wish.

It's easy to let the person you please choose the color, too—white, beige, pink, blue or turquoise. Just call or visit your Bell Telephone business office, or ask your telephone man.

BELL TELEPHONE SYSTEM 



1965 **TRIMLINE®** This instrument is directed toward the "dial-to-user" concept and is designed as a small combined telephone set with a space-saving rotary dial. It includes a dial light. Service on a national basis followed trial use of different designs produced by Western Electric's model shop in Indianapolis, where the telephone is made.



ПИШУЩИЕ МАШИНКИ





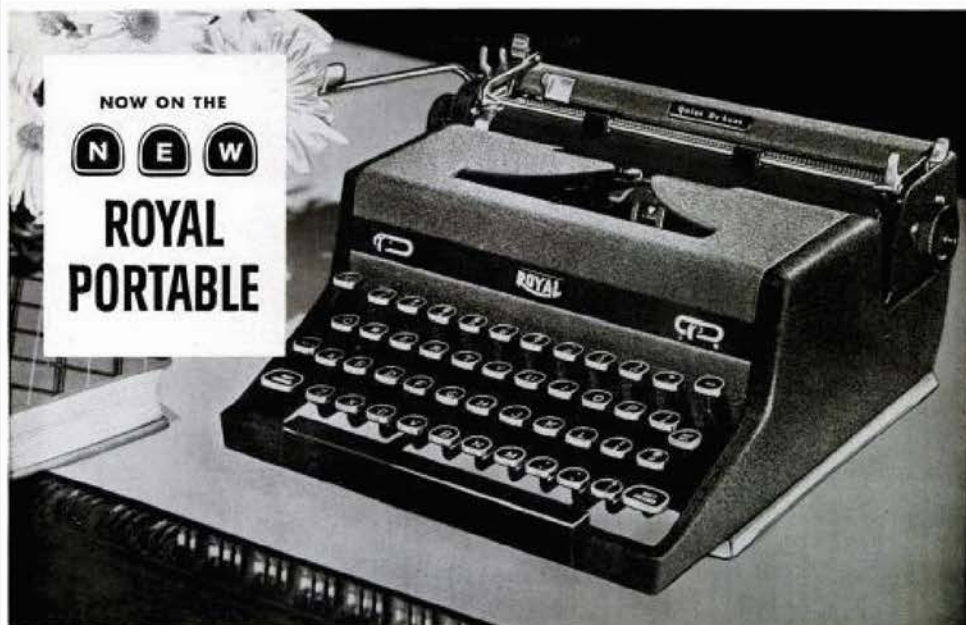

FINGER FORM KEYS...

designed to cradle your finger tips!

The New Royal Portable introduces the most dramatic typewriter improvement in years . . .

FINGER FORM KEYS! Imagine a typewriter key which follows the very contour of your own finger! Specifically designed to *cradle* your finger tips when they strike the keys!

This remarkable Royal improvement brings a new comfort, a new ease of operation, a new speed to typing!

And the New Royal Portable—the most mod-

ern typewriter ever designed—brings you so much more besides!

BEAUTY! Not merely beauty to look at and admire, but beauty put to work—beauty that makes typing easier and faster!

Henry Dreyfuss, famous designer, incorporated his world-renowned styling into the New Royal Portable to help make it the *World's First Truly Modern Portable Typewriter!*

Many More Improvements!

SPEED SPACER: A space bar built right into the framework of the typewriter! Only the New Royal Portable has it! With **SPEED SPACER**, there's nothing to impede spacing action . . . nothing to hurdle when using the space bar!

RAPID RIBBON CHANGER! Only Royal gives you this dramatic improvement which takes the fuss and mess out of installing a new ribbon!

"MAGIC" MARGIN! Only Royal gives you a margin-setting device which makes all other portable margin setting obsolete! Just position the carriage, flick your finger, and "Magic" Margin does the rest!

Literally, there are *dozens* of other features which make this Royal—more than ever—the World's No. 1 Portable! See the New Royal Portable at your dealer's. See the Portable so easy to look at . . . so easy to operate, that all others seem old-fashioned! Two models: The new Quiet De Luxe; The new Arrow.



THE NEW ROYAL PORTABLE

The World's First Truly Modern Portable Typewriter

"Magic" is a registered trademark of Royal Typewriter Company, Inc.

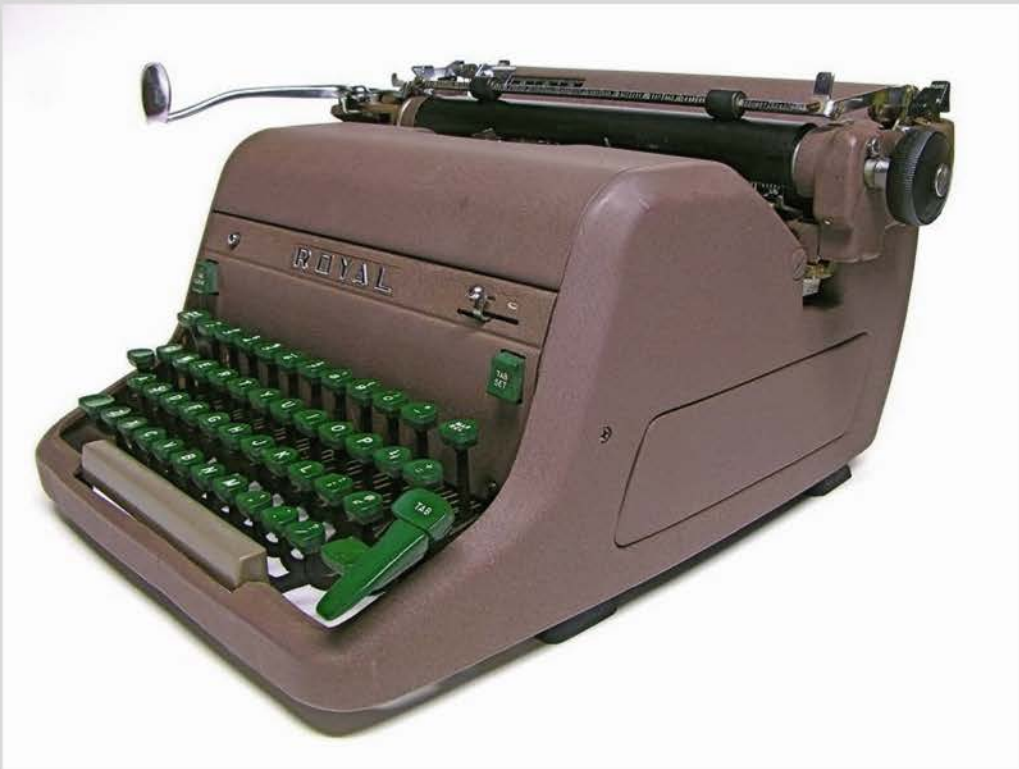

ПЫЛЕСОСЫ

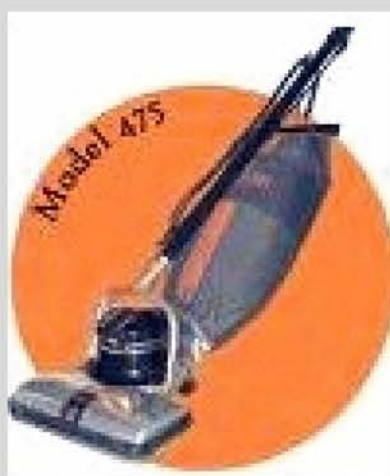





Hoover Convertible

with the *Automatic Shift*
and the
fastest pickup in cleaning!



It Beats...as it Sweeps...as it Cleans





ΦΟΤΟΑΠΠΑΡΑΤΥ









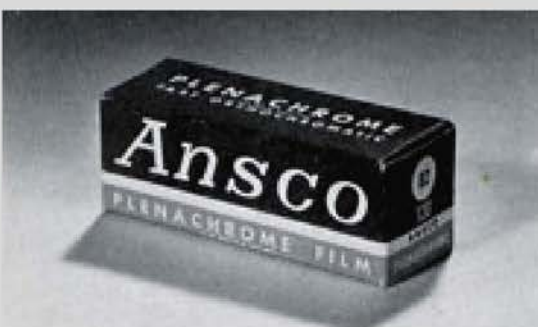
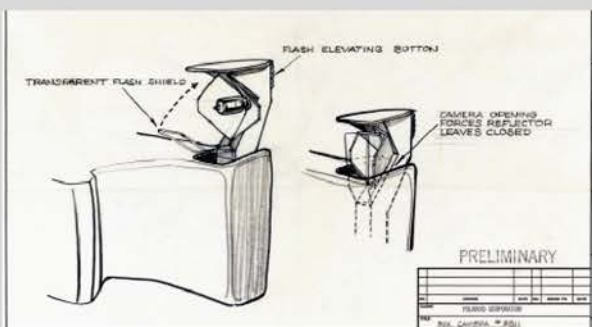
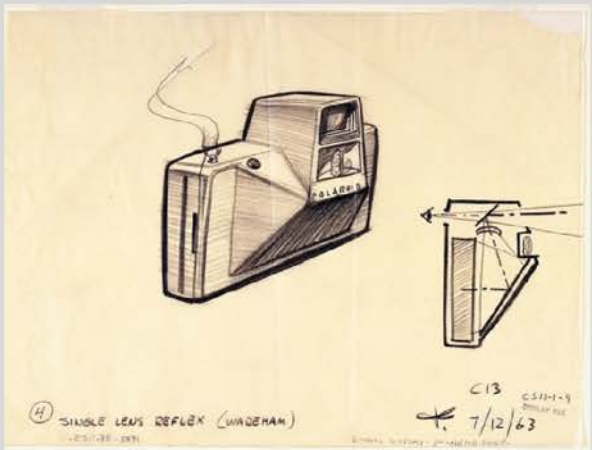
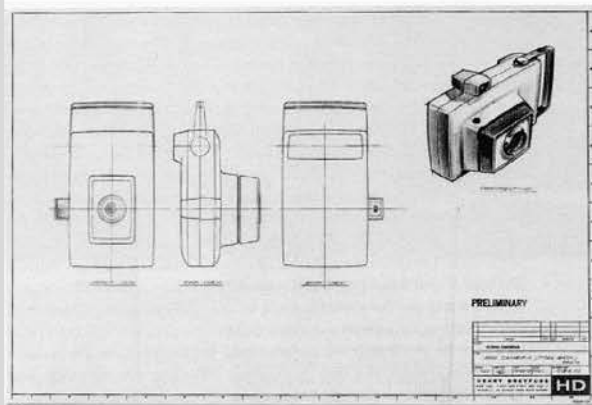
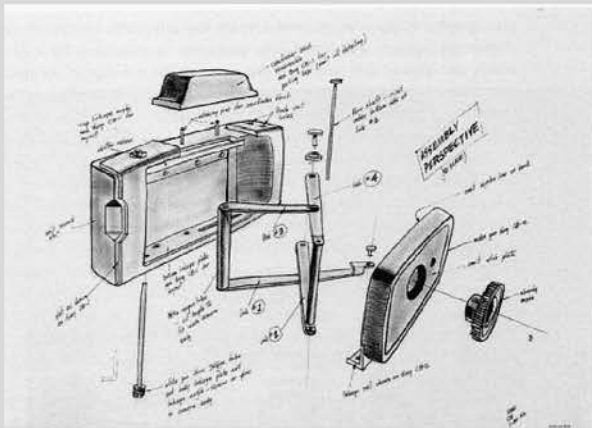

СТИРАЛЬНЫЕ МАШИНЫ

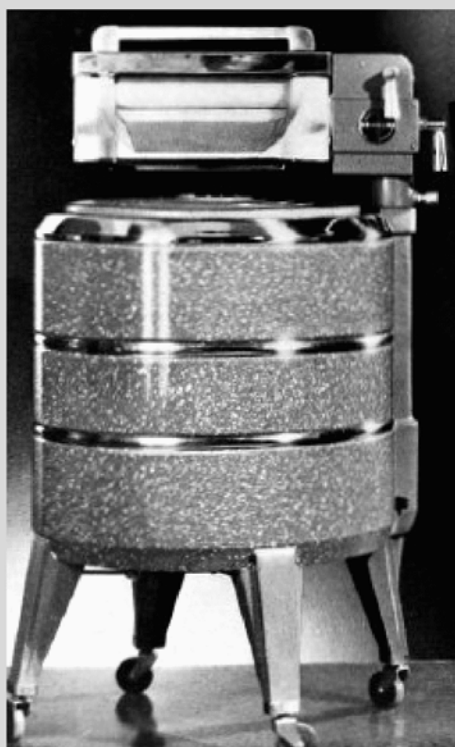





ХОЛОДИЛЬНИК

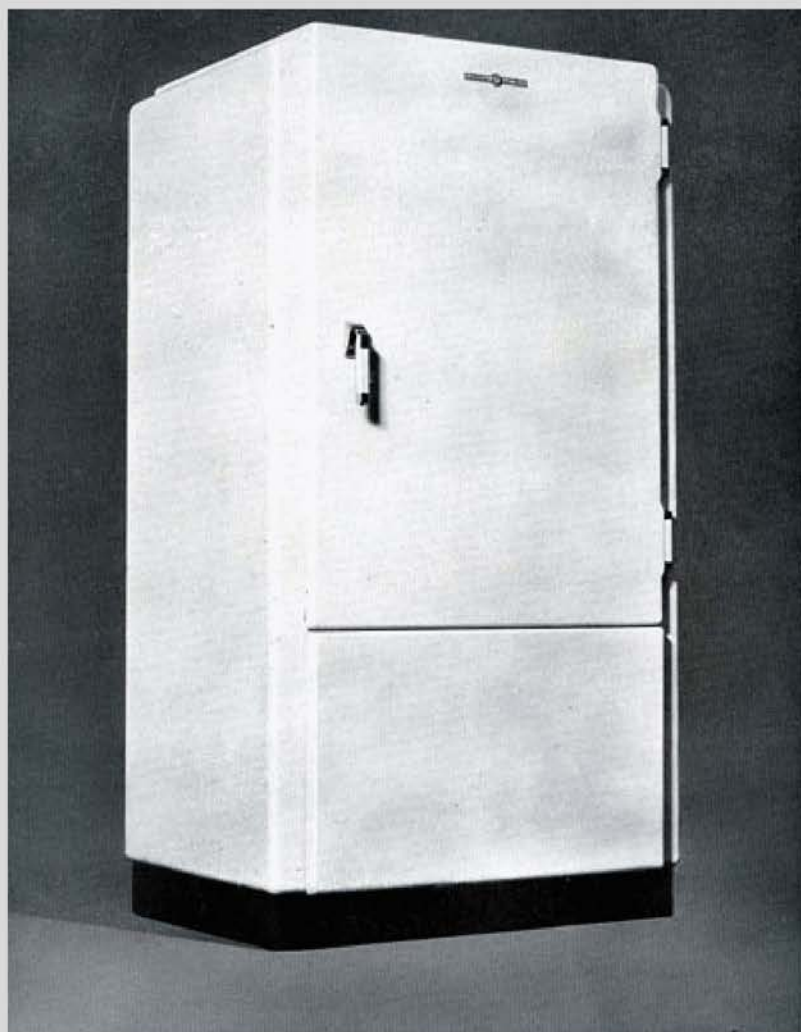

УТЮГИ







РАДИО, ТВ





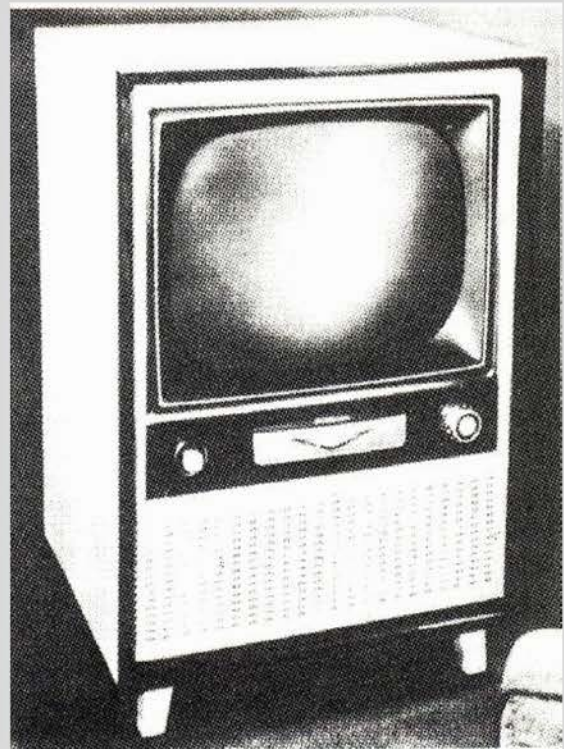

ТОСТЕР



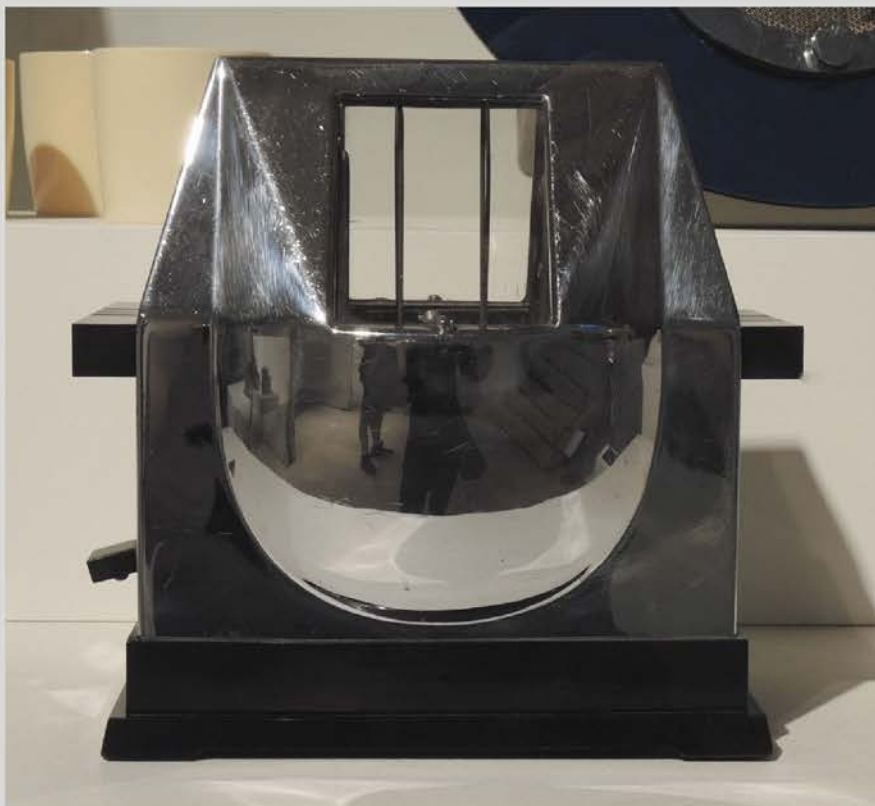

РУЧКА ПЕРЬЕВАЯ







*Burgundy
Skylines*



АРХИТЕКТУРНЫЕ ФОРМЫ









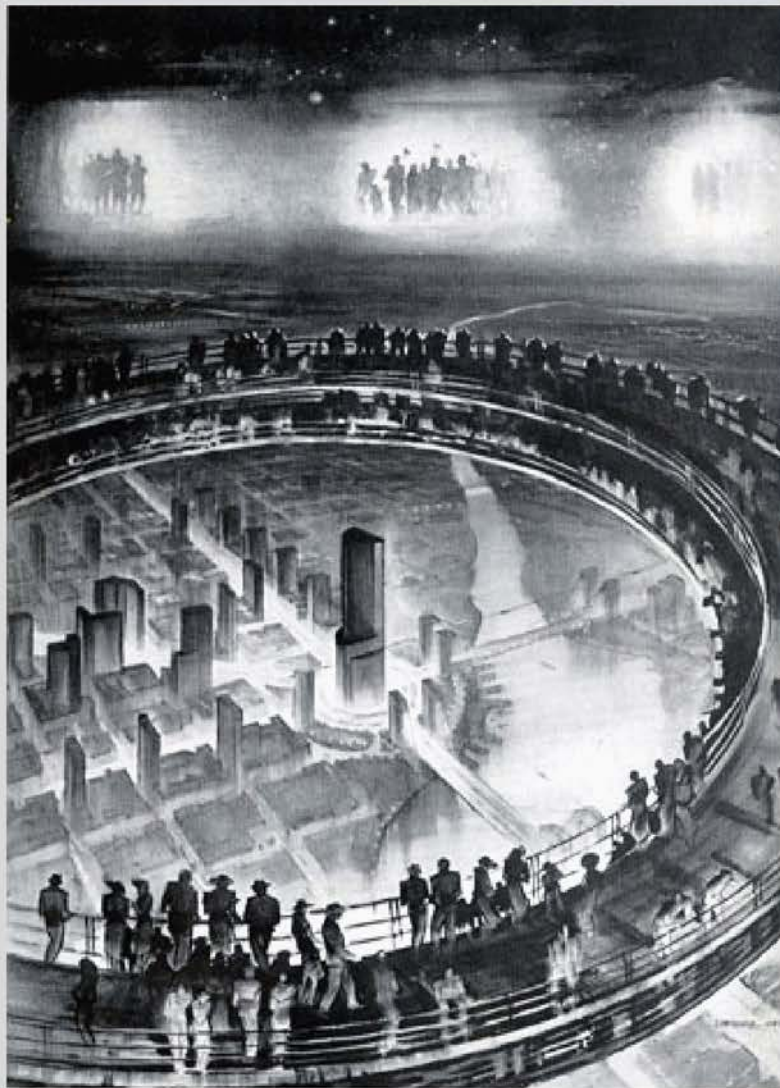
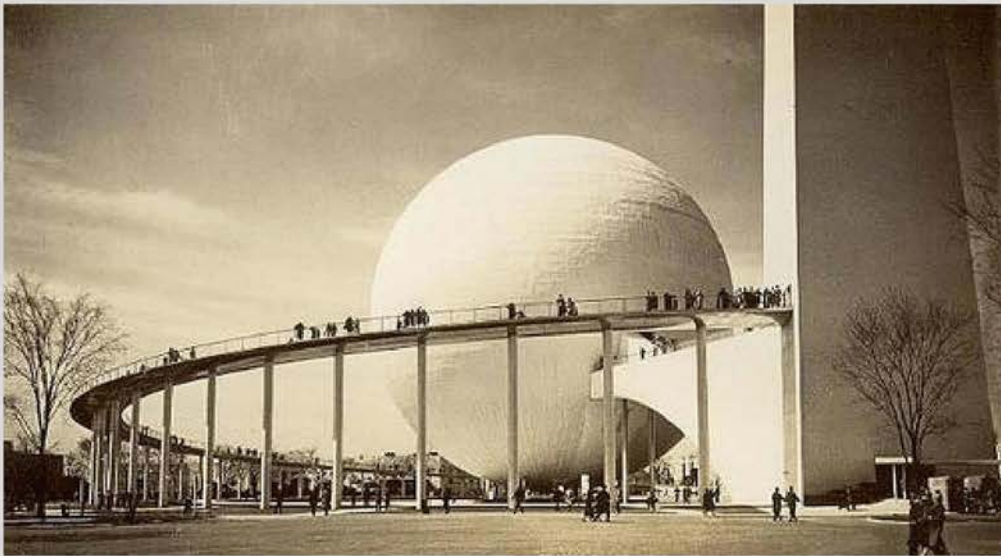

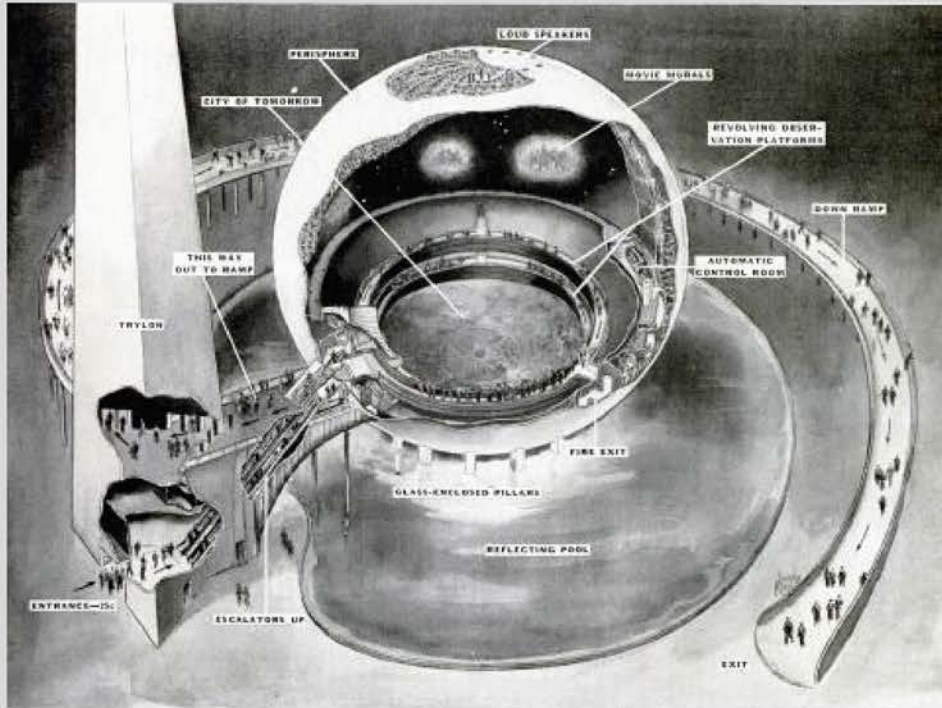

The City of Tomorrow will look like this scale model to a spectator on the Periphery platform. It is shaped like a basketball park. Back of same plate is the airport with straight

Night in the Periphery is shown in the artist's conception on the opposite page. The spectator has watched day fade away in the City of Tomorrow. Lights come on in the buildings. Stars twinkle above. The music swells and out from between stars and moving disks march the figures of hundreds of men and women, projected on the dome. They grow larger and larger until, at the end, they encircle the globe in a living mural 18 ft. high.



The central freight terminal faces a modern harbor. Mechanical carriers take cargoes from ships to warehouses right in back of the docks. Back of warehouses is the business district.

hangar. Just in front is the steamship terminal. Rail and bus passages also arrive here. Behind pitcher's box is Civic Center. Super-speed highways wind through green-belt areas.



The Sports Center has small outdoor wading pool, a large outdoor pool and, back of grandstand, a huge indoor natatorium whose "orange-peel" doors can swing open to let in fresh air.



The shopping center, right back of Civic Center, is made up of units like this: a big store from which paths criss cross to smaller shops. Shoppers motor in and park under the lawn.

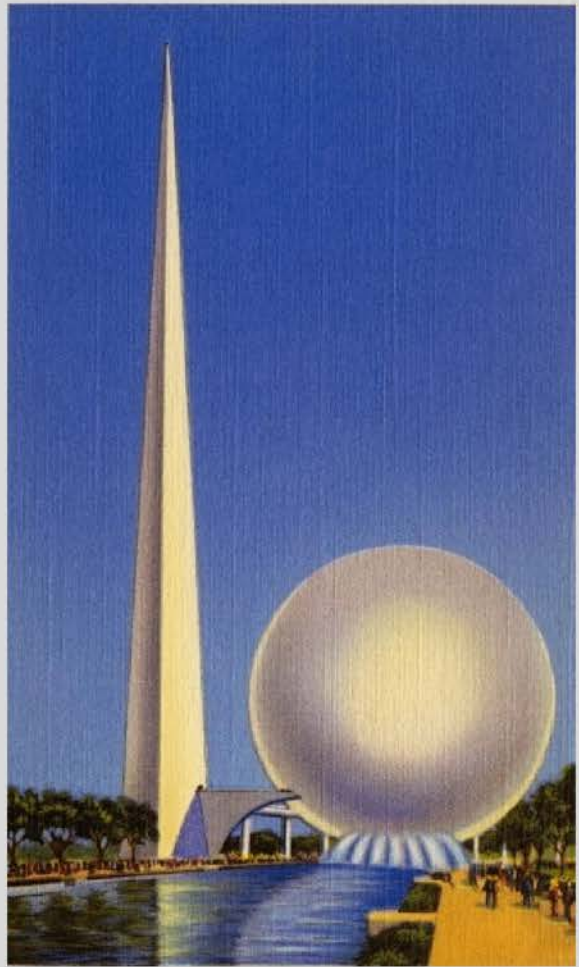

ИНТЕРЬЕР



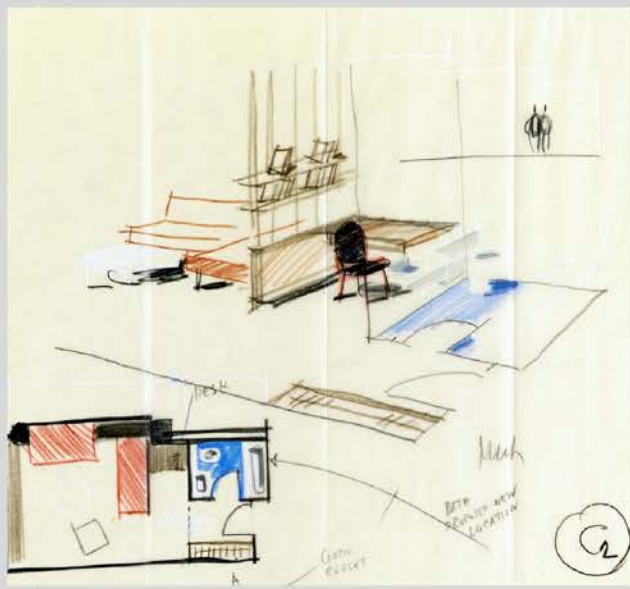
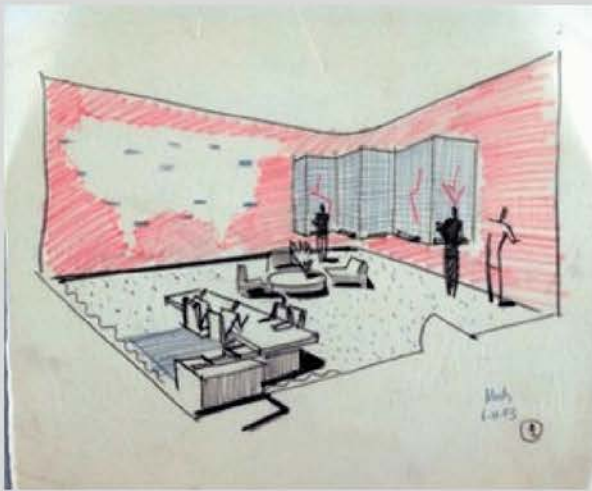
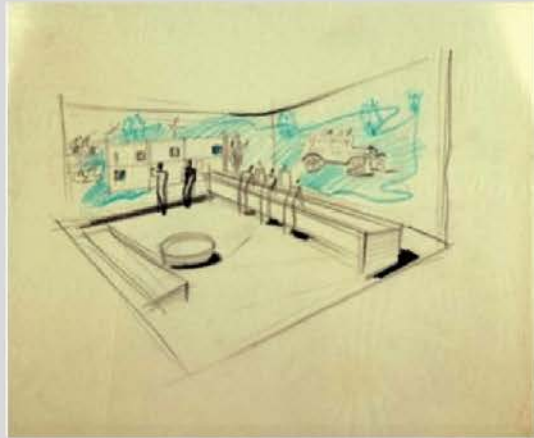



The small picture shows an hotel room. Inexpensive, but overcrowded. Now dresser, desk, radio, bedside table, and closet are combined. Wallpaper, moulding, lighting, all added to the effect of size. Five hundred of these rooms have been made. For Hotels Shaffer Company, Inc.



Below this main display is a display of the new type of get administrative and show maps. Since they are made in a special way they are not only of great practical importance. ... For the Shaffer Company, Inc. ... The whole room is a masterpiece of modern design. ... The main display of the map is a masterpiece of modern design. For the Shaffer Company, Inc.



Provide a particular problem with the first world. ... For the Western Union Telegraph Co.



The whole picture is a masterpiece of modern design.

МЕБЕЛЬ И ОБОРУДОВАНИЕ





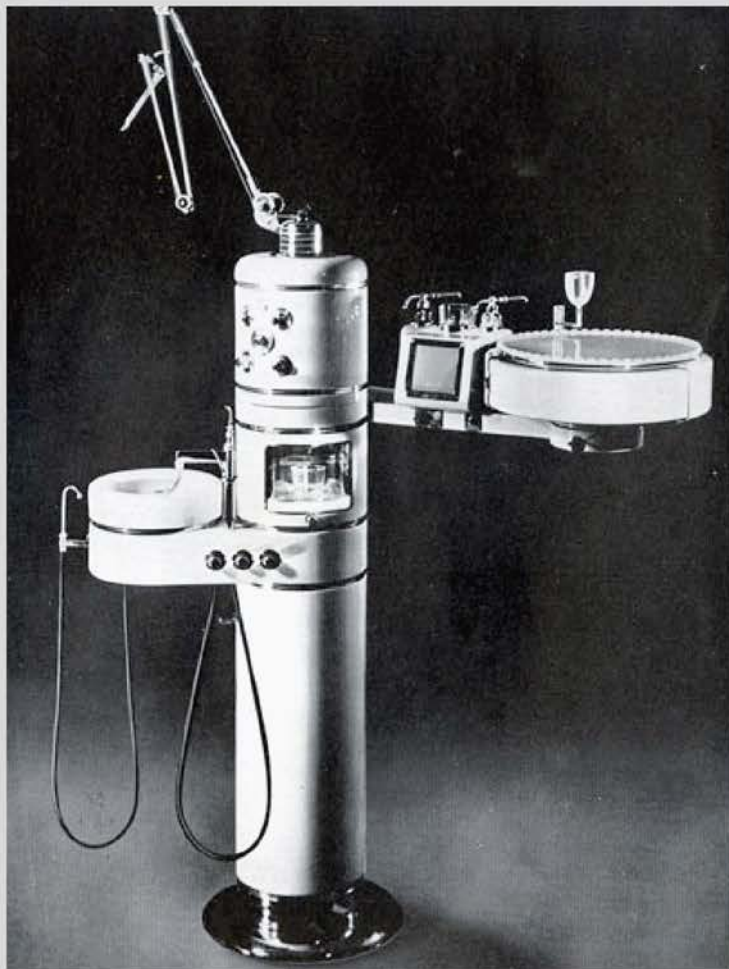



САНТЕХНИКА









ЧАСЫ И ТАЙМЕРЫ









ПРИБОРЫ И СВЕТИЛЬНИКИ



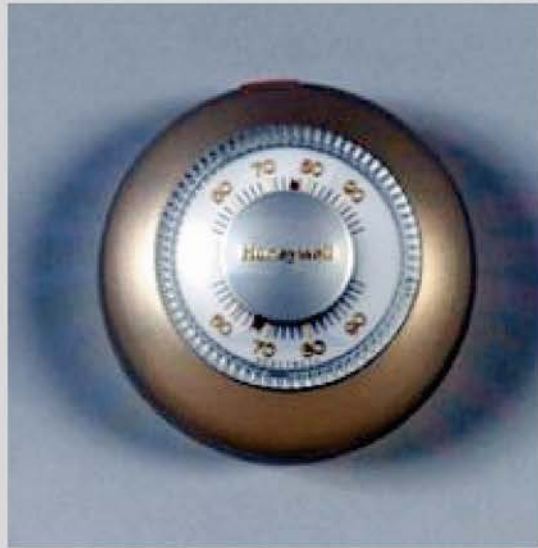



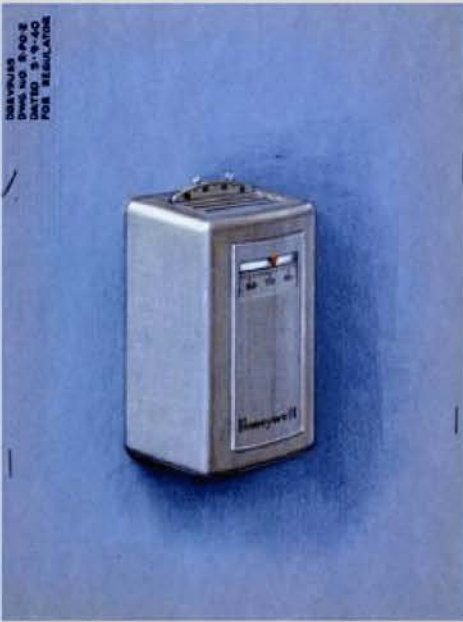

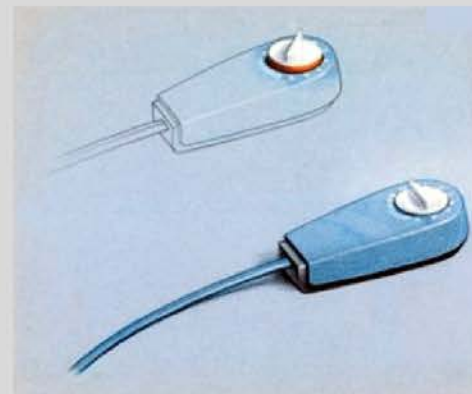

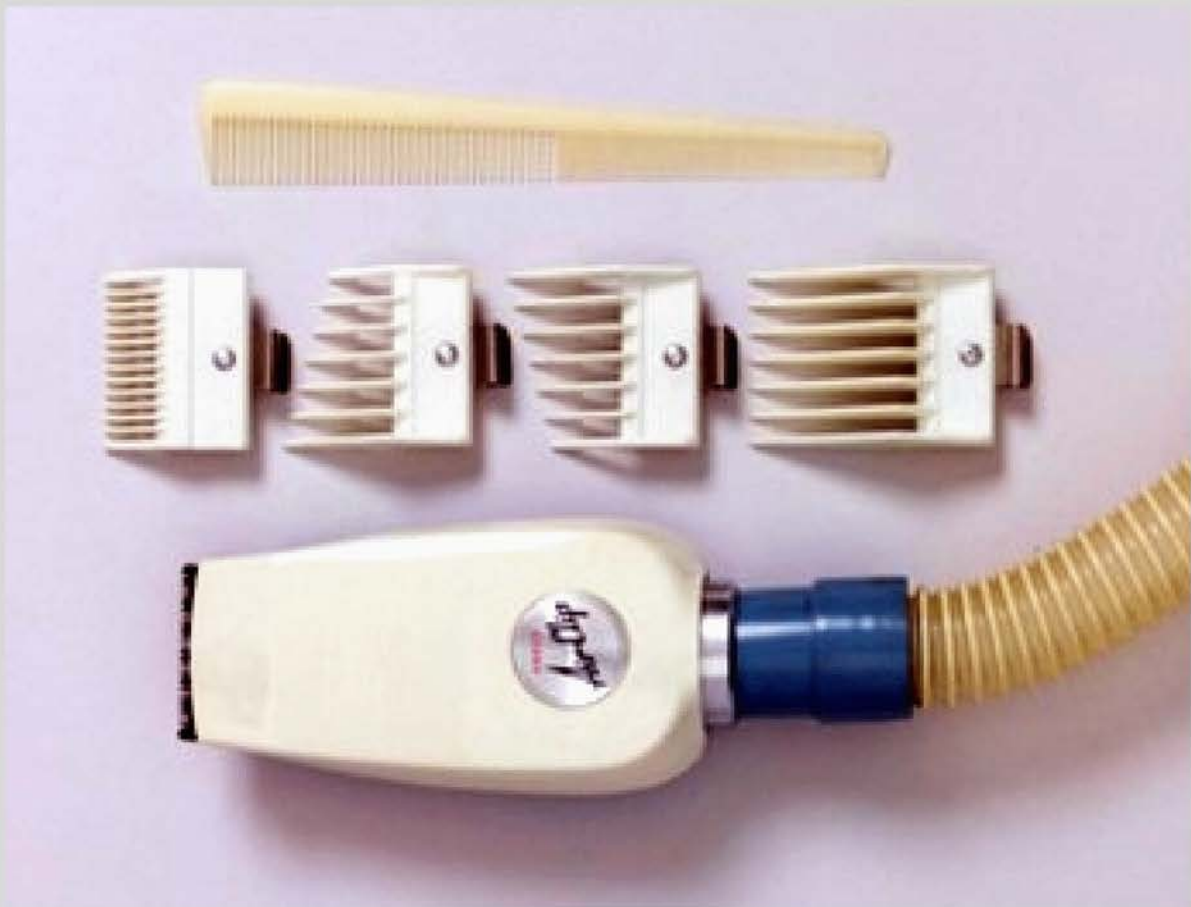

ПОСУДА







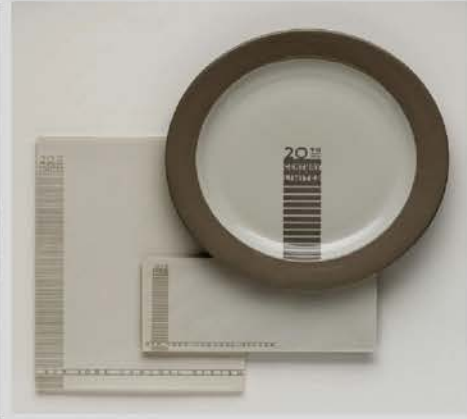



ΠΡΟΧΕΕ

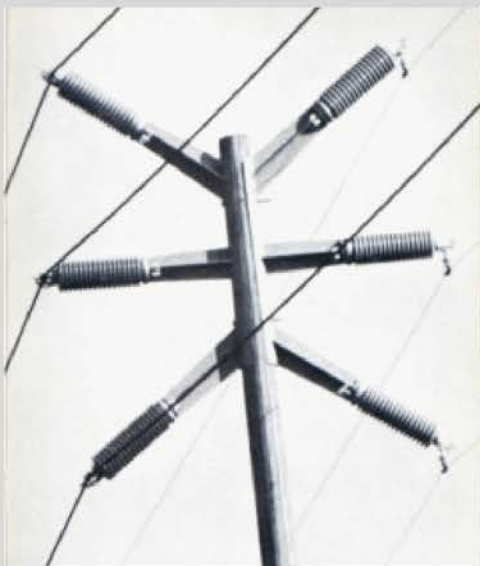









Notes along the Trail
of the
OLYMPIAN
Hiawatha
*
THE COLUMBIAN



арифмометр



телетайп

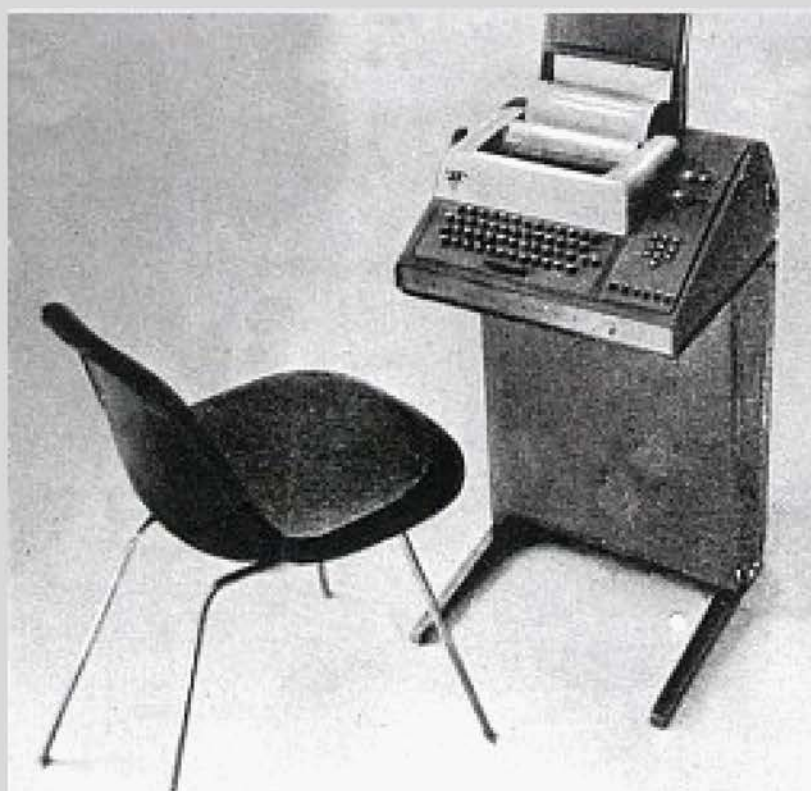

ЭРГОНОМИКА

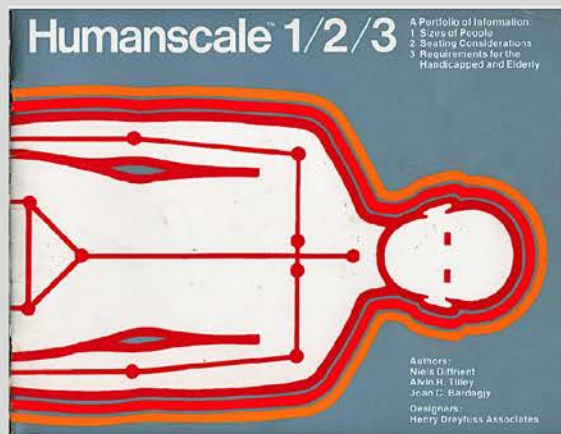

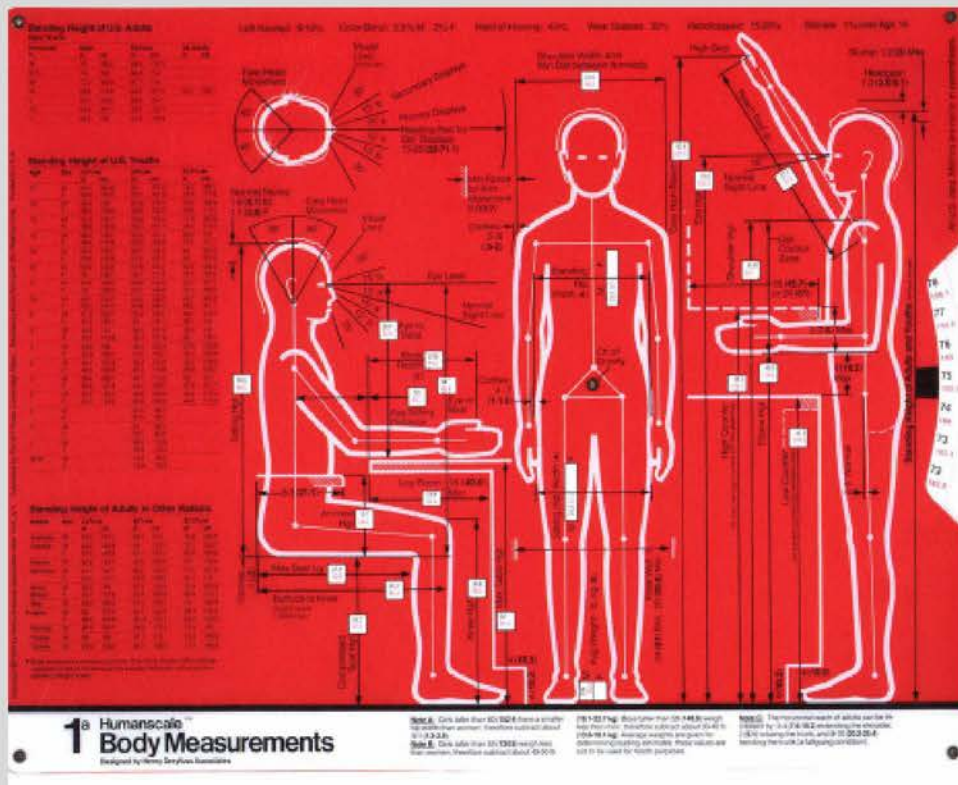
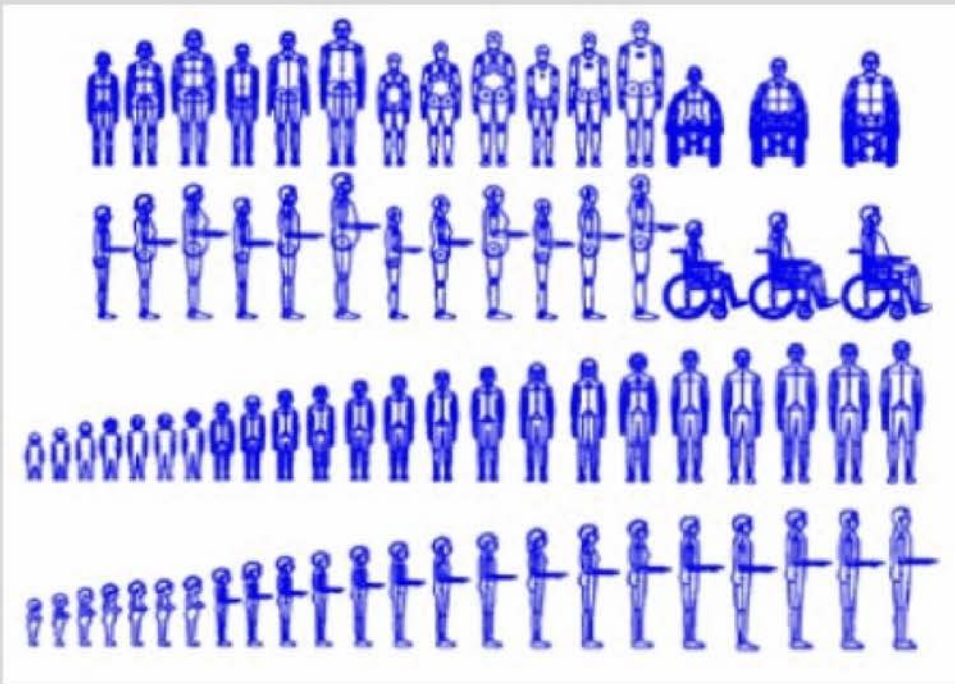
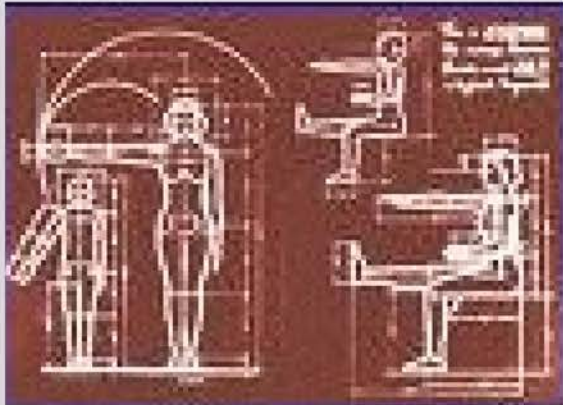

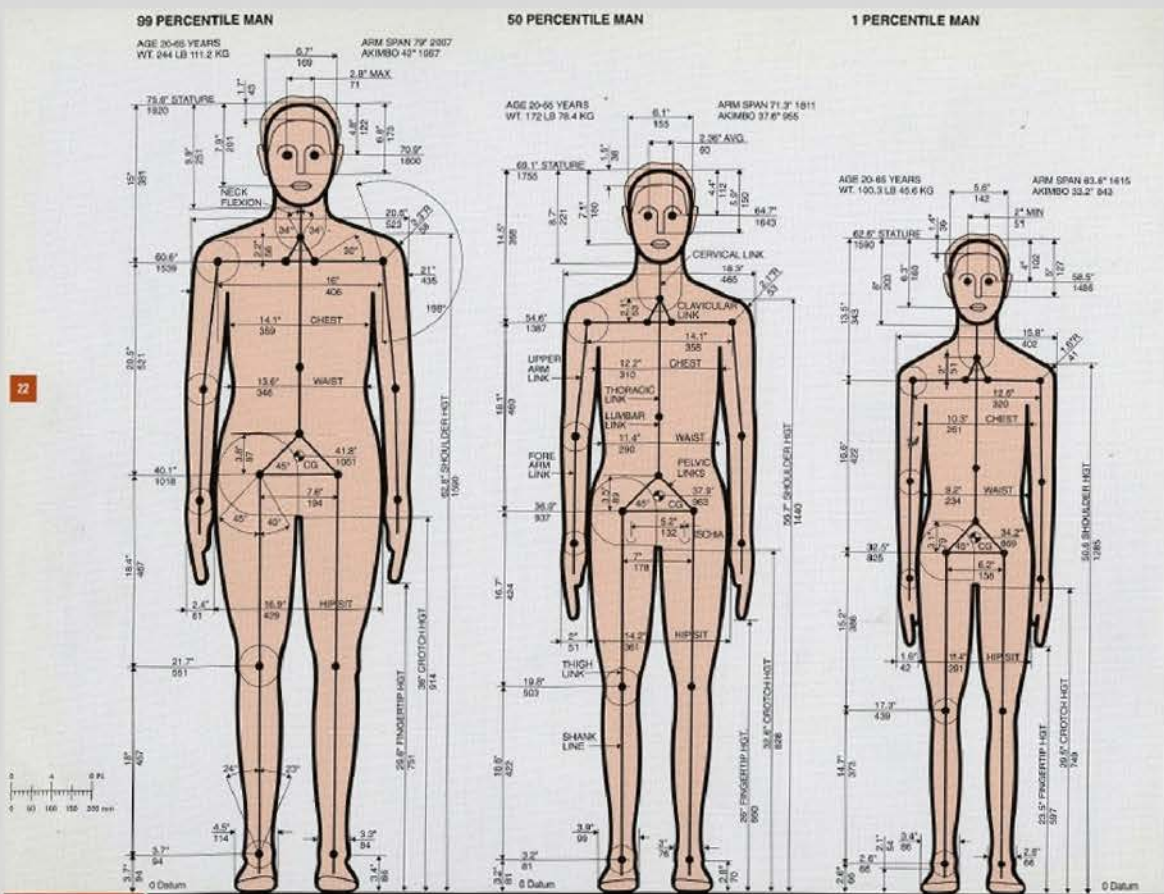
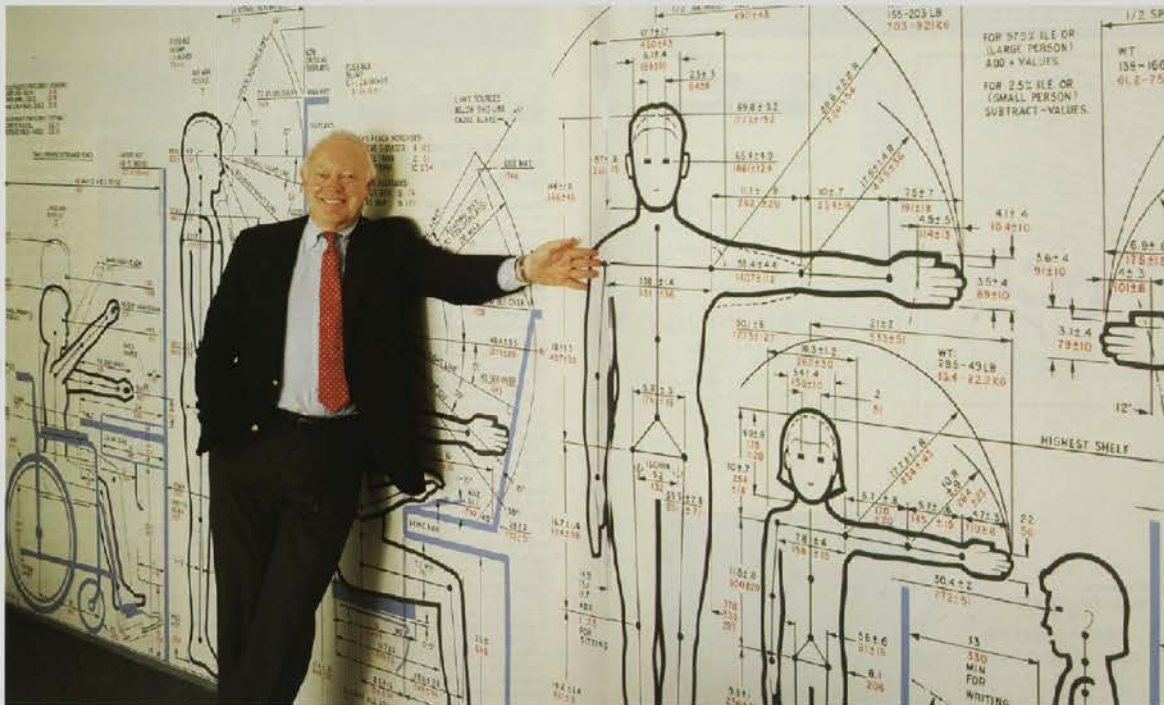

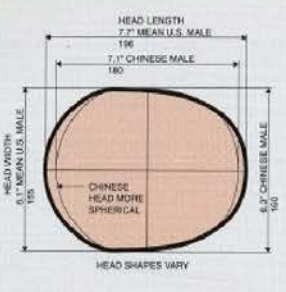
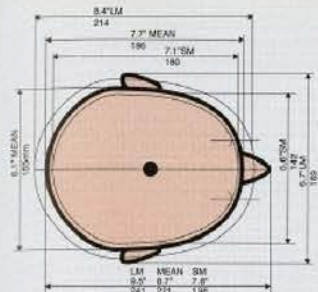
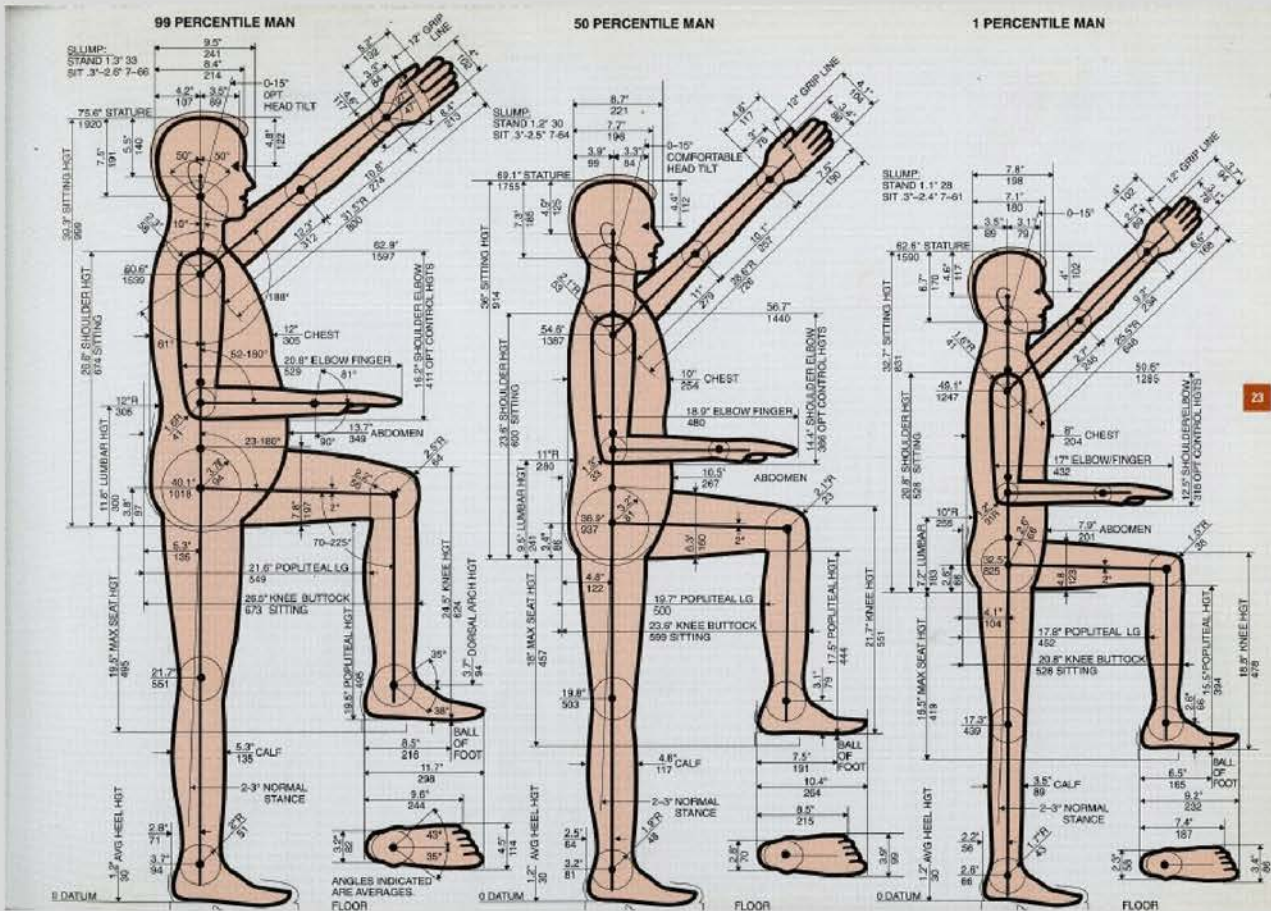

COMPARISON OF HEAD SIZES FOR AVERAGE MEN IN VARIOUS NATIONS



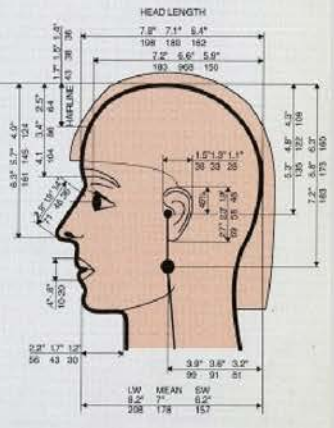
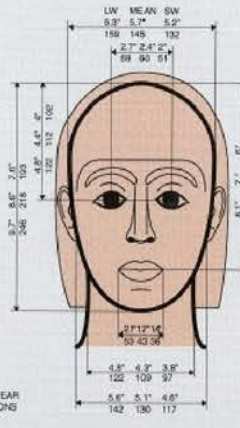
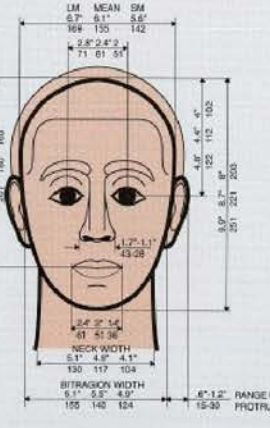
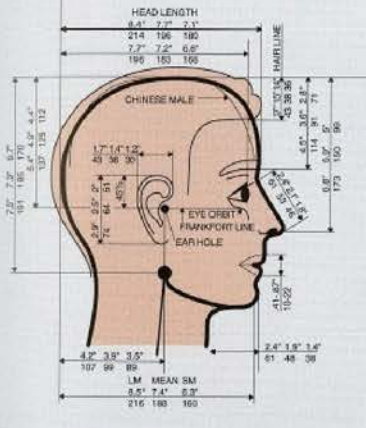
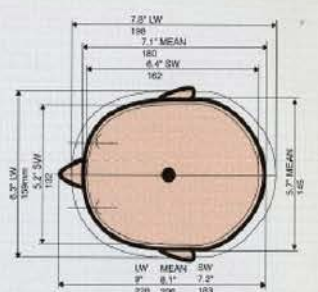

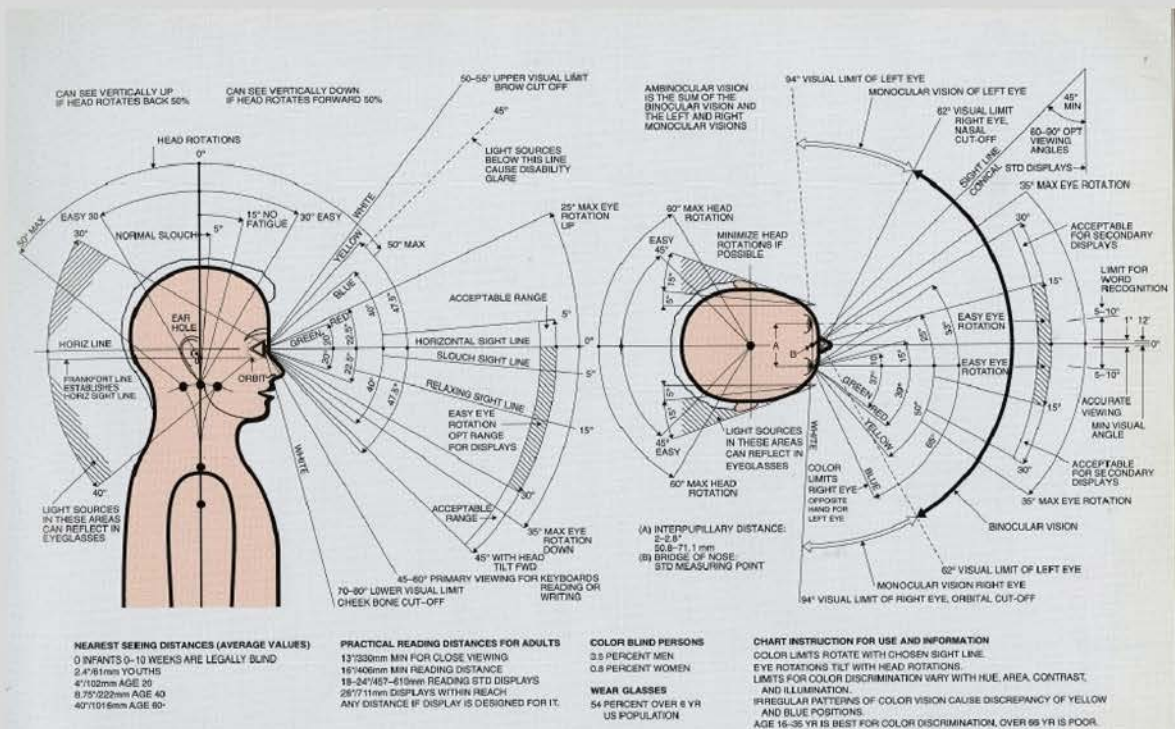
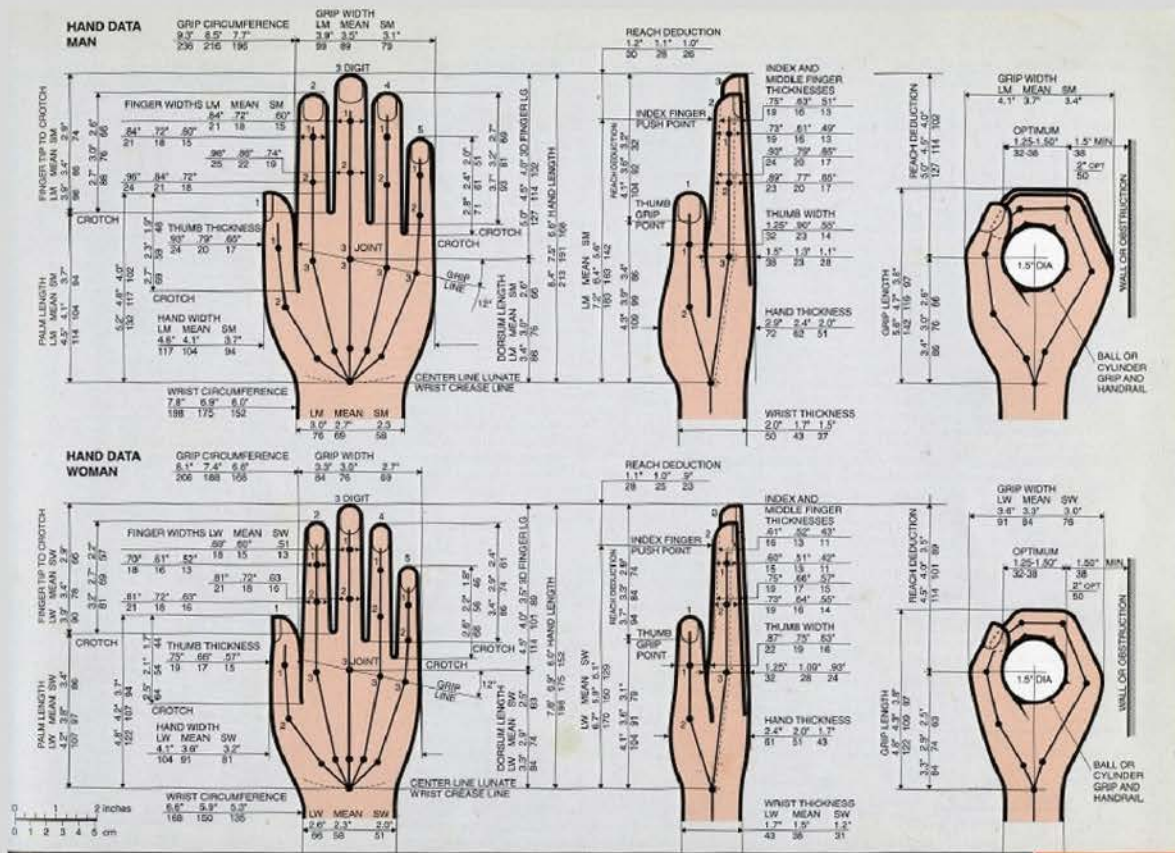



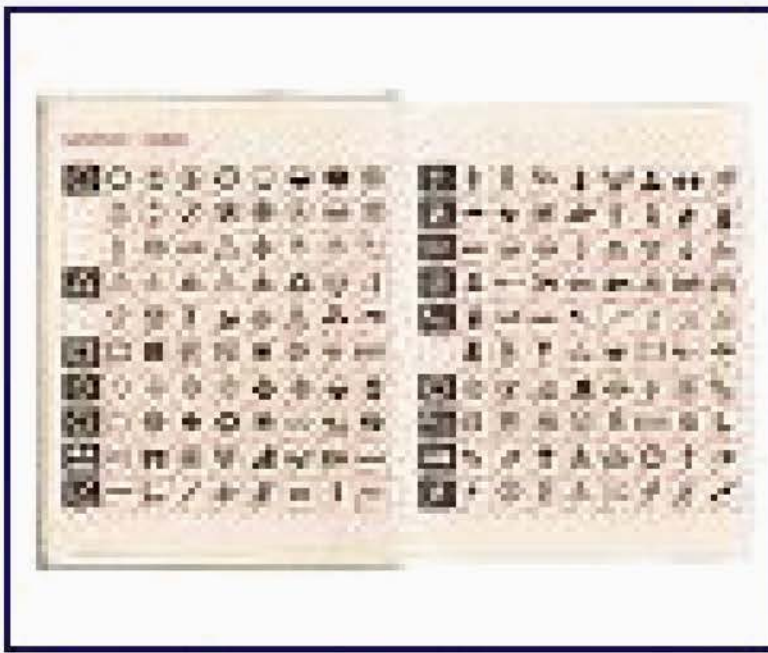
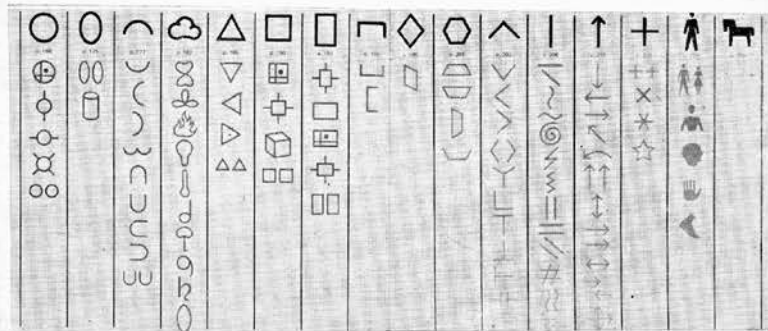
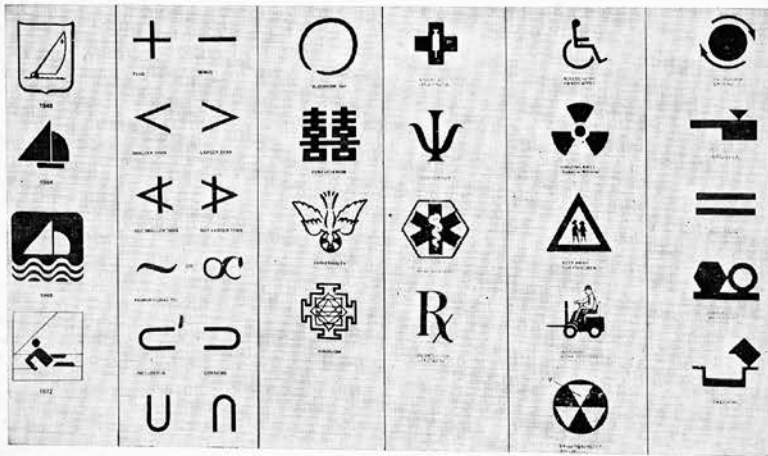
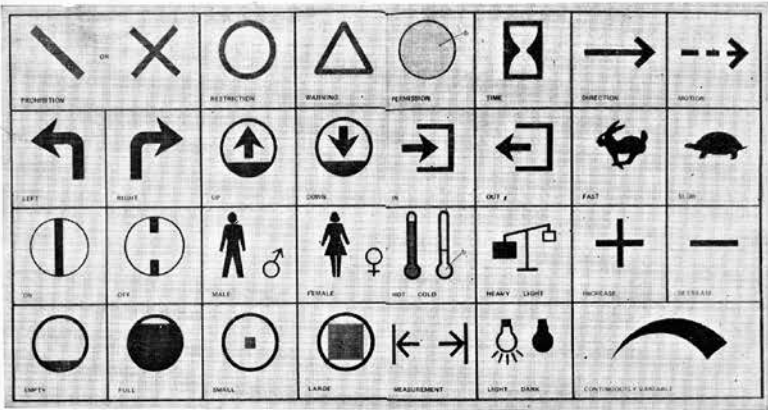











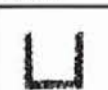
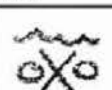
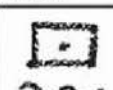







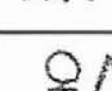

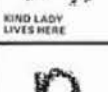
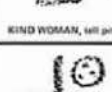

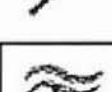



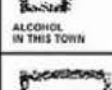

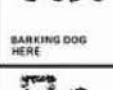
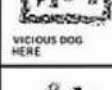
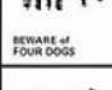
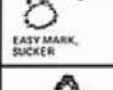
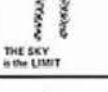
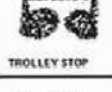

NATION	LENGTH	WIDTH
USA	7.7" (196)	6.1" (155)
GERMANY	7.7" (196)	6.1" (155)
ITALY	7.6" (193)	6.1" (155)
FRANCE	7.5" (191)	5.9" (150)
JAPAN	7.5" (185)	6.1" (155)
CHINA	7.1" (180)	6.3" (160)



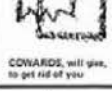

ЗНАКИ



 NO USE GOING THIS DIRECTION	 THIS WAY	 HIT THE ROAD! QUICK!	 GOOD ROAD to FOLLOW	 ROAD SPOILED, full of other hobos	
 DOUBTFUL	 HALT	 THIS IS THE PLACE	 DANGEROUS NEIGHBORHOOD	 THIS COMMUNITY indifferent to hobos	 NOTHING to be GAINED HERE
 YOU CAN CAMP HERE	 FRESH WATER, SAFE CAMPSITE	 DANGEROUS DRINKING WATER	 O. K., ALL RIGHT	 GOOD PLACE for a HANDOUT	 ILL-TEMPERED MAN LIVES HERE
 WELL GUARDED HOUSE	 THE OWNER IS IN	 THE OWNER IS OUT	 A GENTLEMAN LIVES HERE	 THESE PEOPLE ARE RICH	
 KIND LADY LIVES HERE	 KIND WOMAN, tell painful story	 FOOD HERE if you WORK	 RELIGIOUS TALK gets FREE MEAL		
 IF YOU ARE SICK, they'll care for you	 DOCTOR HERE, DON'T CHARGE	 FREE TELEPHONE	 ALCOHOL IN THIS TOWN	 YOU CAN SLEEP in HAYLOFT	
 KEEP QUIET	 HOLD YOUR TONGUE	 BARKING DOG HERE	 VICIOUS DOG HERE	 BEWARE of FOUR DOGS	 EASY MARK, SUCKER
 THE SKY is the LIMIT	 TROLLEY STOP	 GOOD PLACE to CATCH a TRAIN	 THIS IS NOT A SAFE PLACE	 MAN with a GUN LIVES HERE	 BE PREPARED to DEFEND YOURSELF
 DISHONEST PERSON LIVES HERE	 COWARDS will give to get rid of you	 YOU'LL BE CURSED OUT	 A BEATING AWAITS YOU HERE	 POLICE HERE FROWN on HOBOS	 AUTHORITIES HERE ARE ALERT
 THERE ARE THIEVES ABOUT	 CRIME COMMITTED, not safe for strangers	 JUDGE LIVES HERE	 COURTHOUSE, PRECINCT STATION	 OFFICER of LAW LIVES HERE	 JAIL

ГРАФИКА



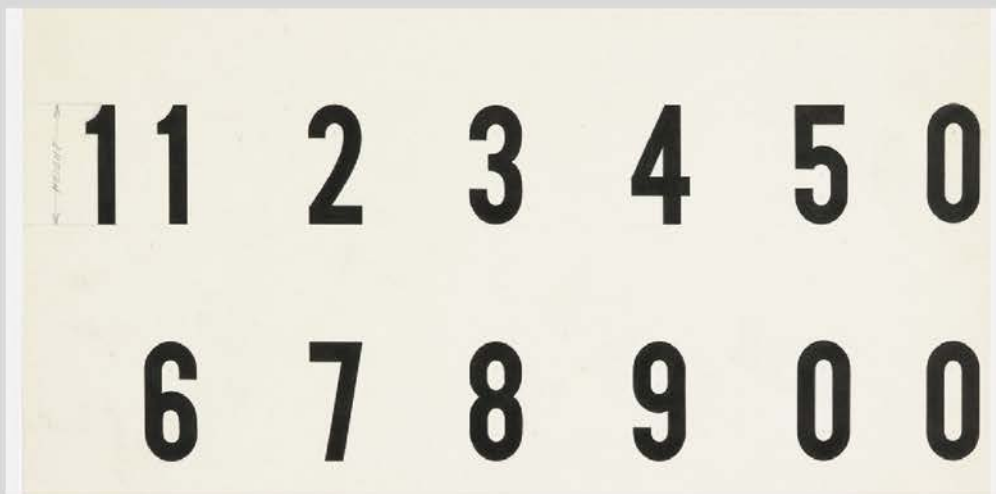

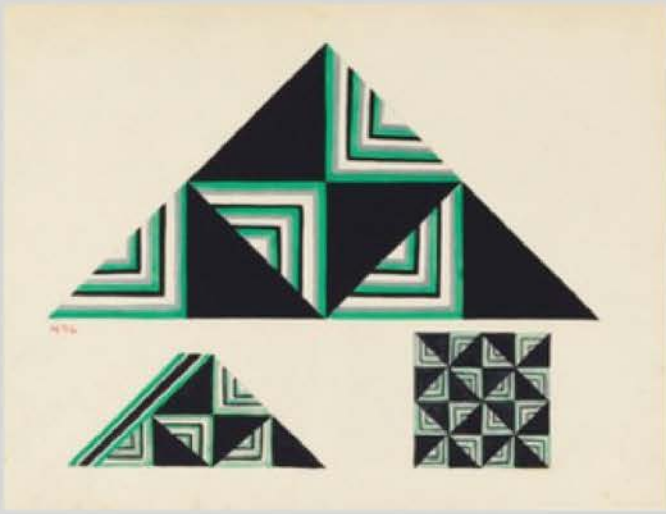

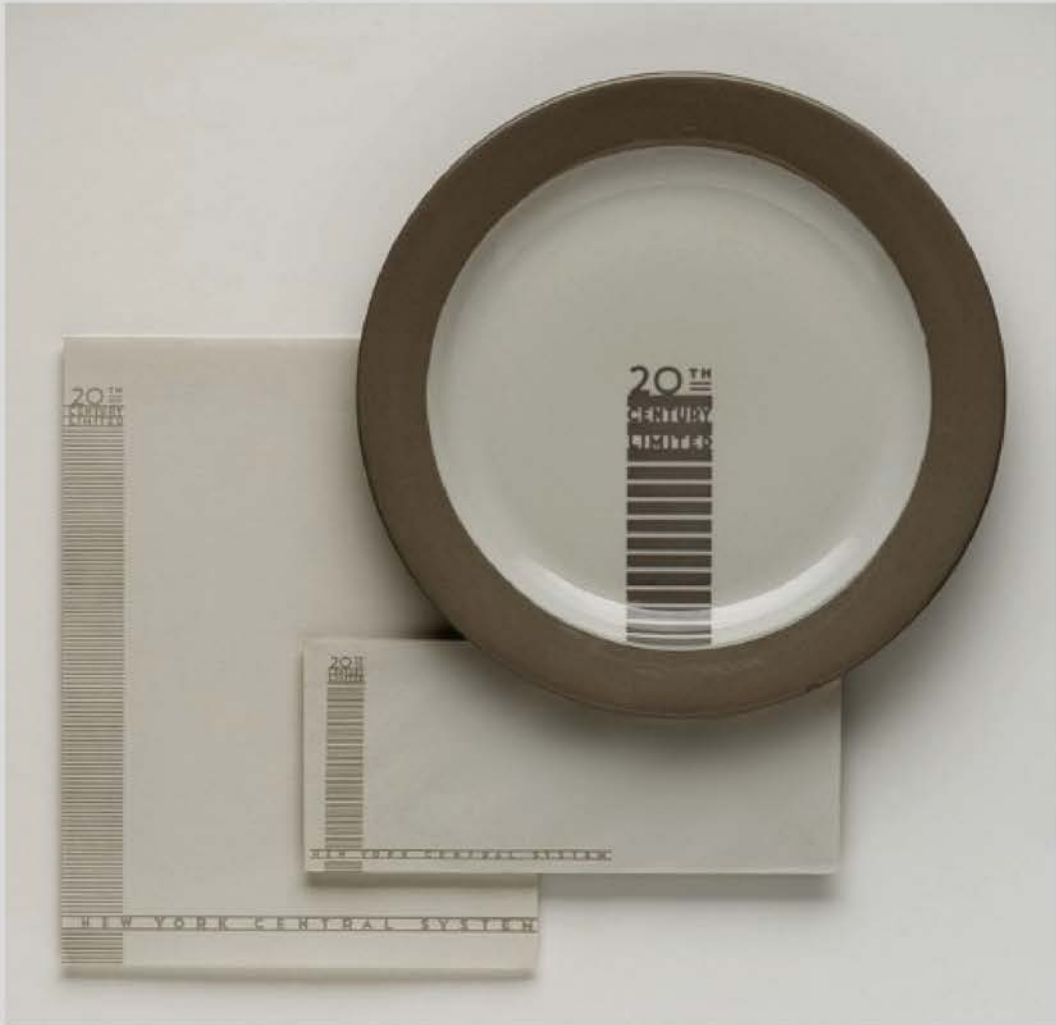

КНИГИ



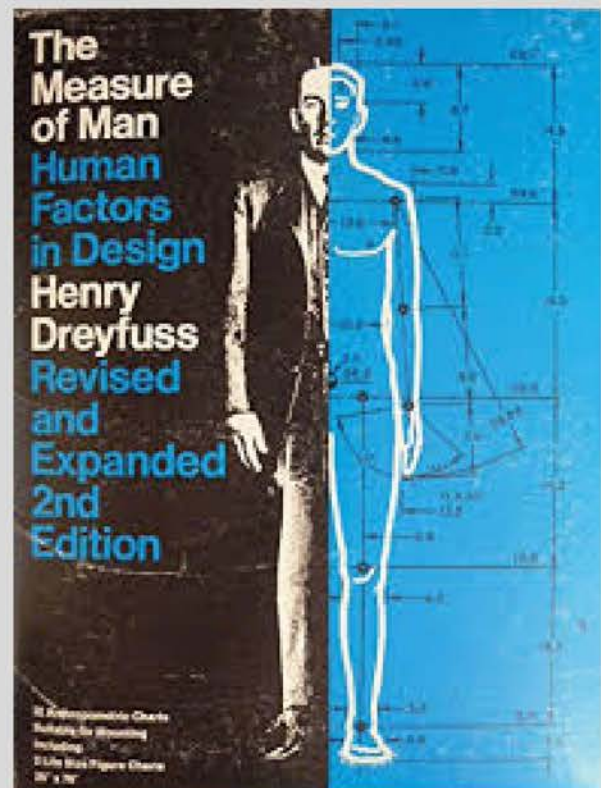
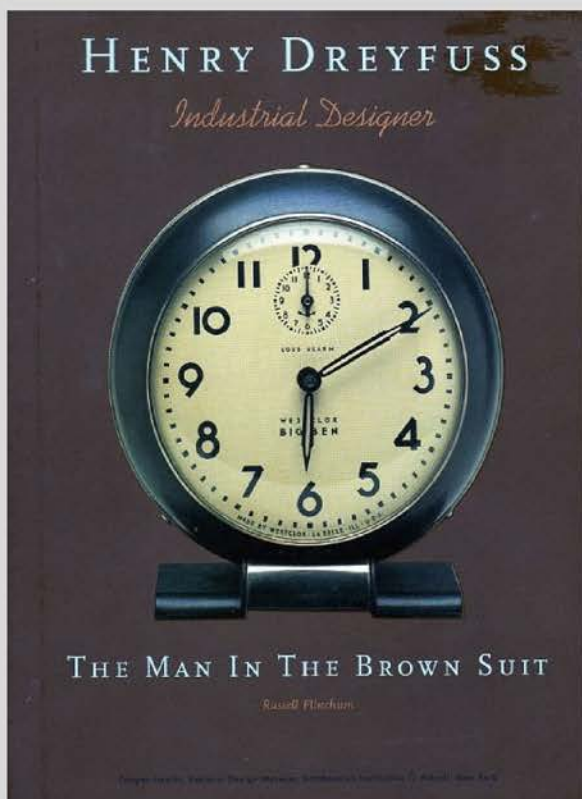
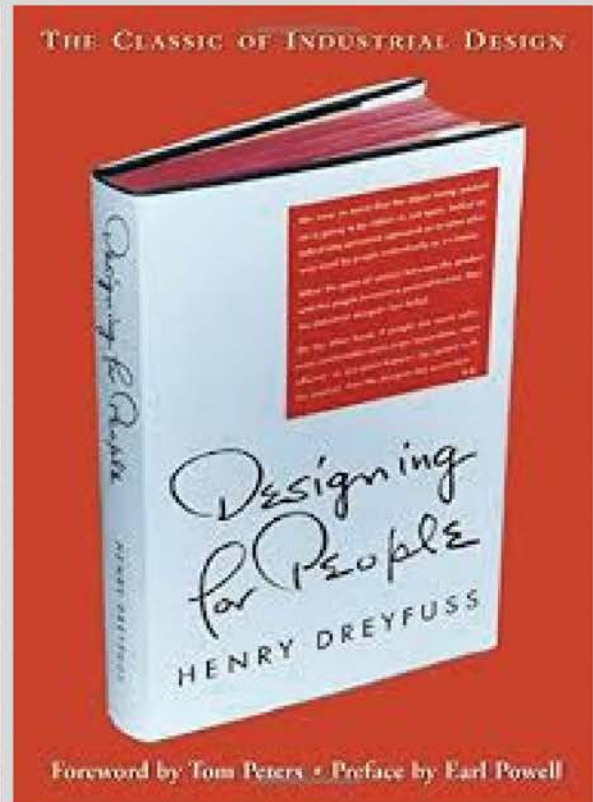
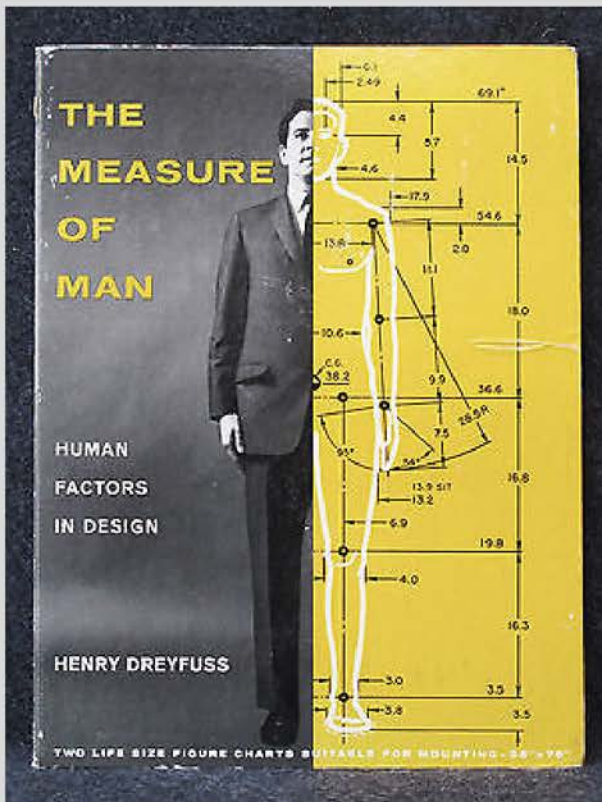

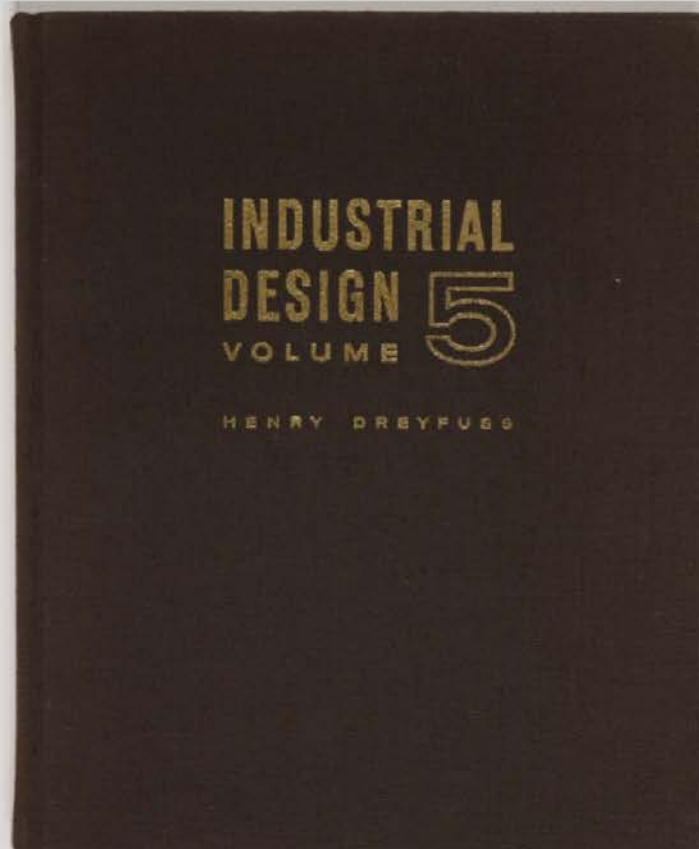
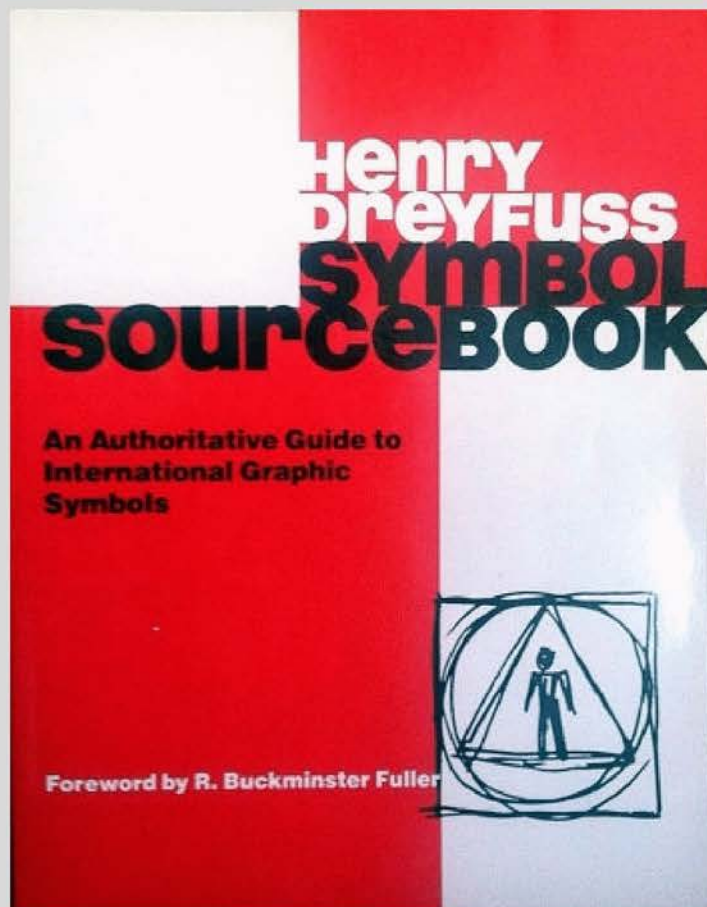

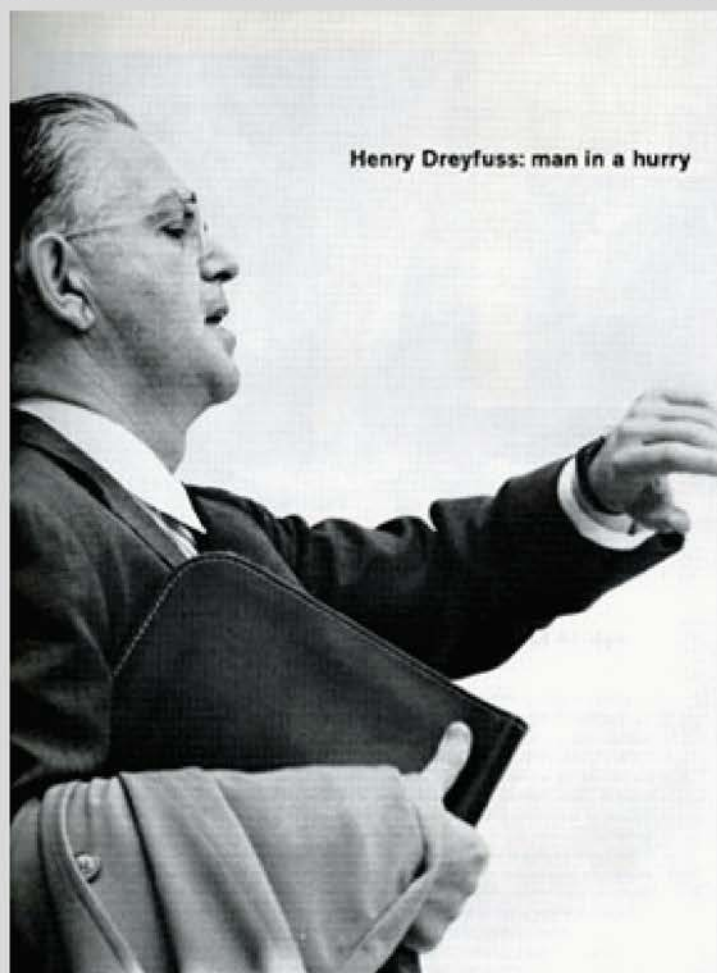

БУКЛЕТЫ



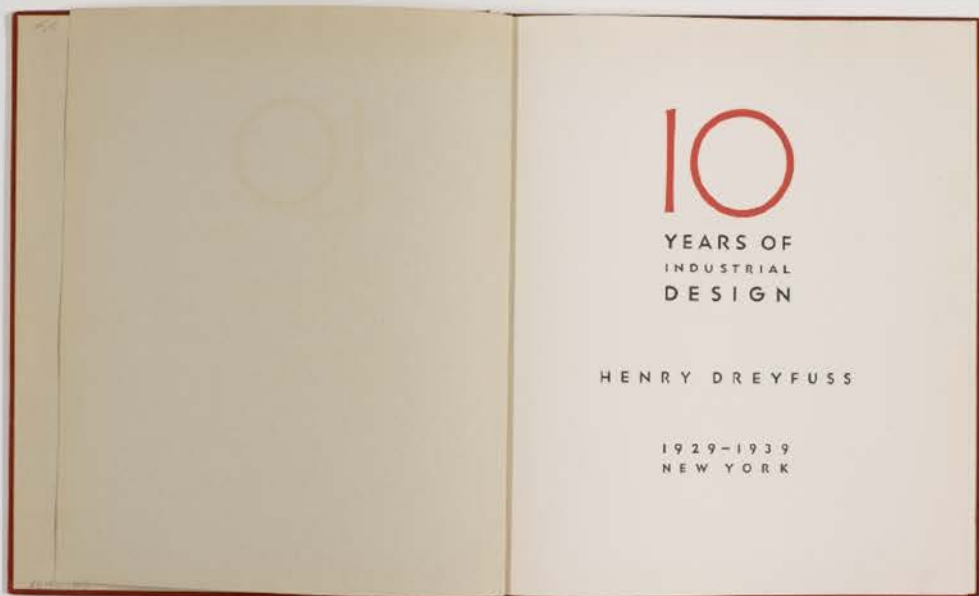
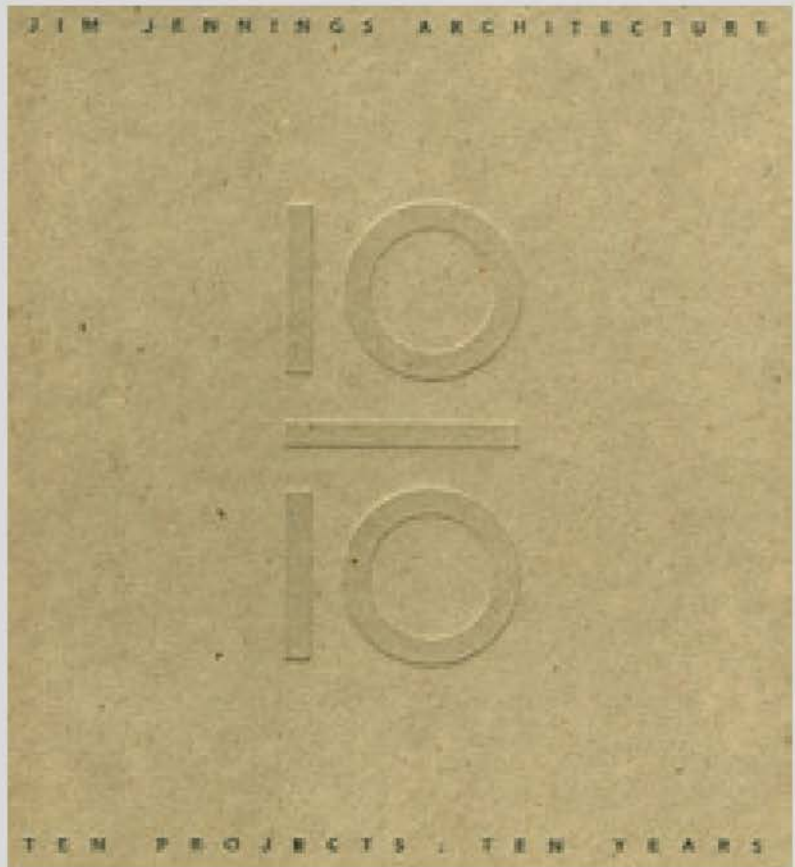



The small power-actuated bed frame, independent drawers of the new dresser, desk, table, bed and chair, and chair are coordinated with the room's lighting, all added to the effect of room. For a list of these items, see page 100.

For Martin Spector Company, Inc.



The Working Machine's distinctive design and size give the typewriter its own look. The machine's design is the result of design. The machine's design is the result of design.

For Sales, Kamin & Company



A complete set of airplane seats is made of plastic in one piece from the seat back to the seat front. This is a feature which a group of friends who have been flying from London, England, have to make it look like a simple, yet a complete. Plastic and metal construction gives the seats a modern, yet a complete. The seats are made for quick installation and removal.

For Cline Service Company



The tractor is a complete set of tractor seats is made of plastic in one piece from the seat back to the seat front. This is a feature which a group of friends who have been flying from London, England, have to make it look like a simple, yet a complete. Plastic and metal construction gives the seats a modern, yet a complete. The seats are made for quick installation and removal.

For Deere & Company



5 and 10 The kitchen set is made of plastic in one piece from the seat back to the seat front. This is a feature which a group of friends who have been flying from London, England, have to make it look like a simple, yet a complete. Plastic and metal construction gives the seats a modern, yet a complete. The seats are made for quick installation and removal.

For The Washburn Co.



The machine's design is the result of design. The machine's design is the result of design. The machine's design is the result of design. The machine's design is the result of design.

For The Royal Typewriter Co., Inc.

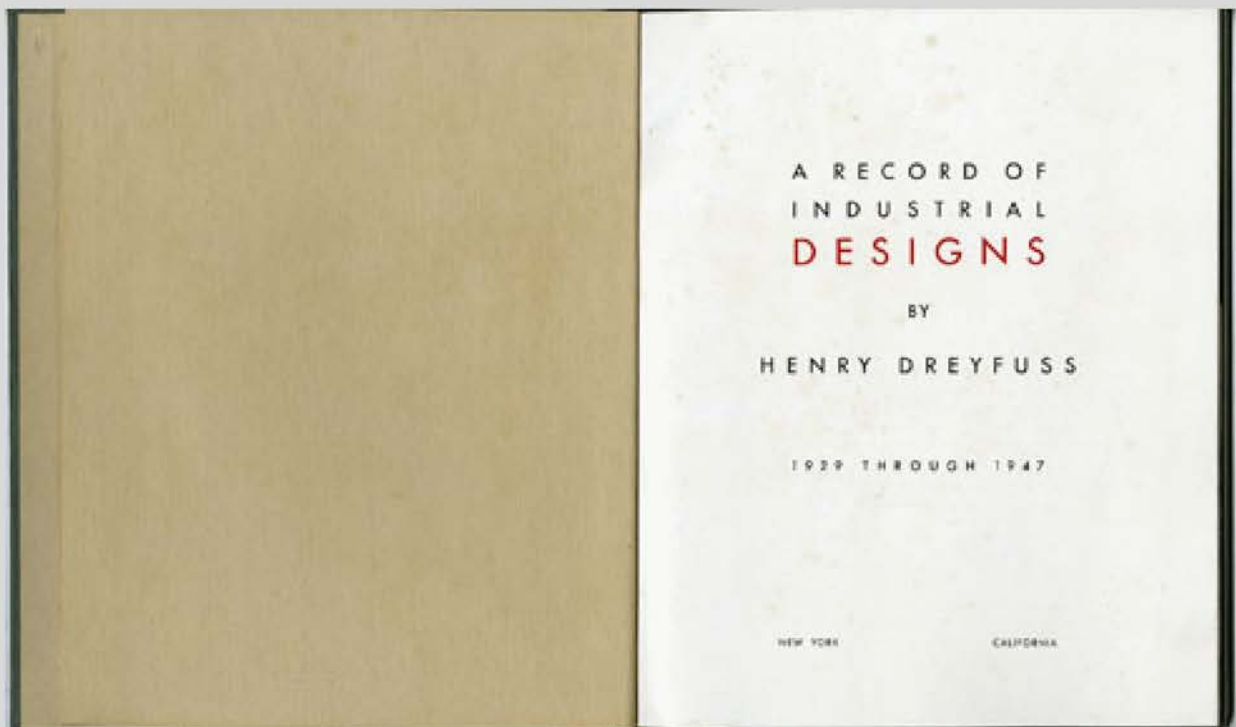
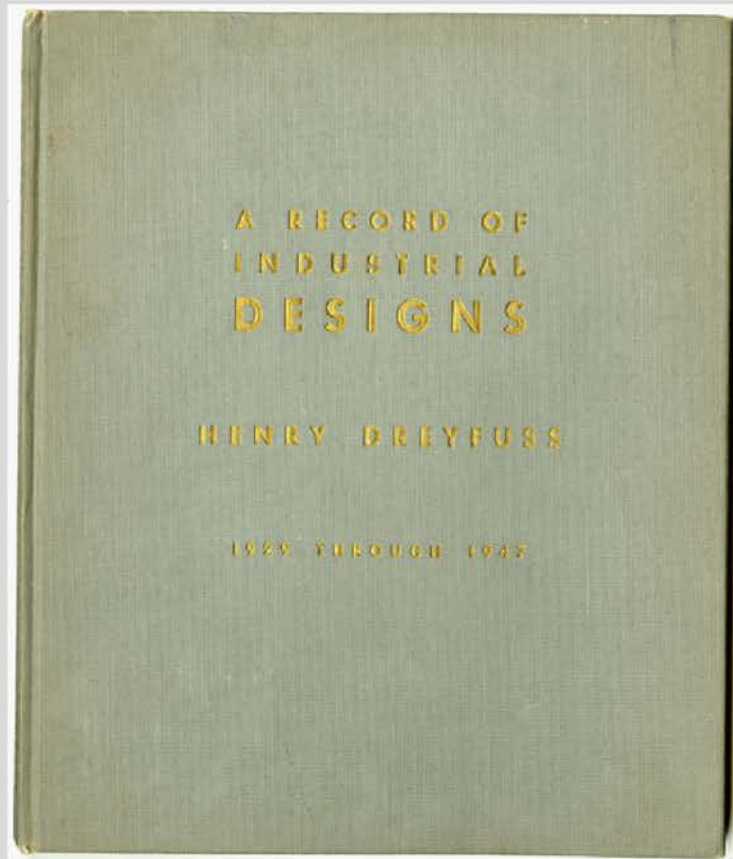



In a comparative design program, for certain commodities, the package in which the product is sold can be improved.



For Anscocolor

Improvements in lenses and shutters give amateurs a chance to make excellent pictures. The problem for the designer is to help the photographer get the best out of his camera.

In the Reflex camera, the various controls are so placed as to reduce the possibility of error—a true precision instrument in a handy and pleasing form.

The Chief is smaller, more convenient to carry and operate, than the other type (shown beside it), but the picture line remains the same.



Pilot and guests in this four-wheeled plane feel "at home," as they do in a fine car. The instrument panel is simple and clear, and safety is designed into the operating

section by eliminating all protruding controls at critical areas. A custom wagon interior, capable of carrying large loads, is also available.

For the Consolidated Vultee Aircraft Corp., Division Division... since 1942



By this new line of the top semi-automatic wrist watch, the designer has made a new product in its class. The finished design was the first in its class to be produced in a simple, clean, and modern form. The watch was designed during the war, yet, at the end of some years, the clock is still up-to-date and still selling.

For Weston Division, General Time Instruments Co.



The typewriter is an important machine that is used by the business man in the office. The designer could not neglect quality. This is a hard-line, well-proportioned machine, compact, sturdy, and reliable. The type font is similar to the one used in the office, and the accuracy of the printer has been kept as high as possible.

For the Royal Typewriter Co., since 1936



For the Hoover Co., since 1934

Womens are the chief buyers and users of steam irons. These two elements are designed to satisfy their demands for a cleaner that is light to handle (plastic) and now always are used, compact for storage, and attractive in form. The cylinder chamber is provided with slots that cause their marks from the top. The upright, chaser, slides smoothly under the fabric, and a light helps to check corners. The new iron is a complete piece. The handle is an integral plastic and incorporates a thumb rest. The large heat regulator dial makes for easier setting and disperses the heat effectively.



ФОТОАЛЬБОМ











Н.Н. Александров

ГЕНРИ ДРЕЙФУСС

Альбом

Henry Dreyfuss



Born in Brooklyn, New York on March 12th in 1904.

2017

1458

Н.Н. Александров

НОРМАН БЕЛ ГЕДДЕС

Norman Bel Geddes



2017

АРХИТЕКТУРА





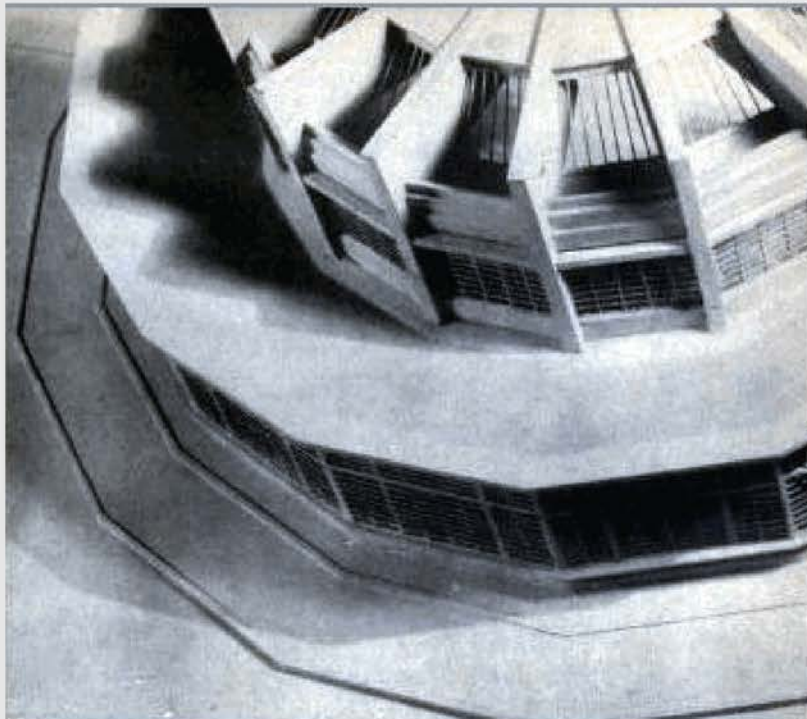
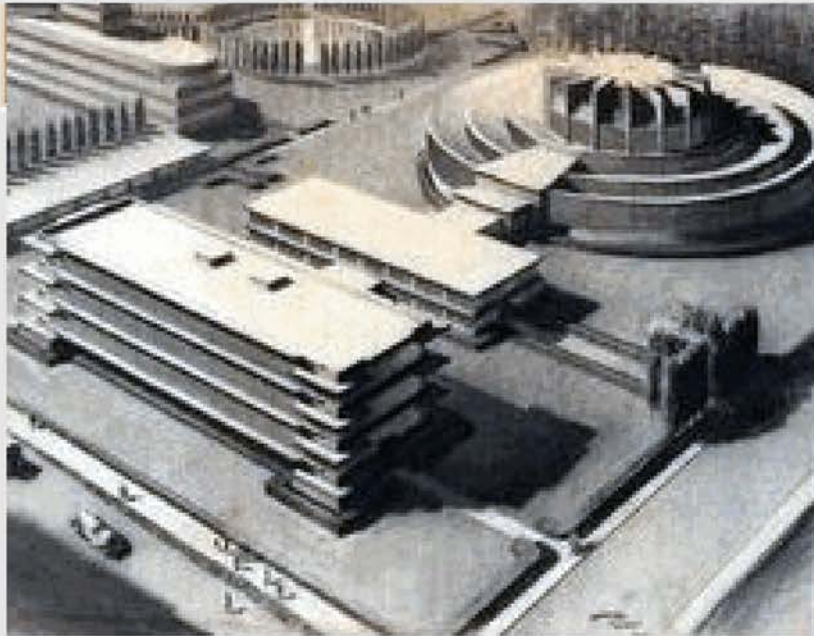
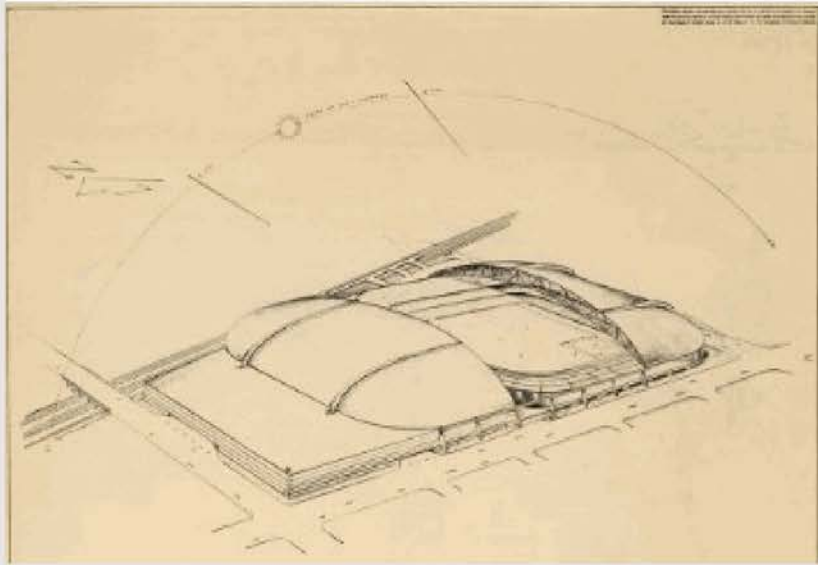

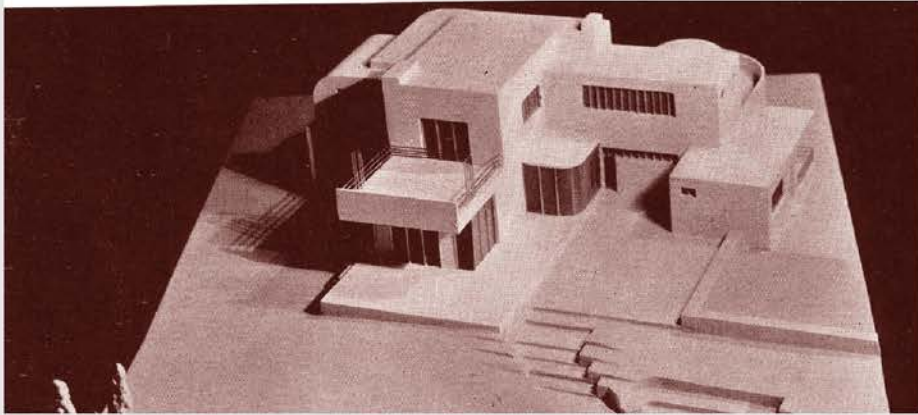

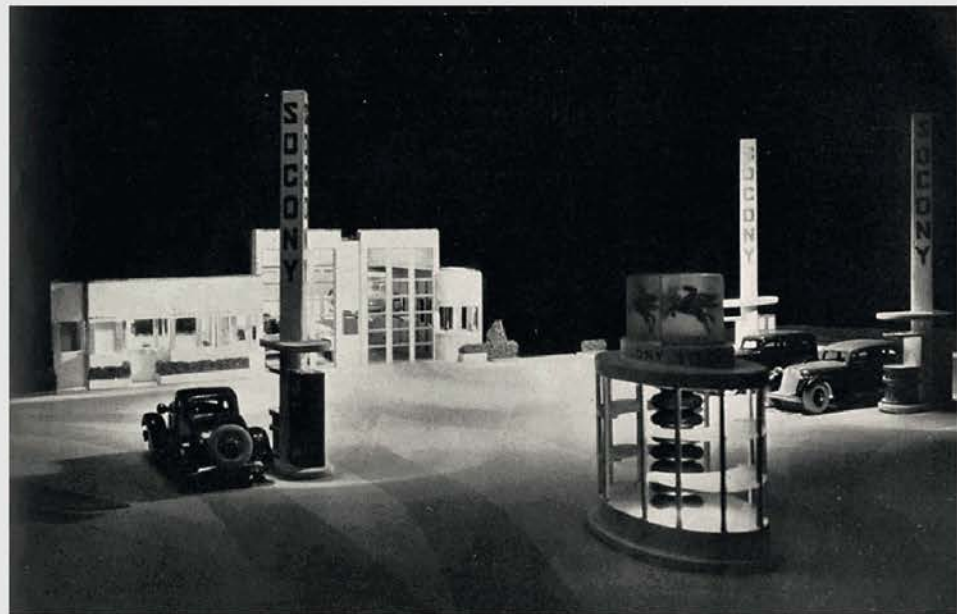
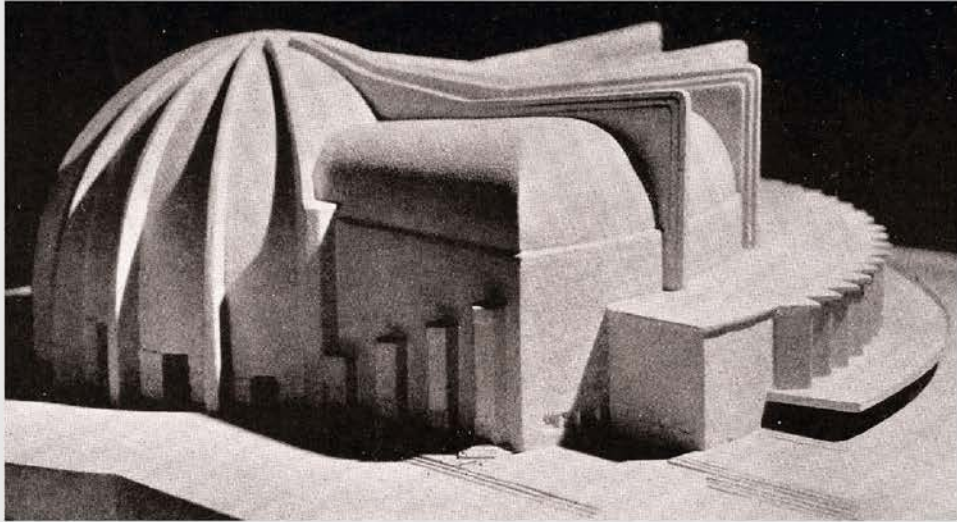
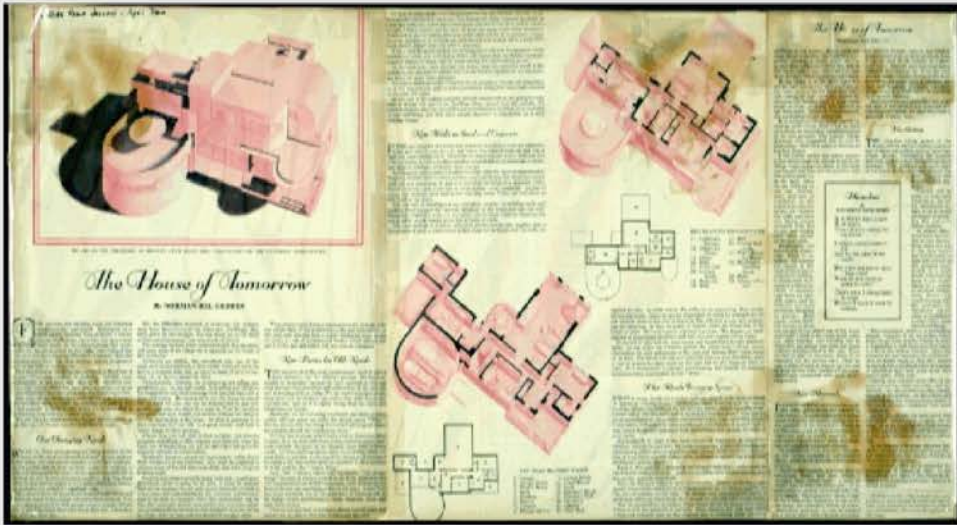

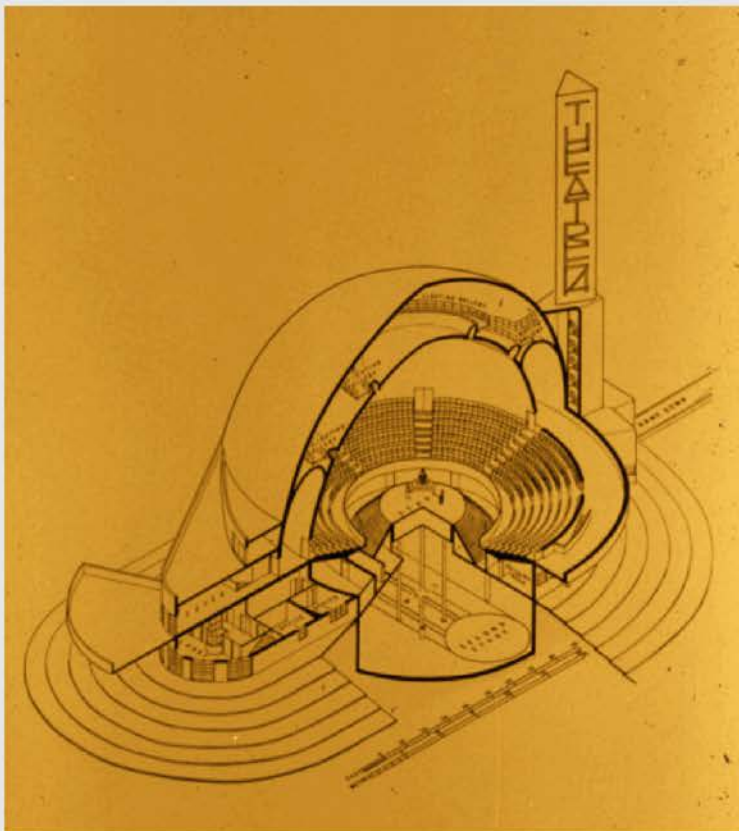
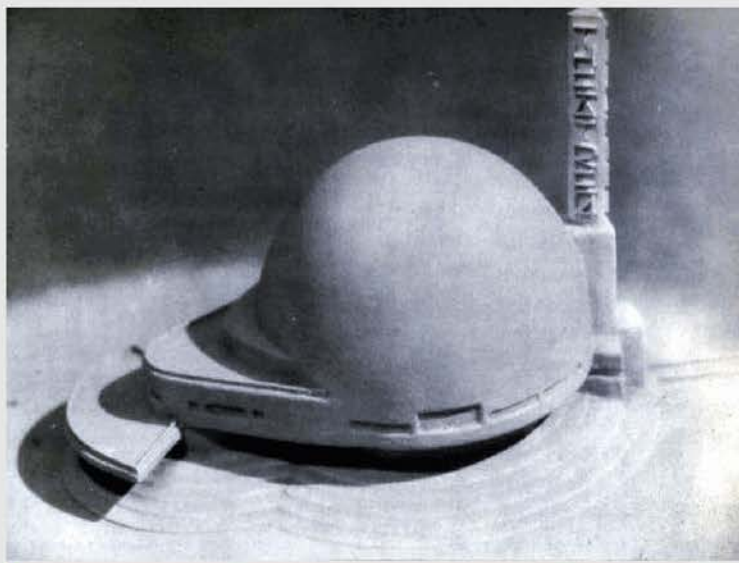
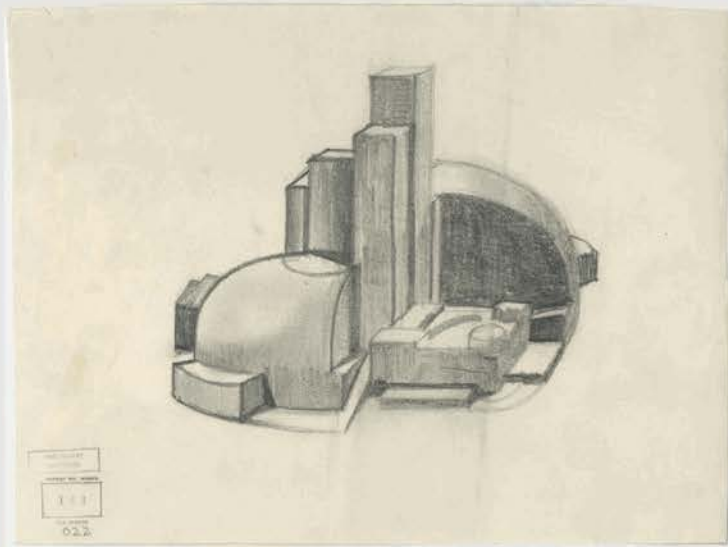



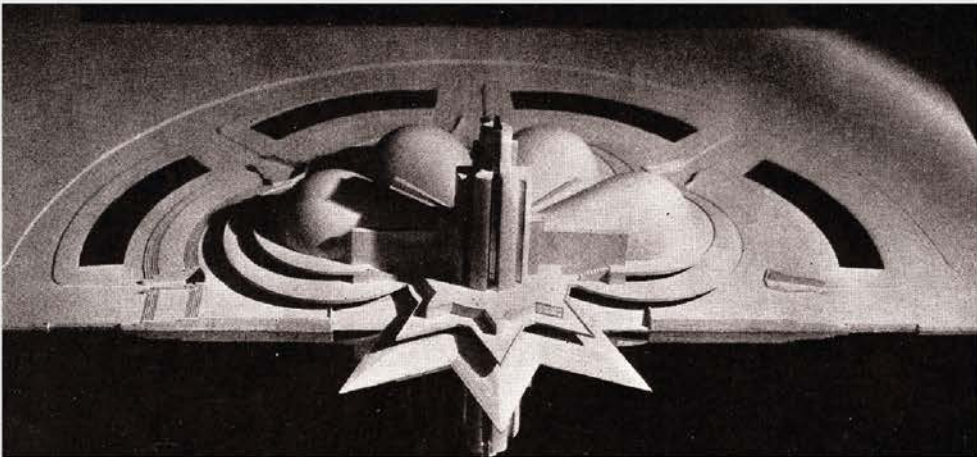
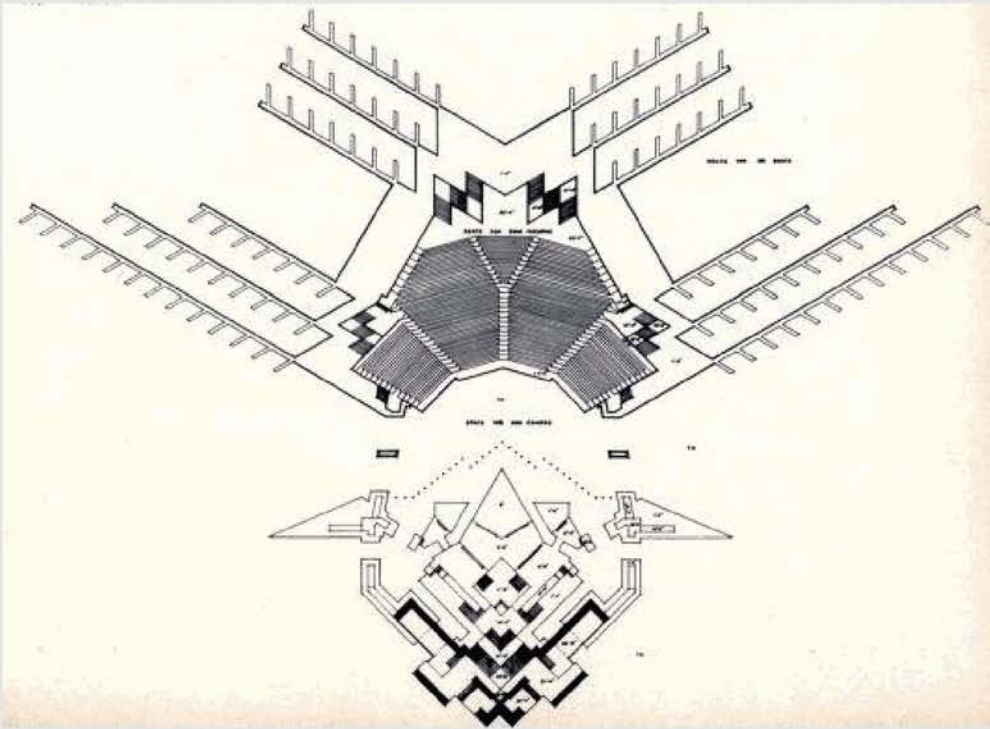

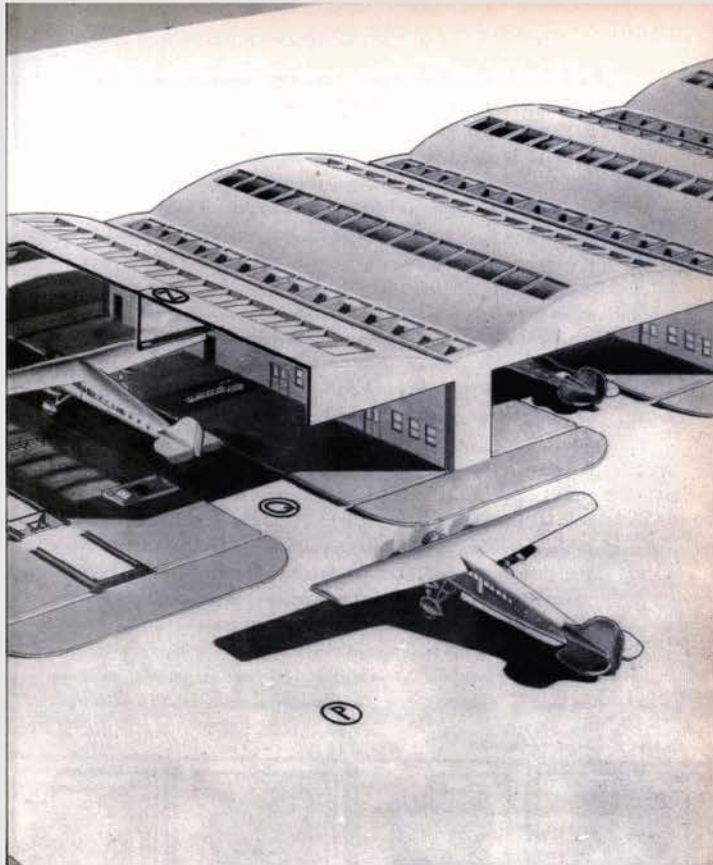

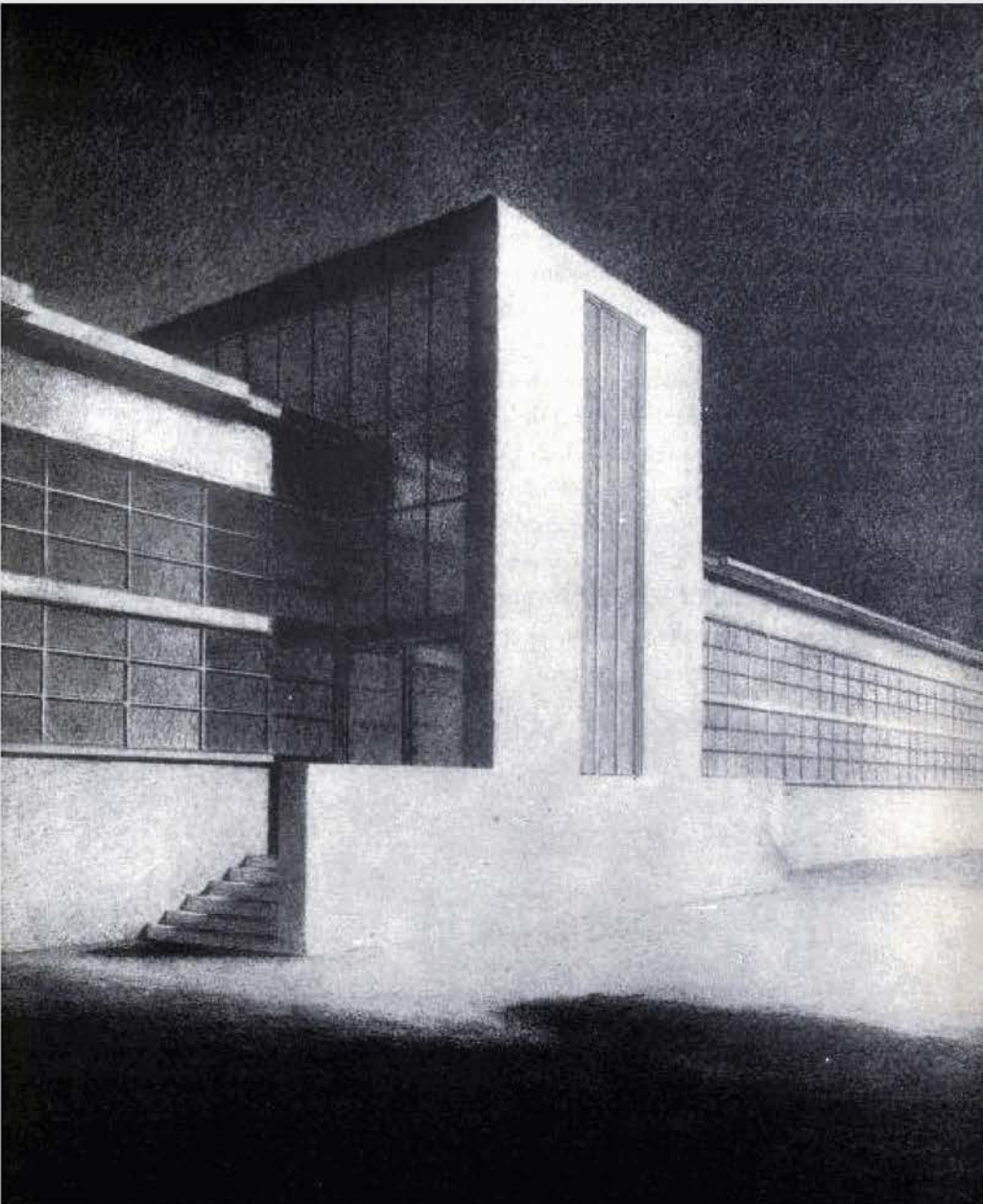
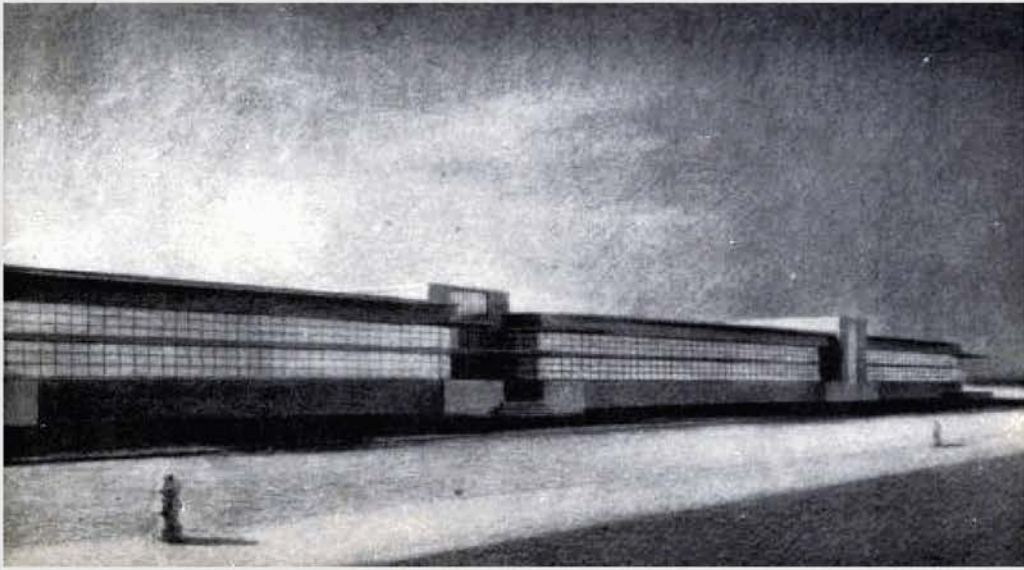



WALLACE BENTON 1934



WALLACE BENTON 1934

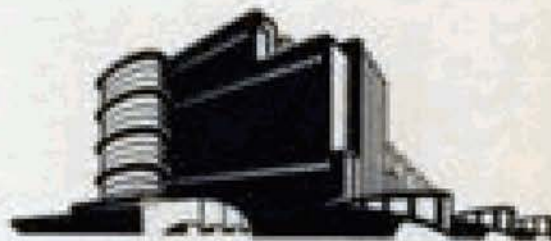

WALLACE BENTON 1937



ΦΥΤΟΥΡΑΜΑ



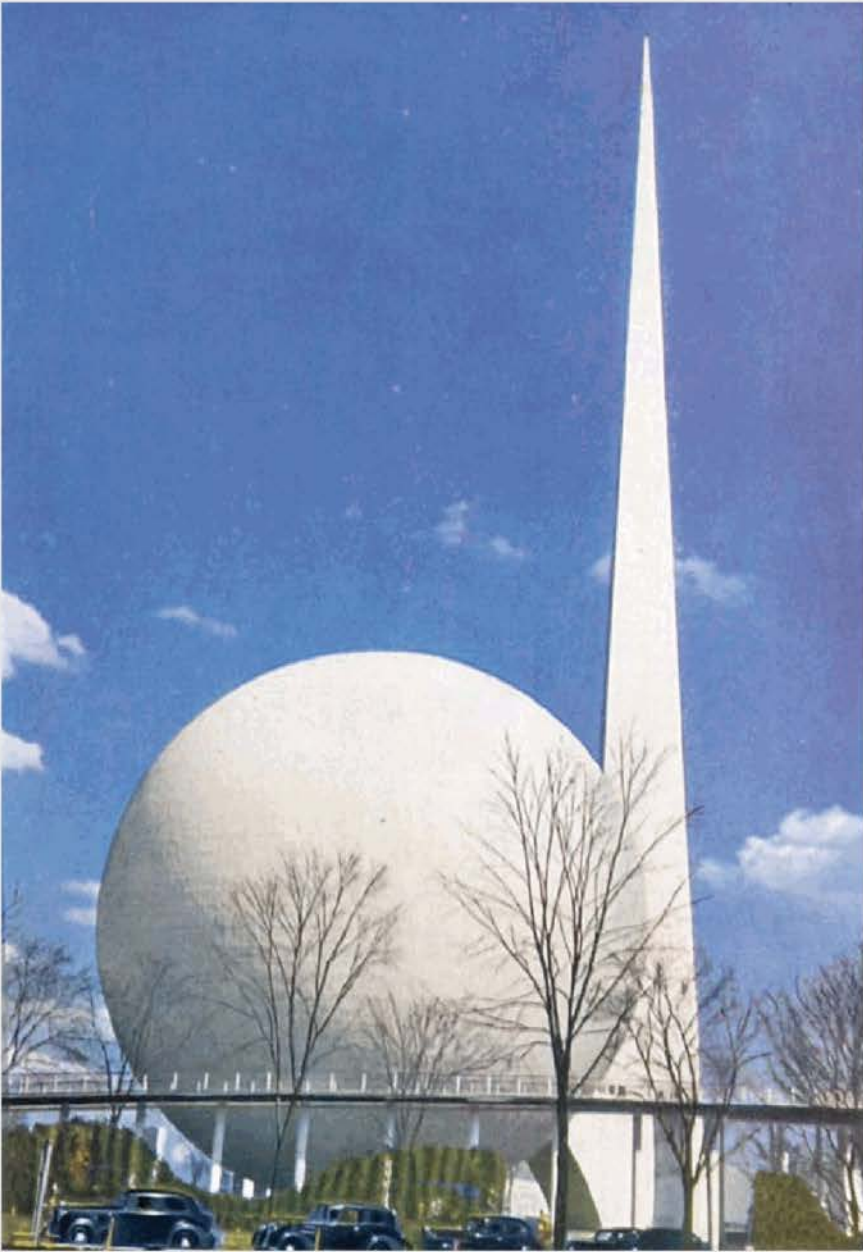



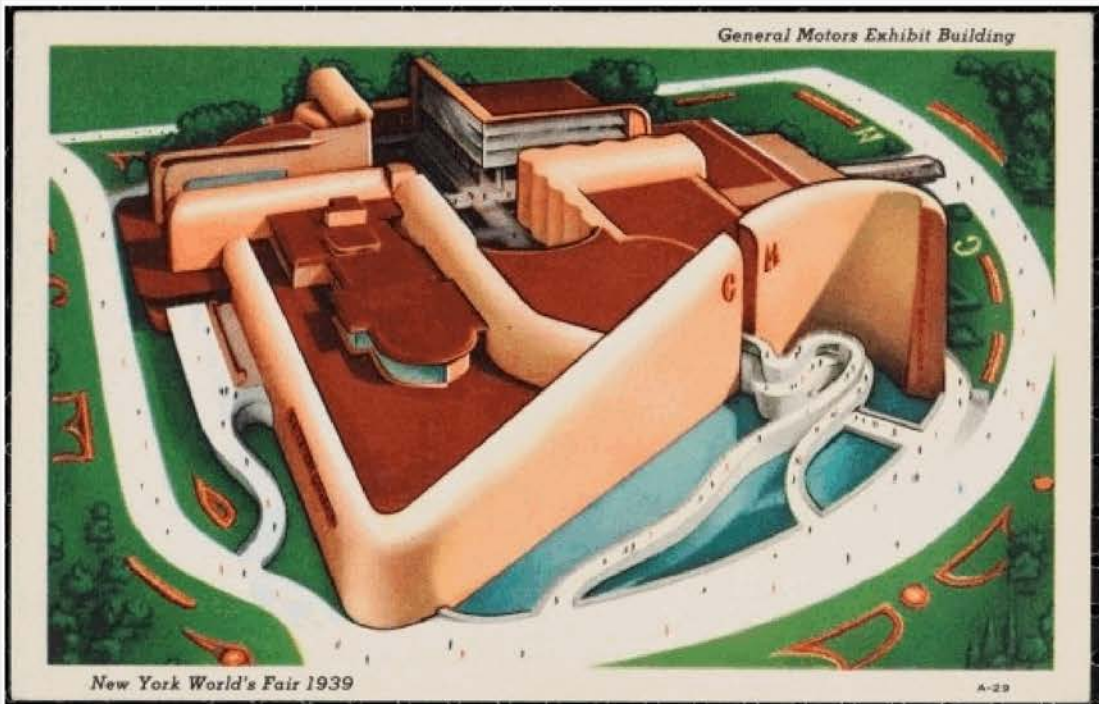



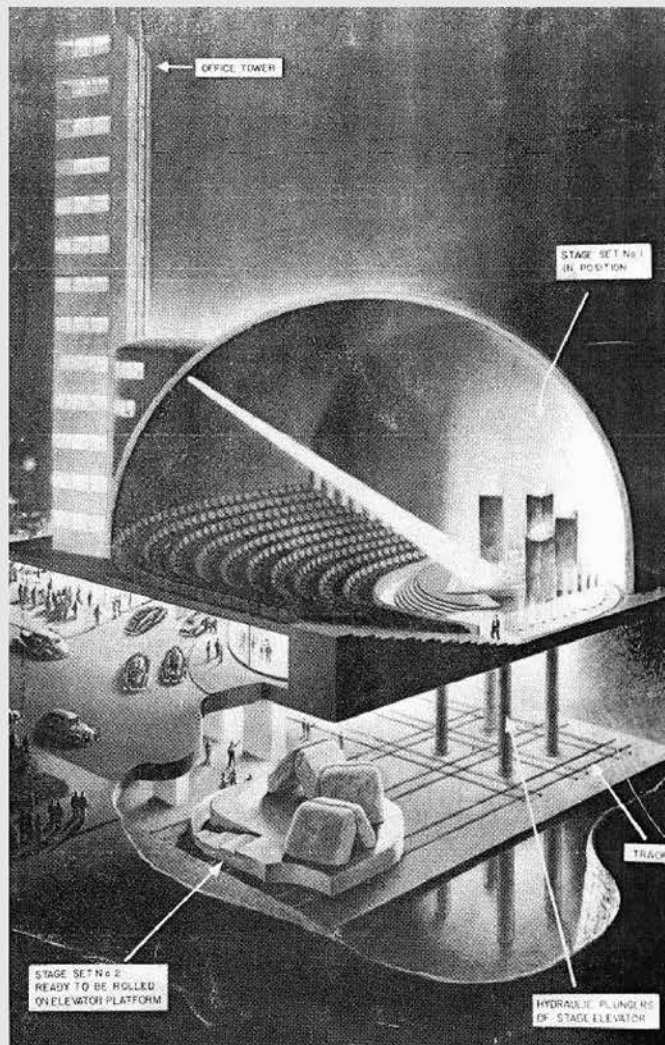

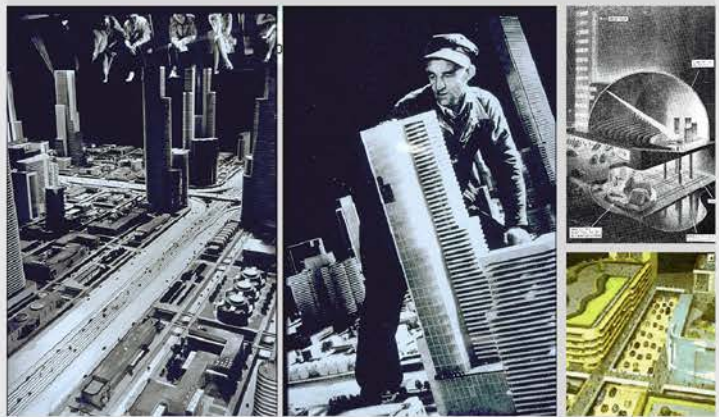
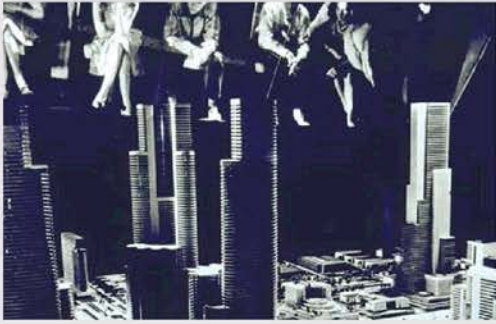

Some Photo by Richard Garbutt

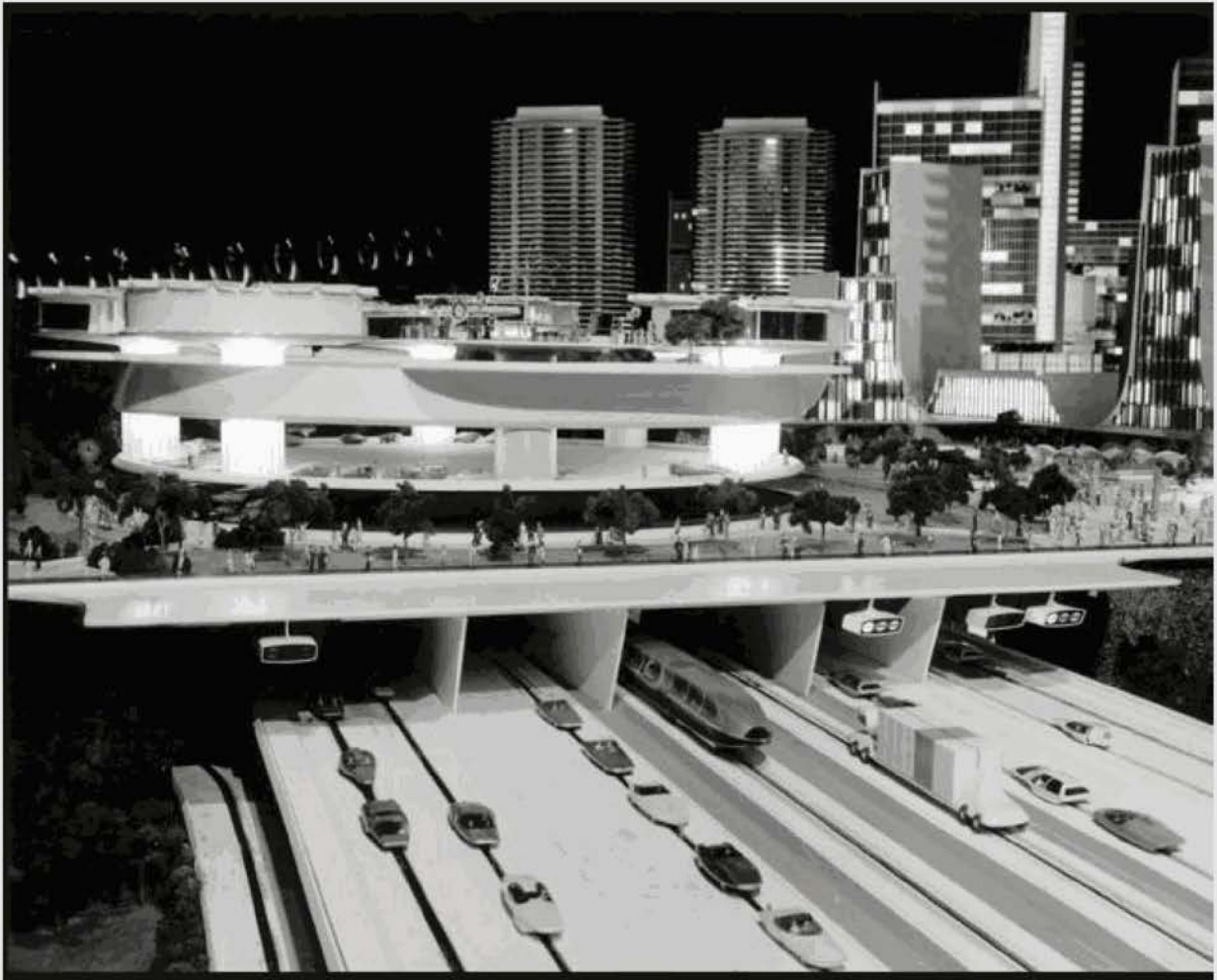
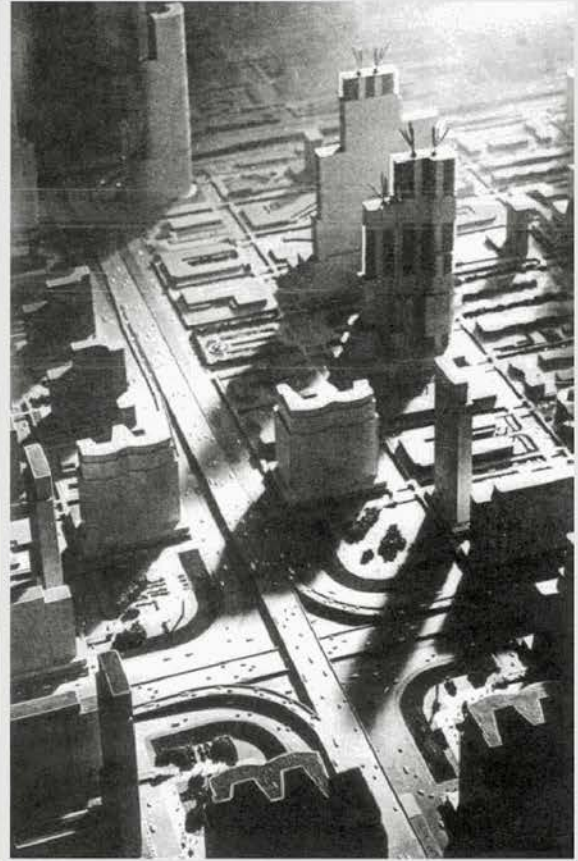
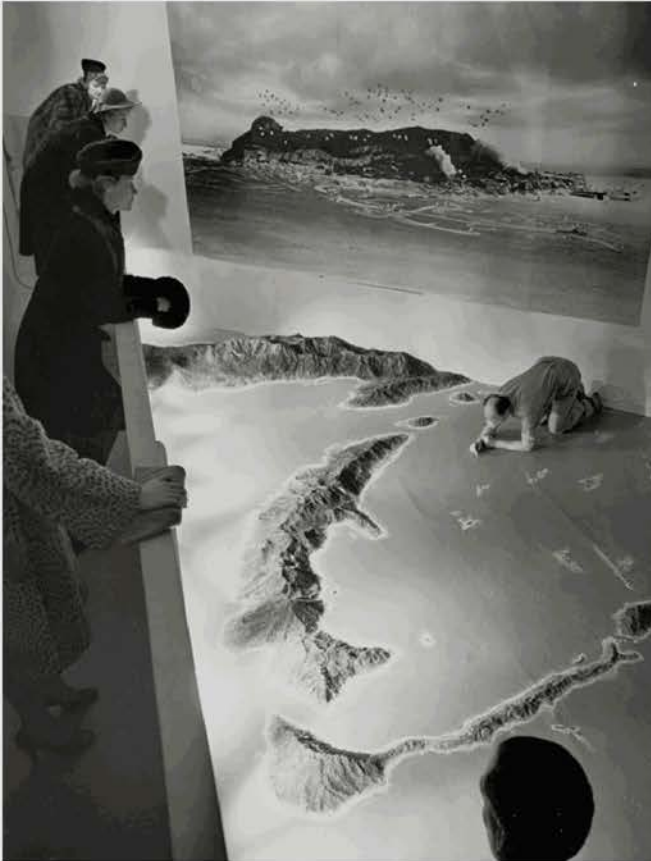

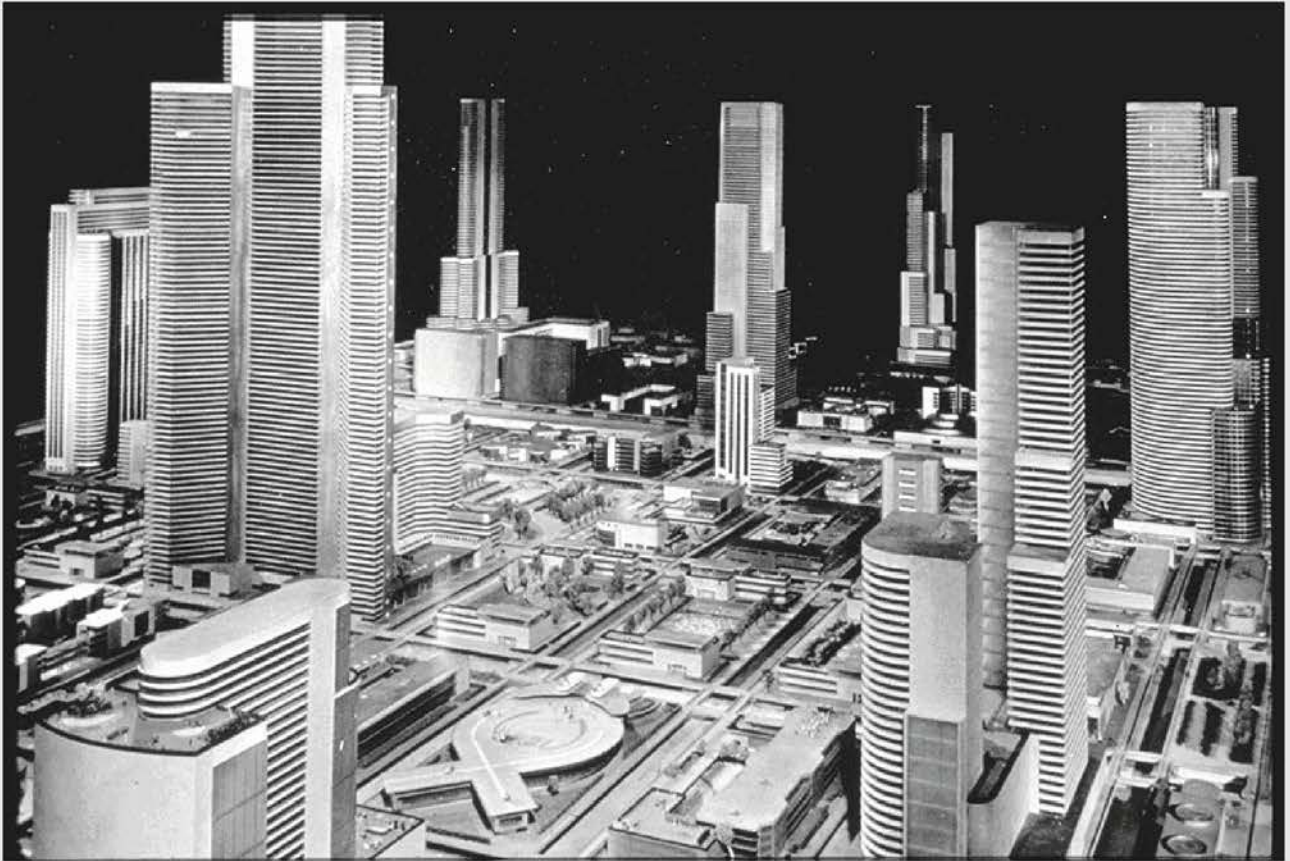

*Through the City of TOMORROW
Without a STOP*

—predicts
NORMAN BEL GEDDES

All vehicles will be moved through the city of Tomorrow through a special, regulated traffic system of aerial roadways, says Mr. Geddes, an expert on future trends.

A network of 30 miles of new Express Highways in the city will handle all traffic, leaving the streets to cars, creating a continuous flow of cars unimpeded by stop lights, intersections or pedestrians.

The road network, the aerial cableways will carry pedestrian traffic above streets, building entrances and shop windows will be an unobstructed flow. Trucks will be parked in special lots near transit buildings. Thus the entire traffic of tomorrow building line in building line will be clear for motor traffic.

**.but TODAY,
4 miles in 5 are
Stop and Go**

You can drive up to ten miles on the amount of gasoline needed for your 30 daily stops—the nation-wide average!

The costliest kind of driving cost also, both in time and money, is stop and go.

While traffic authorities are planning "the City of Tomorrow," Shell engineers have developed a fuel, Super-Shell, to meet today's driving problem (DODS).

Automotive engineers refer to Super-Shell as "motor-deg-tide," so quickly and completely it is energy changed into power... at 111 motor speeds.

You'll cut the cost of your stop-and-go driving by the regular use of Super-Shell Gasoline. There's a Shell dealer in your neighborhood.



SUPER-SHELL

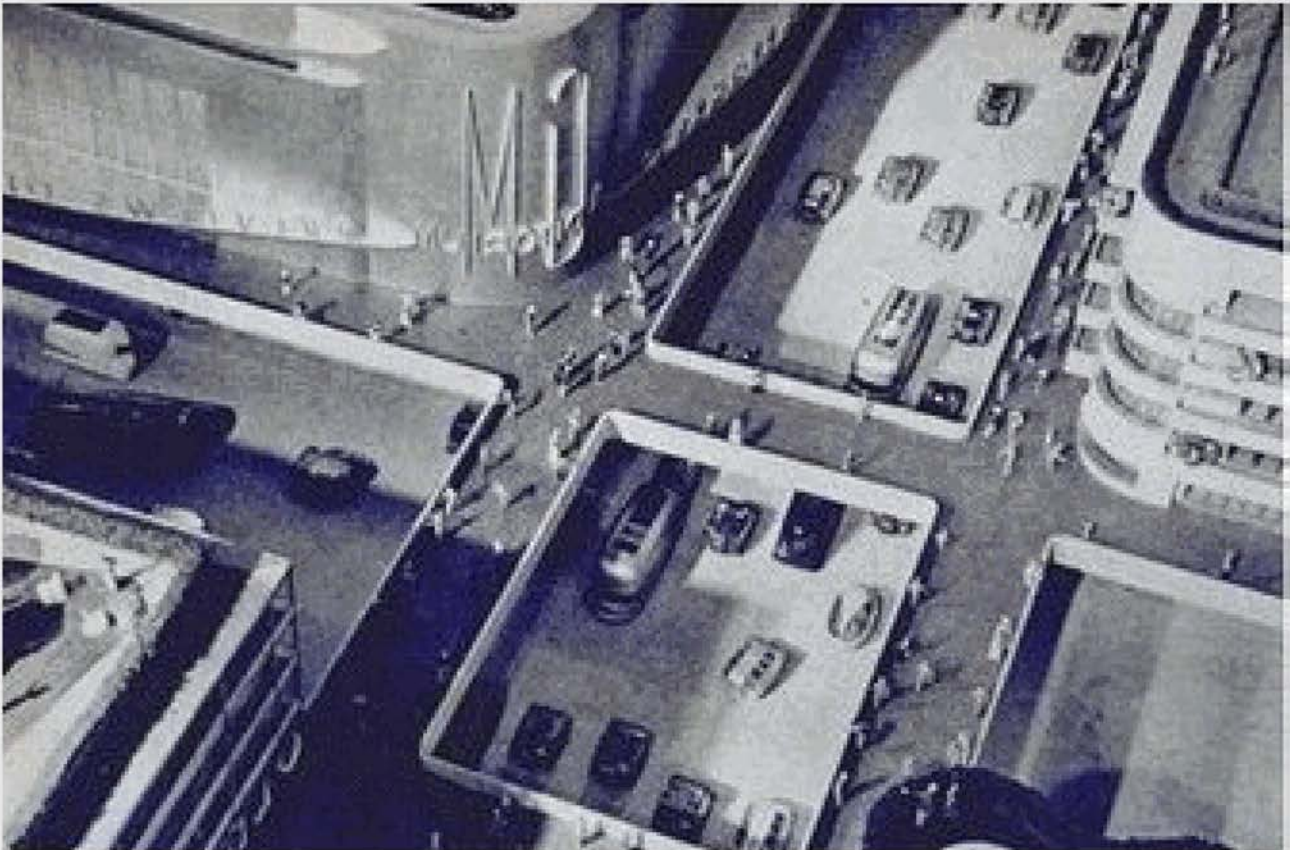

MOTORISTS OF 1960 WILL LOAF ALONG AT 50—RIGHT THROUGH TOWN

Advertisement

CONSUMER's reputation of traffic jams...
 Up at these different speeds will not
 help's confusion in the City of Tomorrow...
 "Don't be late to or miss, you'll see
 Engine Street, allowing motorists to all
 take an hour. No stoplights... no inter-
 sections.
 "The way Ford Street will be made
 wider by the elimination of sidewalks...
 elimination of parked cars and loading
 trucks. Pedestrians will walk along and
 cross streets at the ground-level level.
 Truck loading and parking facilities will
 be underpassage..."



Take 4 miles to every 5 are Signal 4—
 the most surprising kind of driving, the
 most useful of machines. Notice with the
 average national shape 10 times a year.
 This 4 shape one made enough gasoline
 to drive one mile.



Automotive engineers call Super-Hull
 "bullet-shaped," as quickly, as easily,
 as possible to the highest standard. The
 material is of super-steel with the ease
 of stop and go. There is a Shell dealer
 near you.





This is the City of TOMORROW

*Pedestrians—
Express traffic—
Local traffic—
— each will be given
a clear path by 1960**

...predicts **NORMAN BEL GEDDIS**,
authority on future trends.

*When traffic delays and confusion seem hopeless, remember that men of vision are working on the problem. Already traffic engineers are planning city streets and country highways, lane from stop and go...

*1. Sidewalks will be elevated—you'll walk and shop ABOVE Main Street, actually cross OVER it.

*2. Local traffic will use the FULL width of the streets below—no sidewalks, no parked cars. Loading and unloading will be done INSIDE the buildings.

*3. High-speed, long-distance traffic will have its own elevated, one-way lanes, no stop lights or intersections.

**.but TODAY,
4 miles in 5 are
Stop and Go**

STOP-AND-GO driving is not only annoying, but also is the costliest kind you do.

One stop can waste enough gasoline to take you 5 city blocks... and 30 stops a day is the nation-wide average!

While traffic authorities are planning "The City of Tomorrow," Shell engineers have developed a fuel... Super-Shell... to meet today's driving problem TODAY.

They have found a way to rearrange the chemical structure of gasoline... actually to balance it. Automotive engineers term Super-Shell "motor-digestible," because at all speeds it is converted so QUICKLY, so COMPLETELY into power.

Save by the regular use of Super-Shell. A Shell dealer is near you.

SUPER-SHELL 



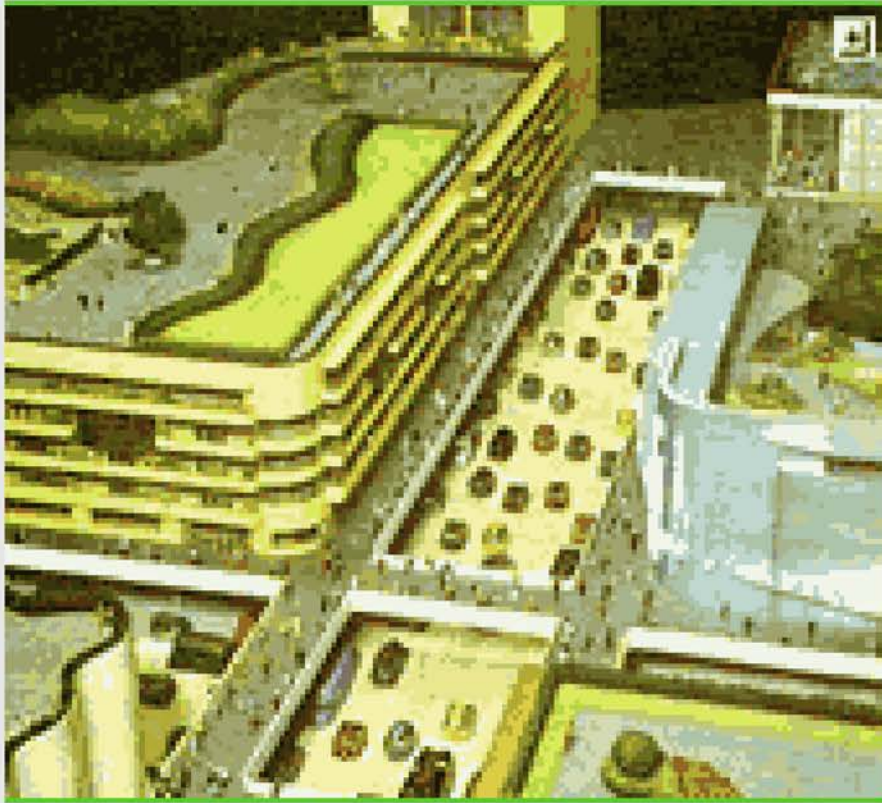

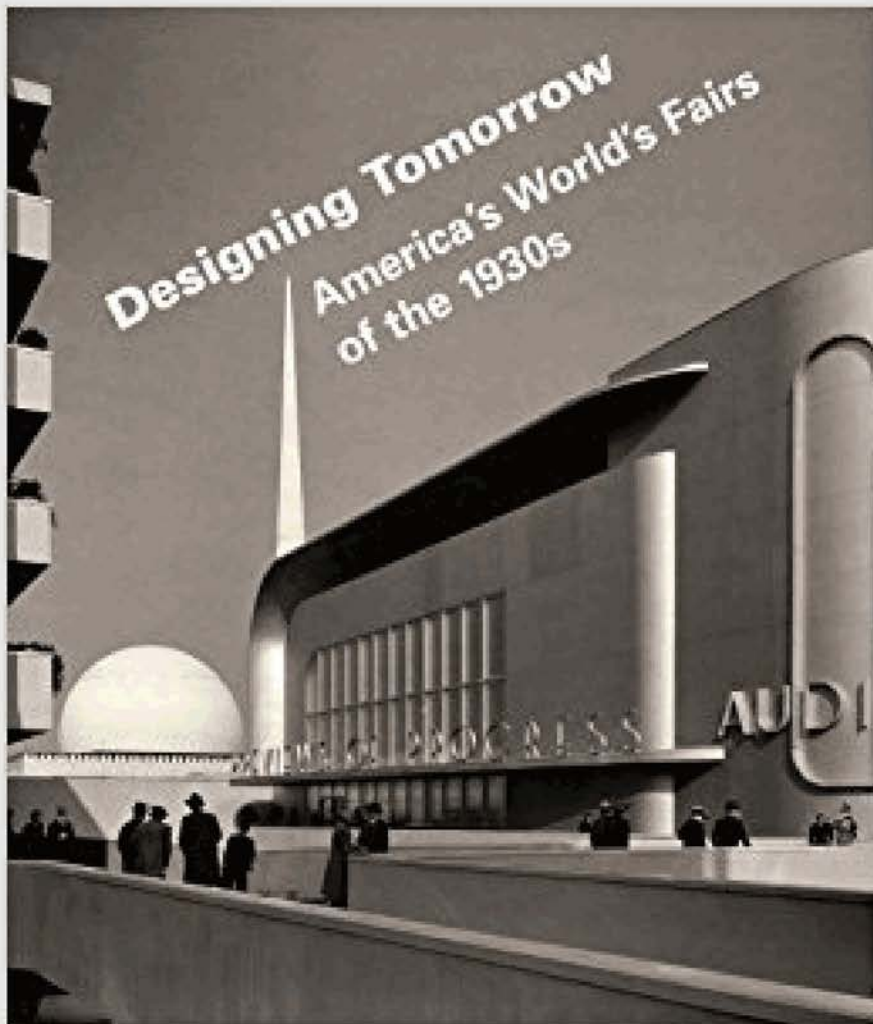

ИНТЕРЬЕРЫ И ВЫСТАВКИ



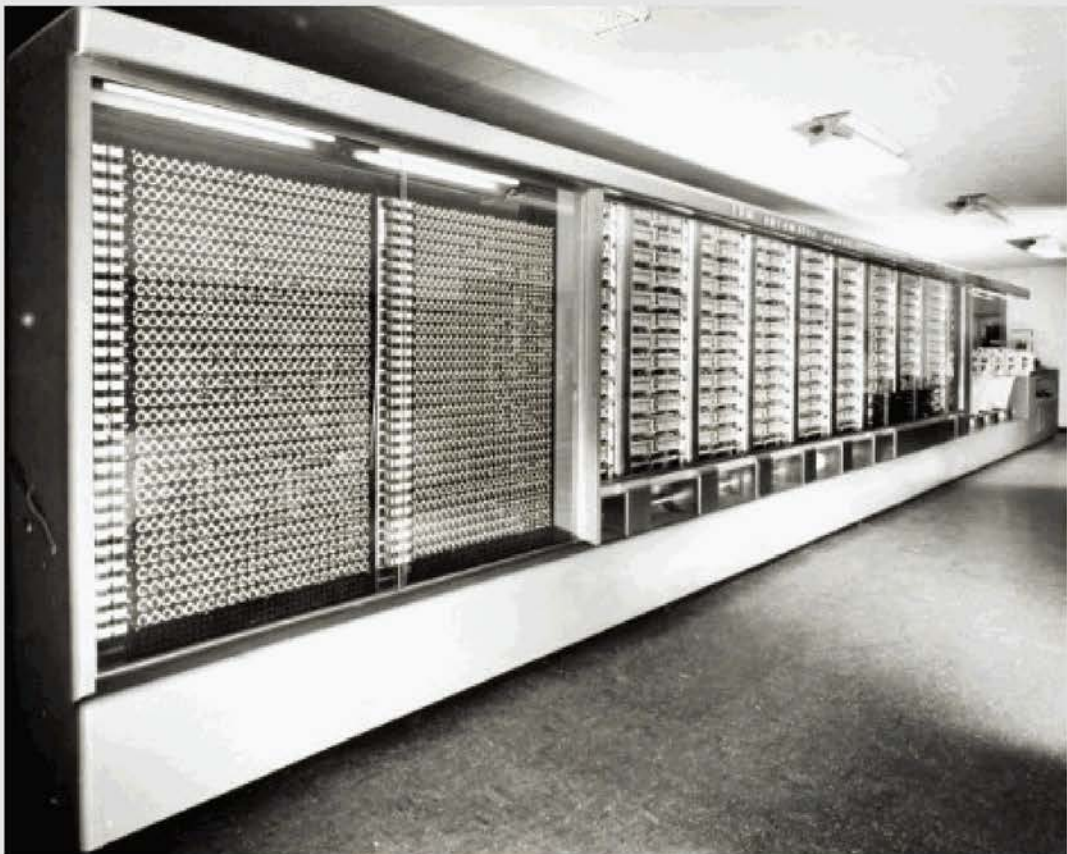

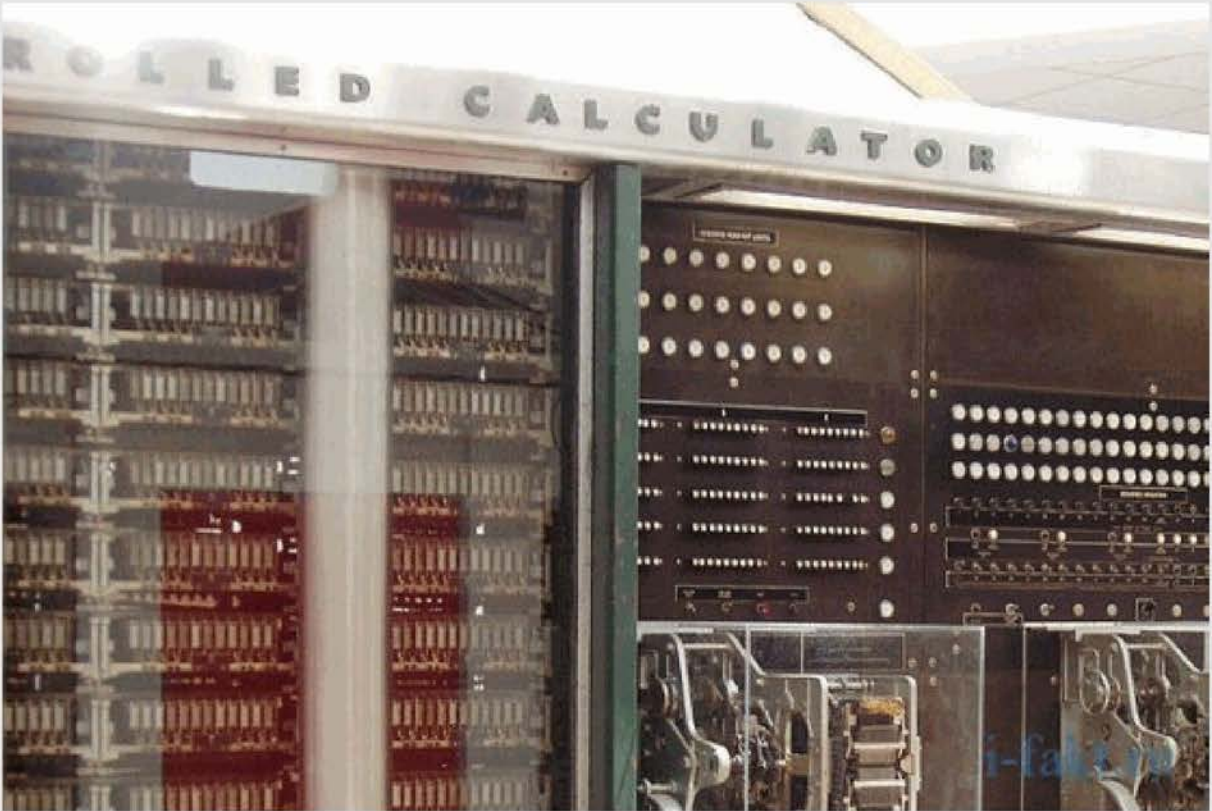

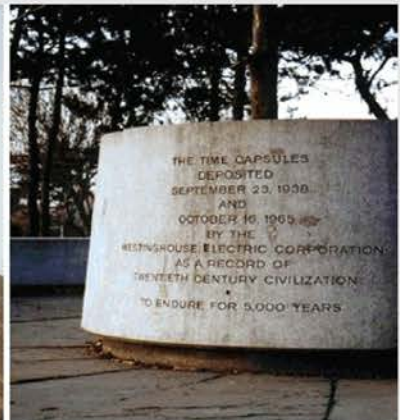
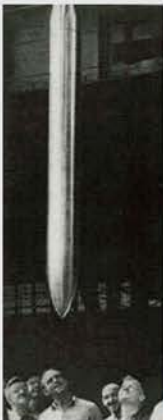
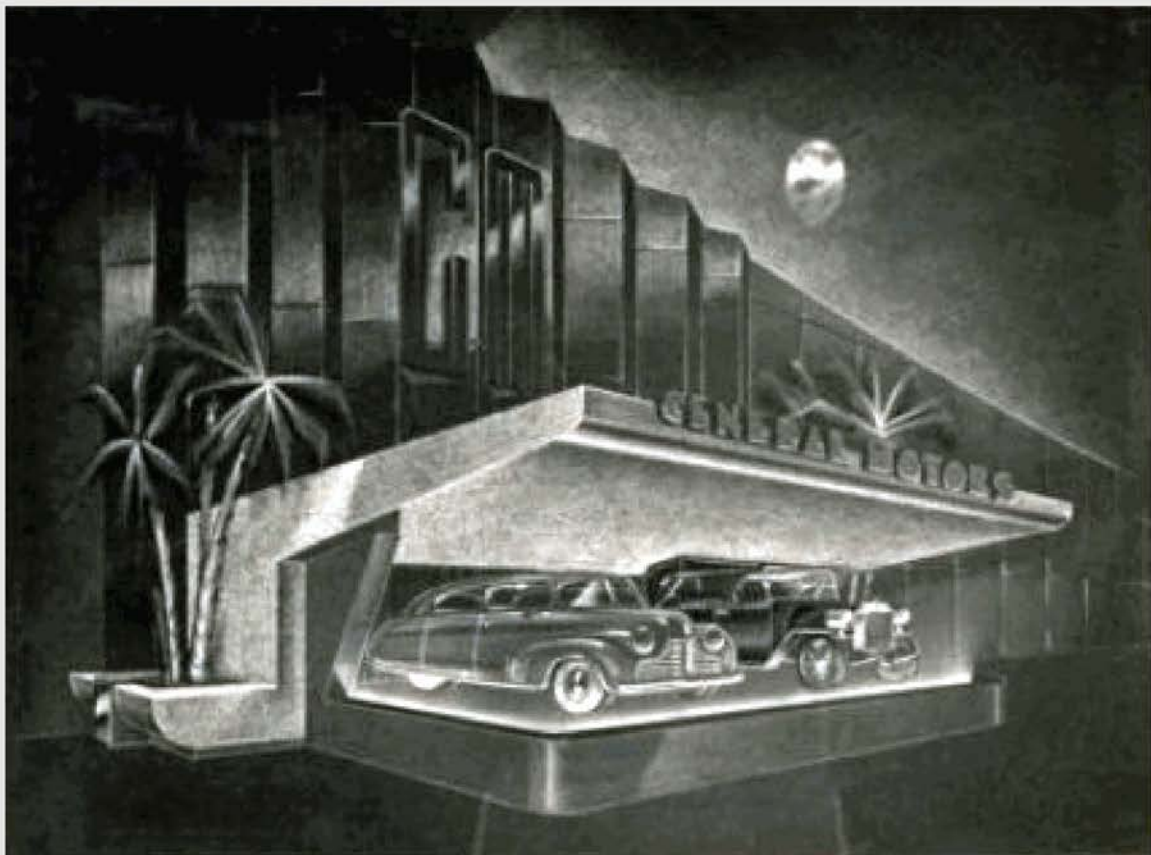
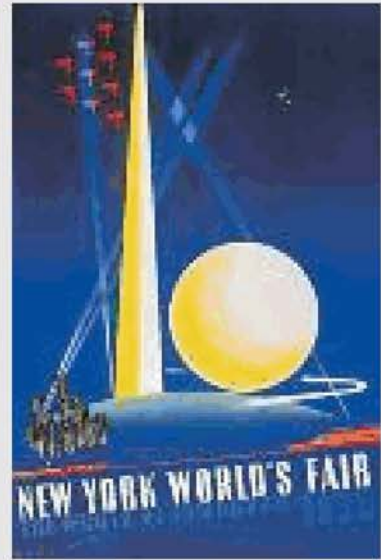
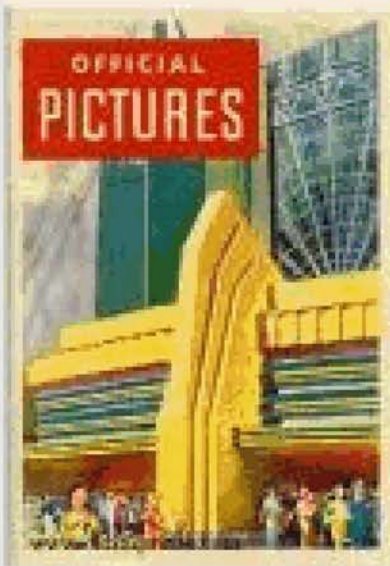



АВТОМОБИЛИ

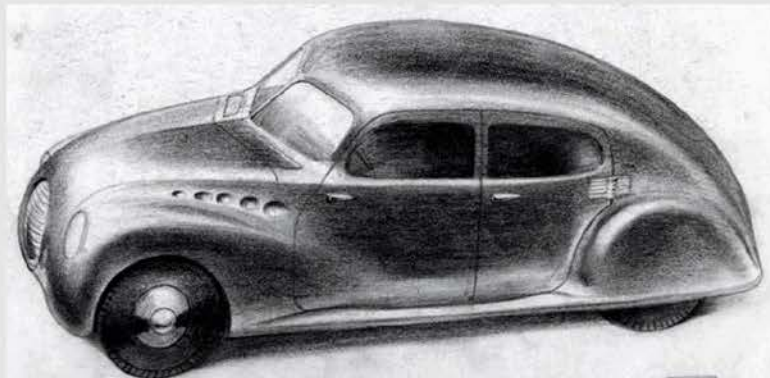

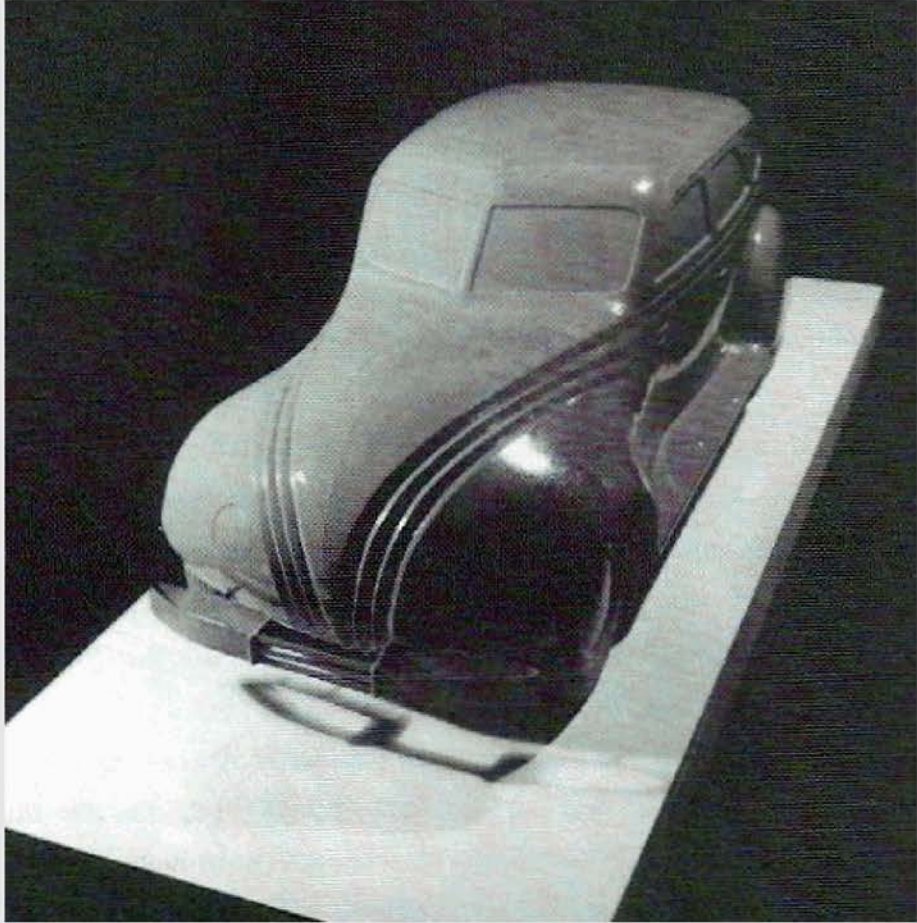
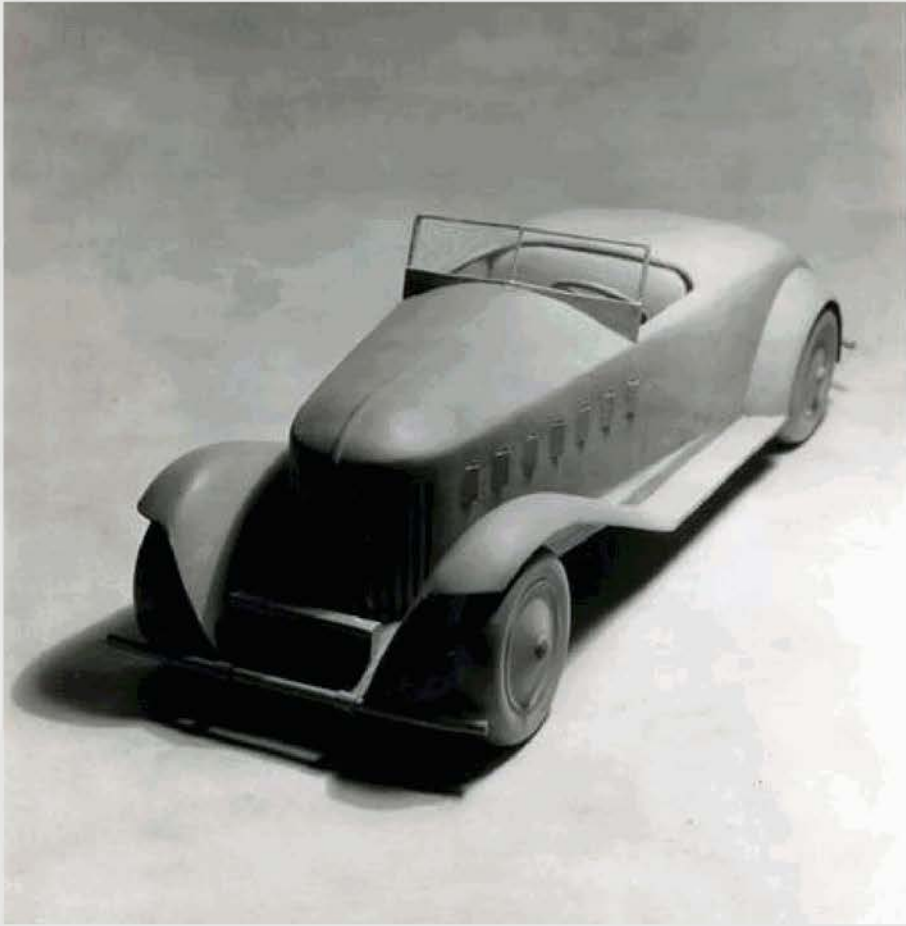



The Automobiles of Norman Bel Geddes

continued

Airflow did lag, Chrysler put the Airstreams into production and still turned profits during the years of slow Airflow sales. Ray Dietrich also provided the facelifts for the 1936-37 Airflows.

Thus Geddes's dealings with Chrysler really came to nothing. And one odd thing about them is that he (Geddes) code-named Chrysler Corp. as the "Q Organization." He referred to Walter P. Chrysler, who sat in on several Geddes meetings, as "Mr. Q," and to W.P. Chrysler Jr. as "Mr. Q Jr." Geddes insisted that his entire staff also call Chrysler "Q." He even made some of his designers sign pledges of secrecy. Yet Geddes's own memos made it clear that Q meant Chrysler. He liked to play such games; often

talked about industrial spies and spying, sometimes firing staff people when he—rightly or wrongly—suspected subterfuge.

Geddes's third "Q" assignment had been to design a not-too-radical Plymouth Airflow, coded P-113. While that project got as far as a full-sized clay, it never went into metal. Geddes did both exteriors and interiors for the P-113.

AFTER HIS Q CONTRACT expired, Geddes was hired in 1935 by Autocar to style its large truck line. This work went smoothly, although details of the job are scant. The idea was to make Autocar trucks look more powerful through a massive front-end ensemble; also to modernize the cab for more sales appeal.

In 1937, Geddes approached Shell Oil with an idea for "highways of the future," his theme centering on city traffic problems



APR 1937 NASH PRESIDENTS STYLING ROOMS

Geddes became a consultant to Nash in 1940. These are revampings intended for 1942 production. Chief engineer Wahlberg gave Geddes a very hard time and eventually overrode all of Geddes's designs.

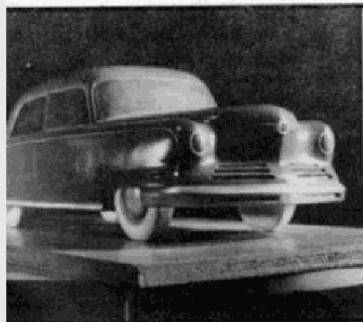
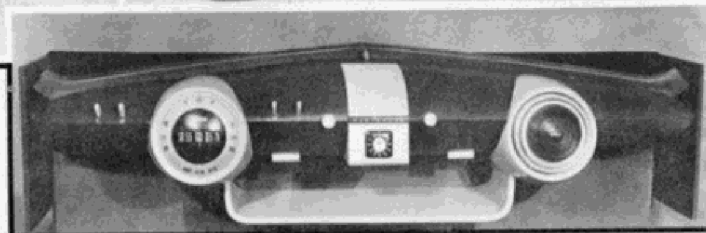

Geddes worked out a smaller Nash 600 and went along with slab-sided bodies, the same as other designers of that time. Whether semi-enclosed front wheels influenced 1949 Nash isn't recorded. Geddes's contract with Nash expired in 1942.

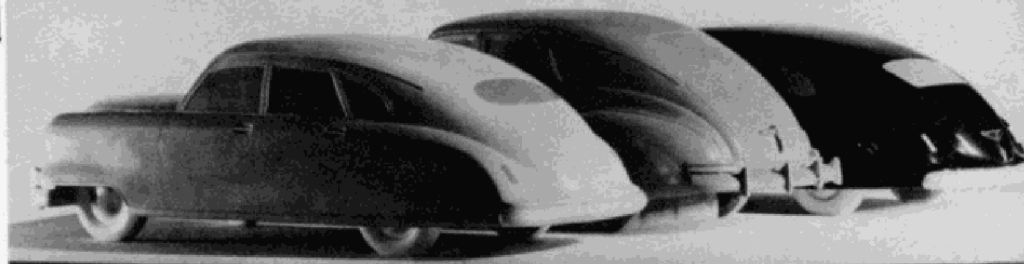

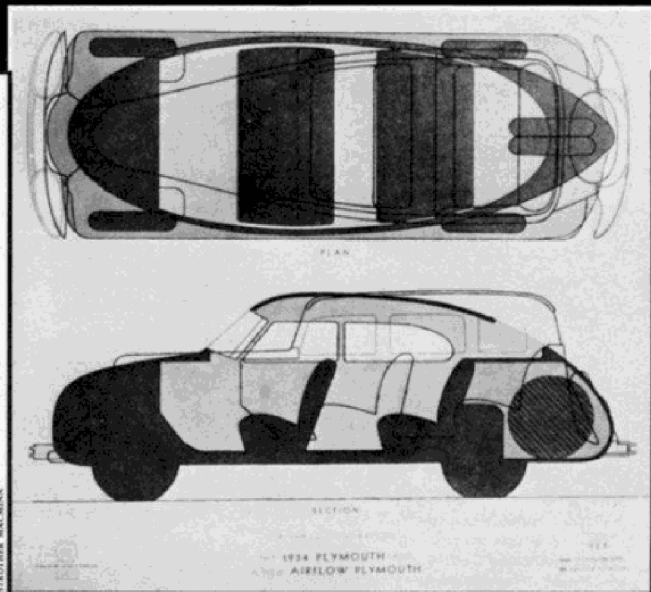
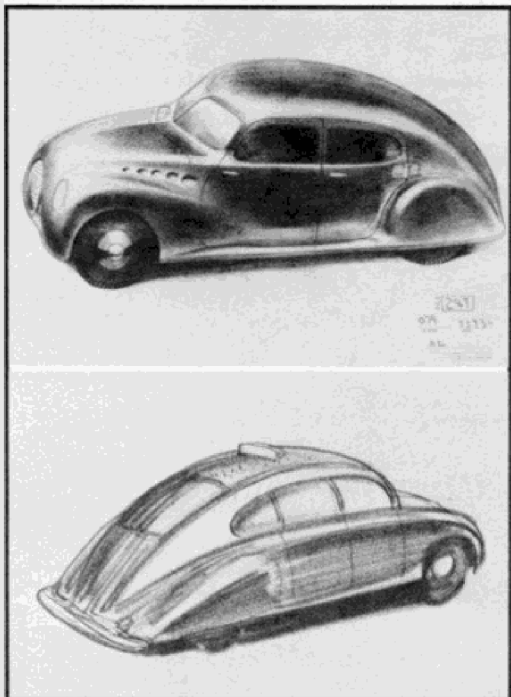

FREDERICK MACKENZIE

Above: At the request of Chrysler Corp., Geddes did proposals for a Plymouth Airflow. Left: Geddes's design firm also did a great number of drawings for more graceful Chrysler and DeSoto Airflows; two are shown here.





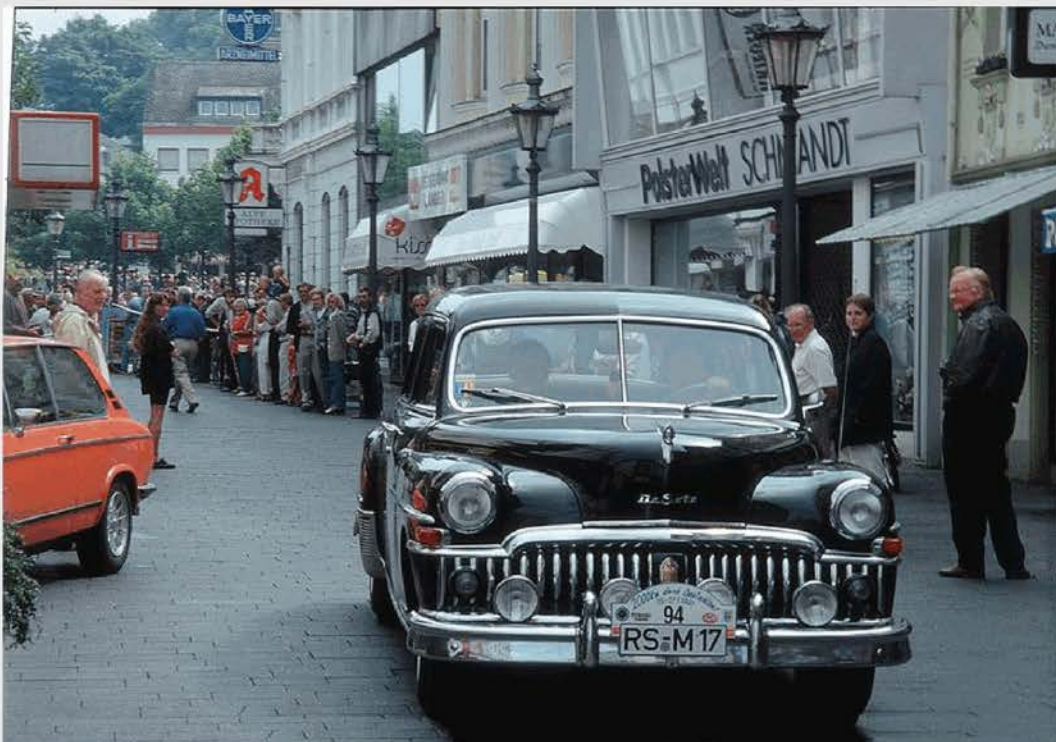

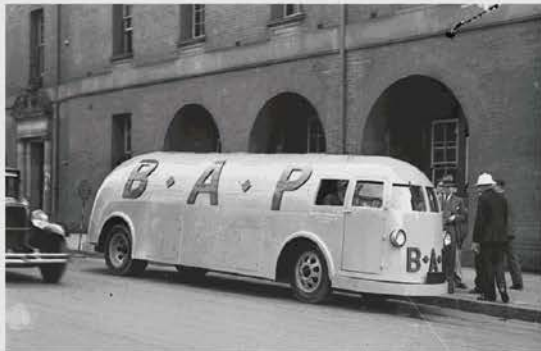



ЖЕЛЕЗНАЯ ДОРОГА



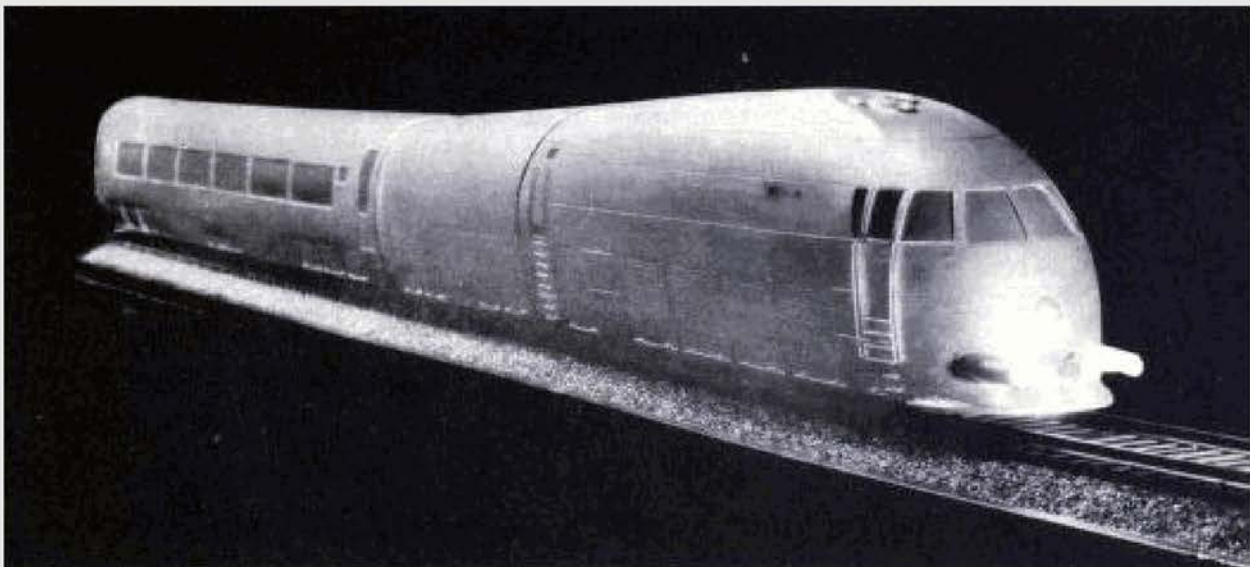
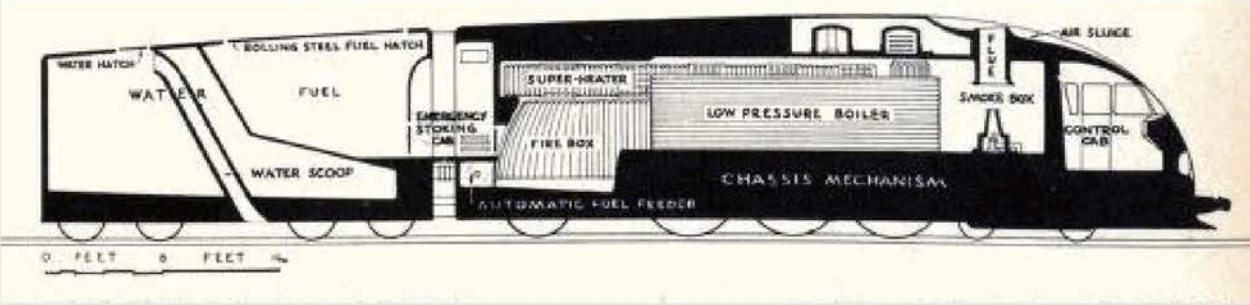
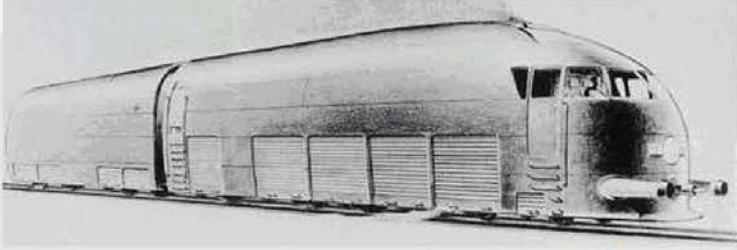
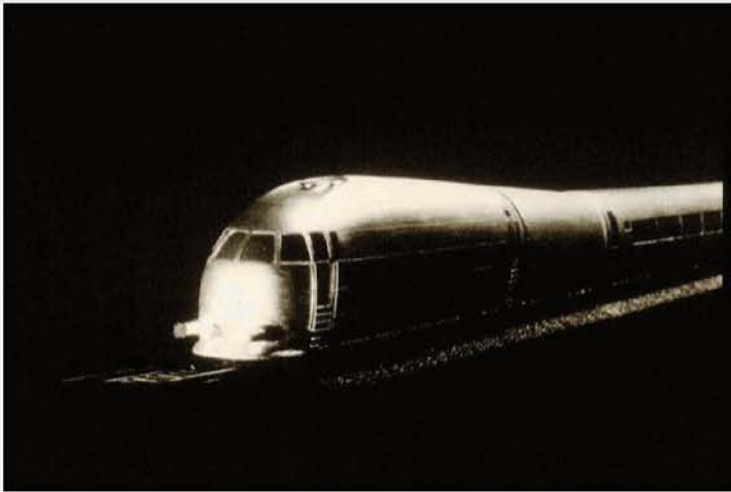

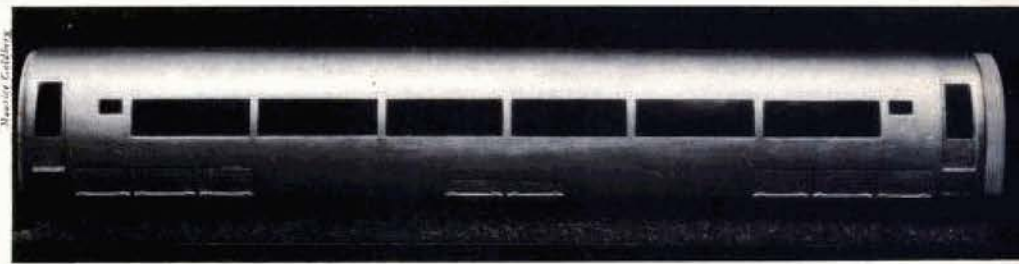
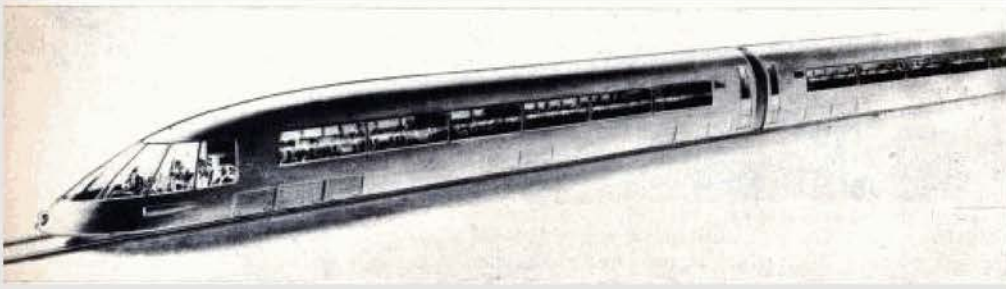

ФУТУРИСТИЧЕСКИЕ ПРОЕКТЫ



In 13 Stunden von Hamburg nach New York. Das Riesenflugboot, mit einer 100000-PS Leistung von nur insgesamt 12 Motoren, soll in Zukunft in dieser kurzen Zeit den Atlantischen Ozean überqueren

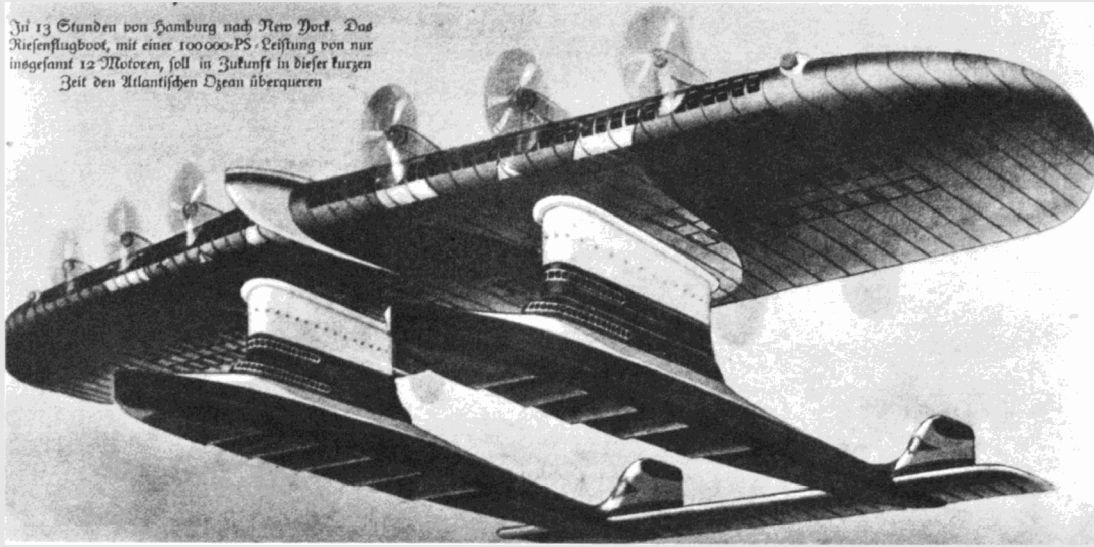

Querschnitt durch das 7-stöckige Riesenflugboot

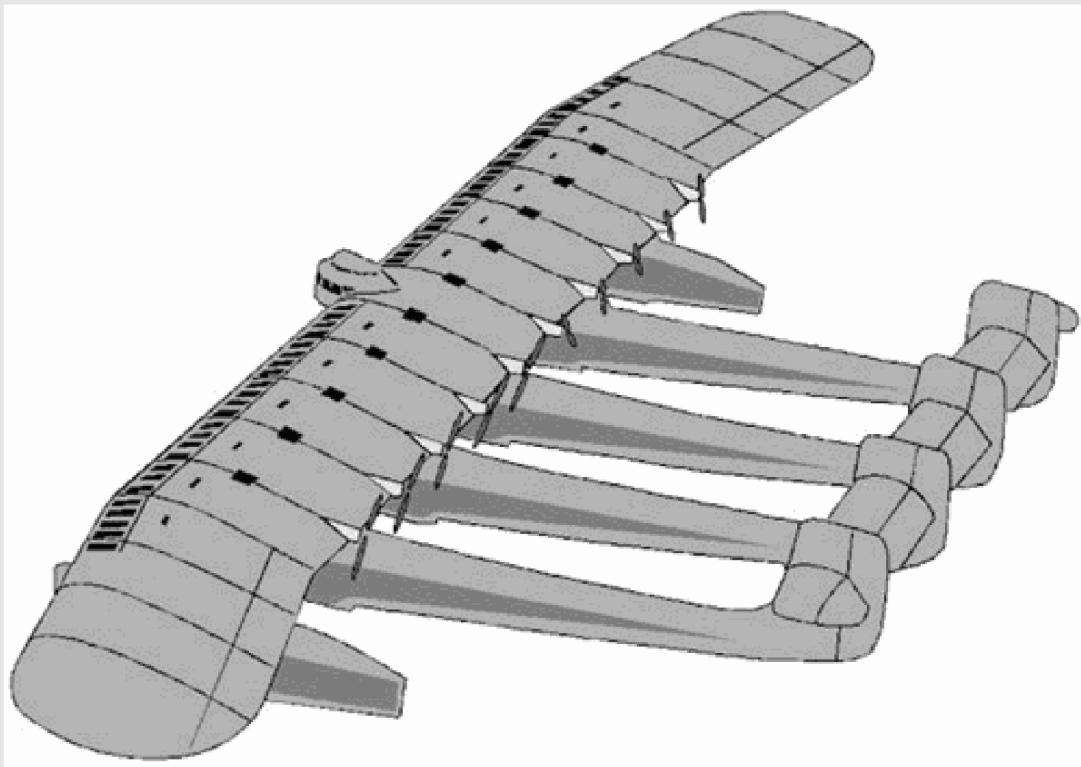
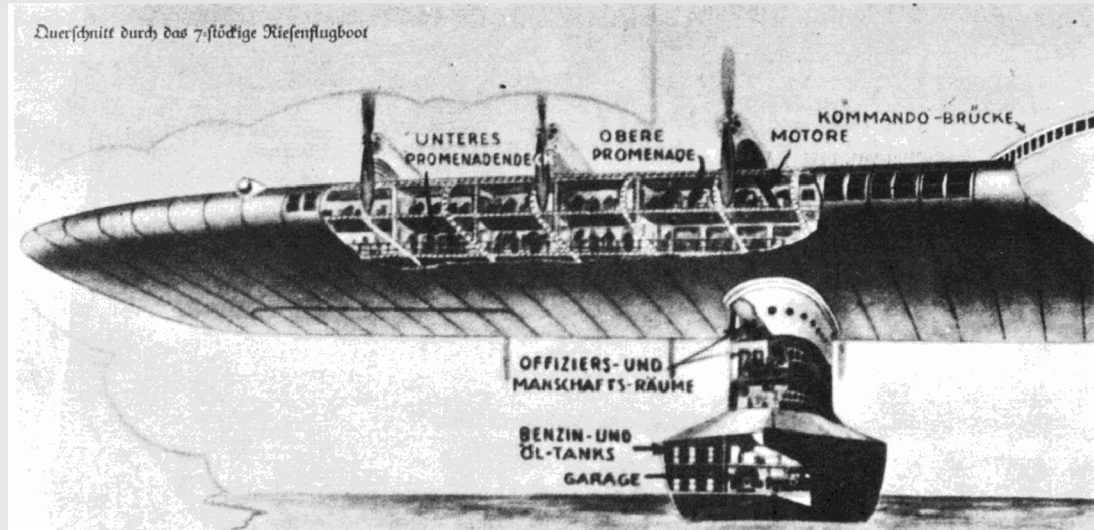

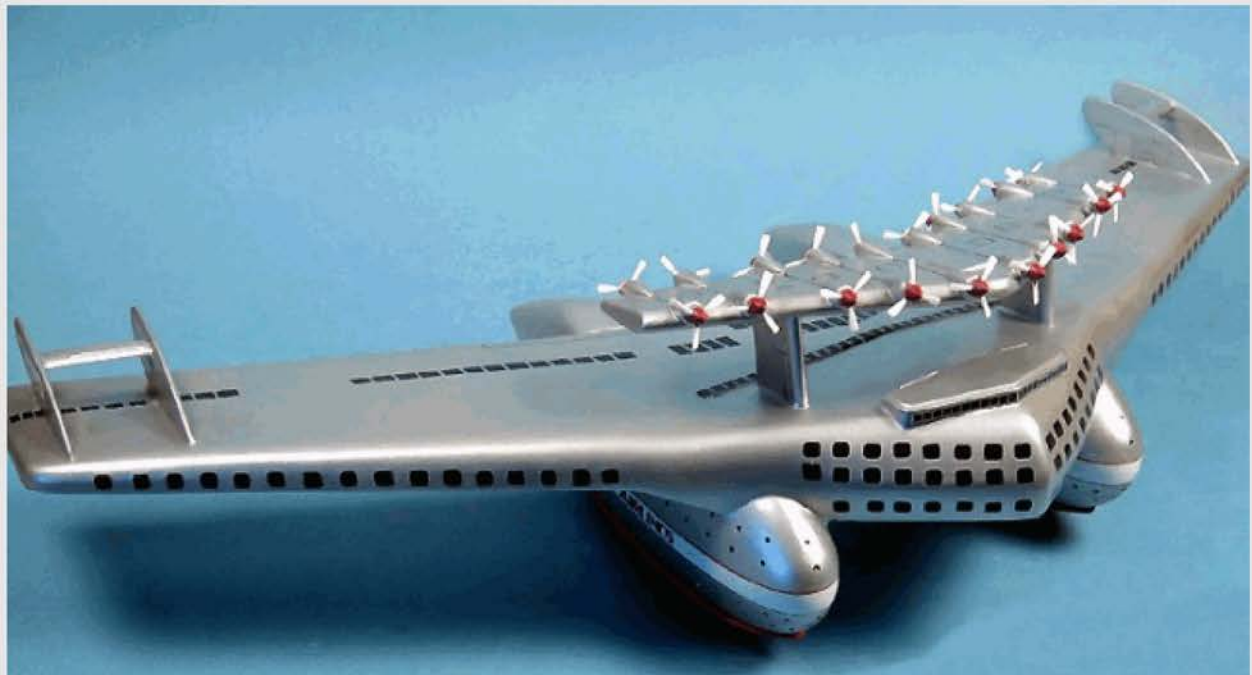
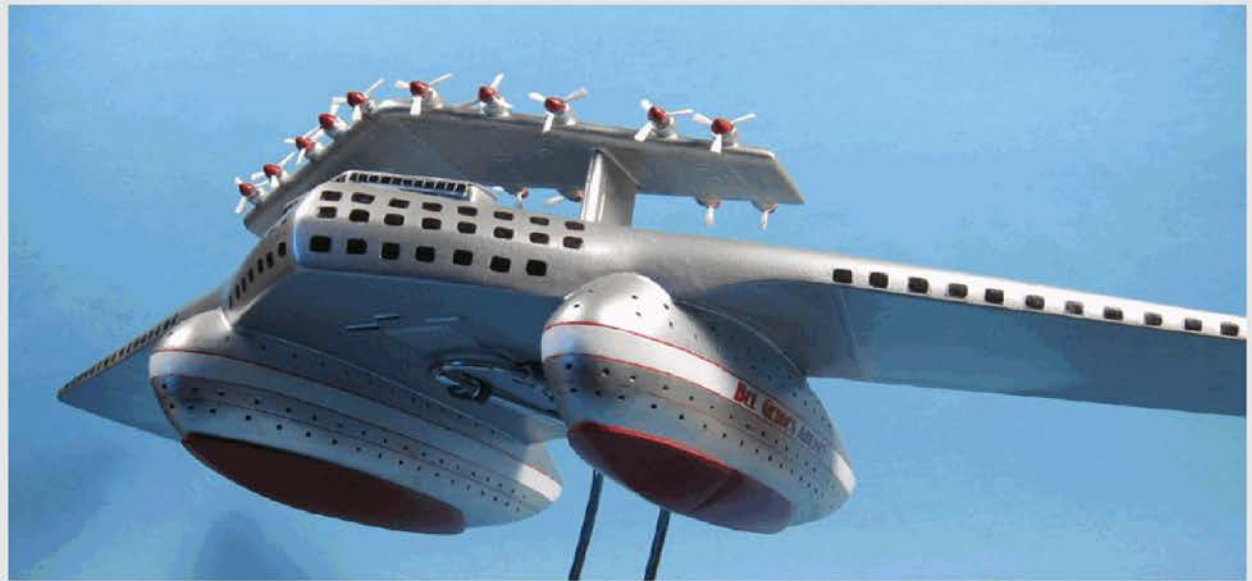
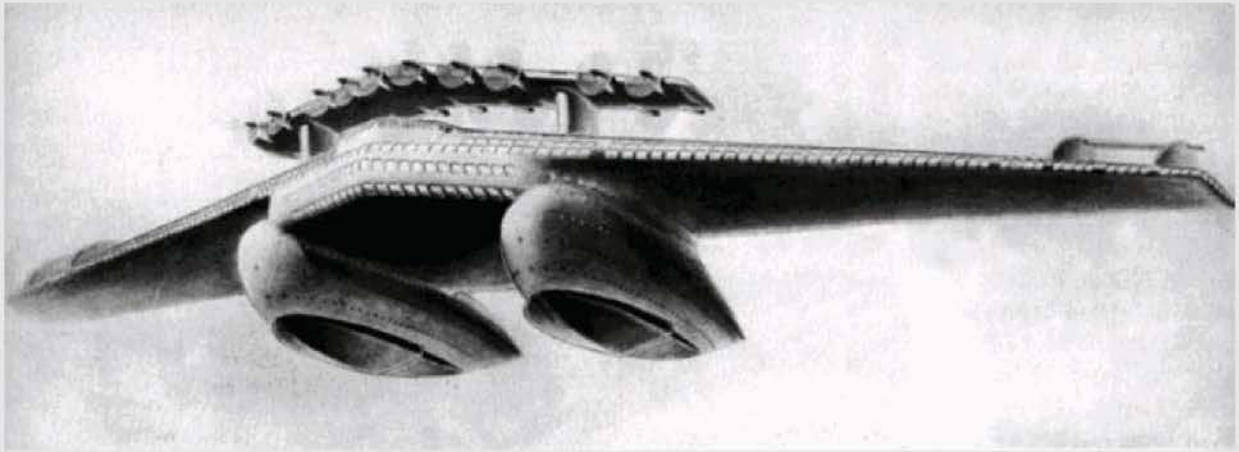



**FANTASTIC
PLASTIC**

TM

BEL GEDDES AIRLINER #4

www.fantastic-plastic.com

1:288 Scale

- * 38 Pieces
- * Huge 22" Wingspan
- * Rotocast Body, Wings and Pontoons
- * Pattern by Marc King
- * Cast by Acme Design
- * Decals by Mana Studios



**An All-Resin Hobby Kit for Moderate to Experienced Modelers
Not Recommended for Children Under 14 - Contains Small Pieces**

(c) 2009 by Fantastic Plastic Models

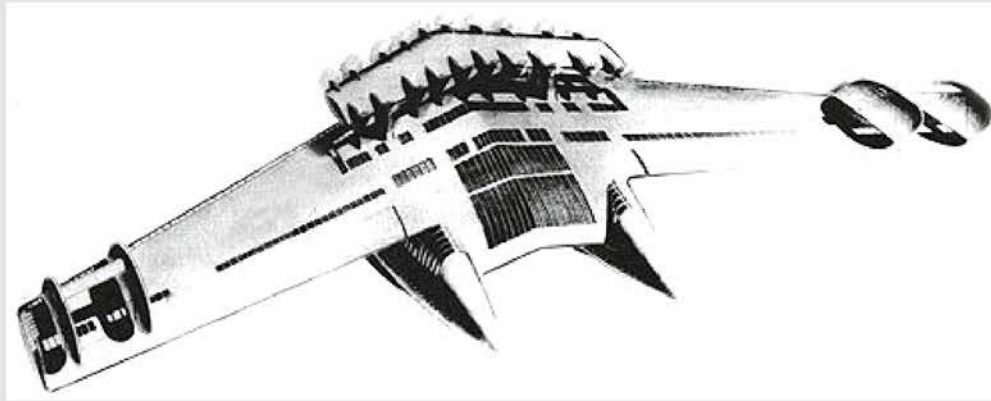

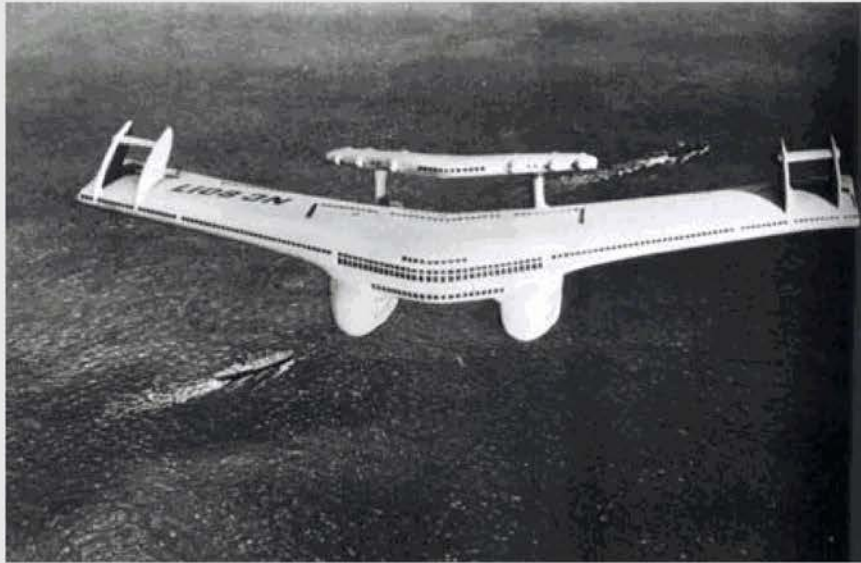

AMERICA'S FINEST LUXURY AIR LINER
Your American Hotel Aboard
35 DAY VACATION CRUISES • CALIFORNIA TO THE ORIENT



SAN FRANCISCO • LOS ANGELES • NEW YORK • CLEVELAND • BOSTON • WASHINGTON, D.C. 

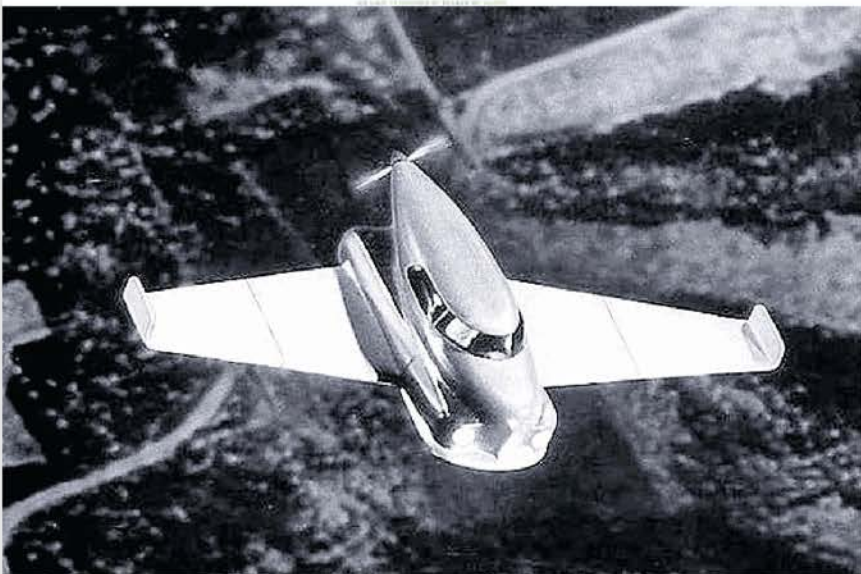

ФУТУРО АВТОМОБИЛИ



I HAVE SEEN
THE FUTURE

NORMAN
BEL GEDDES
DESIGNS
AMERICA



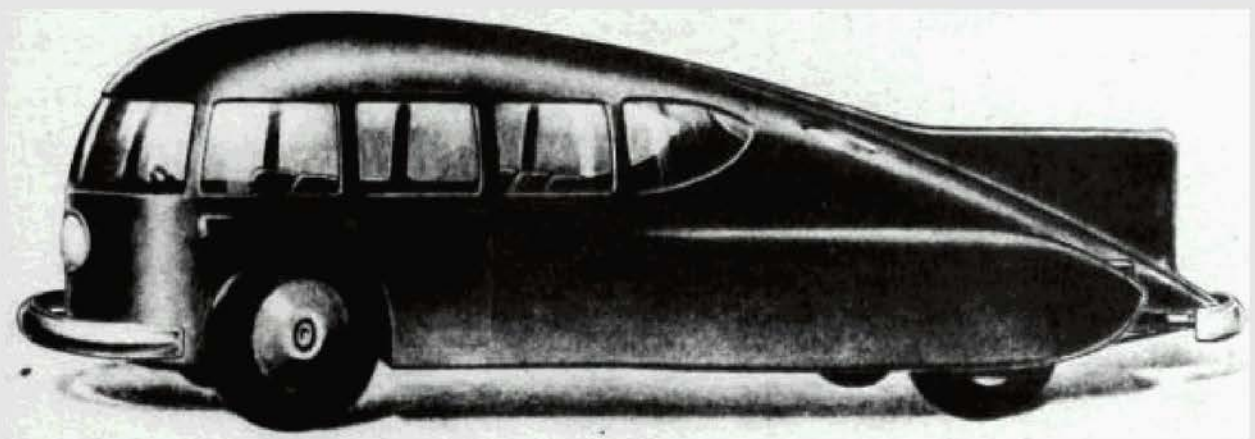
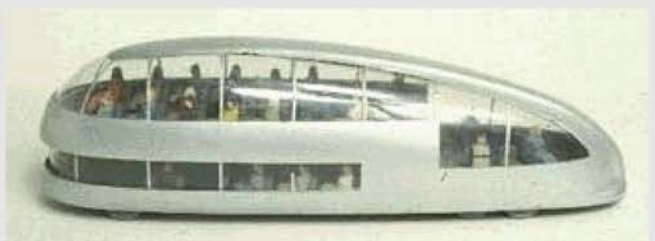
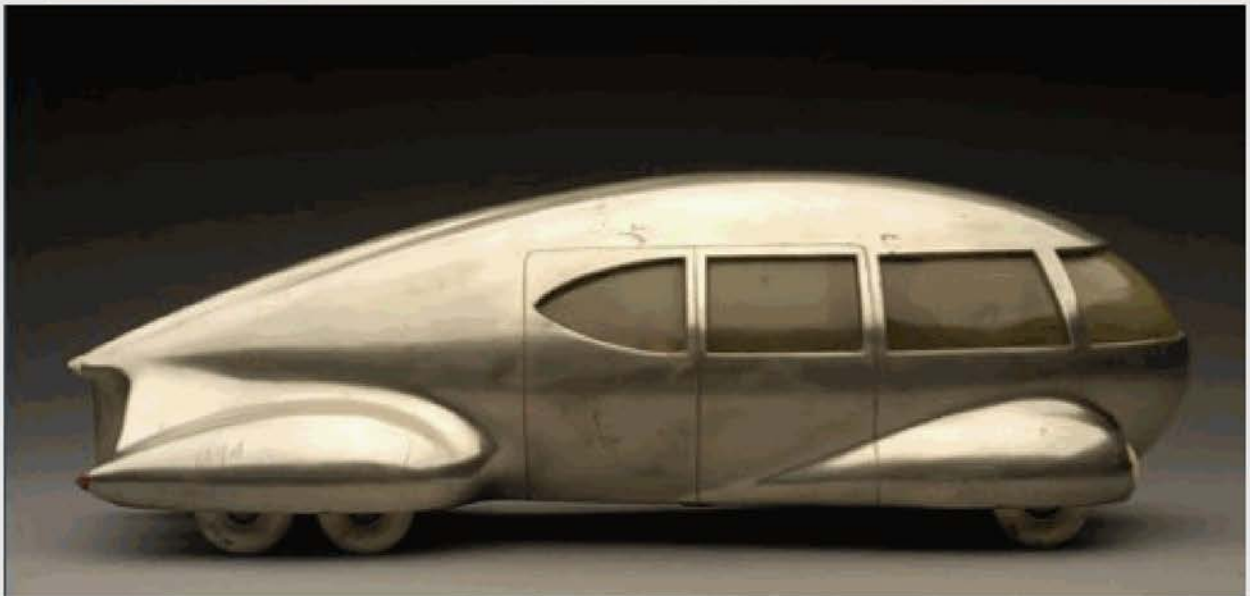

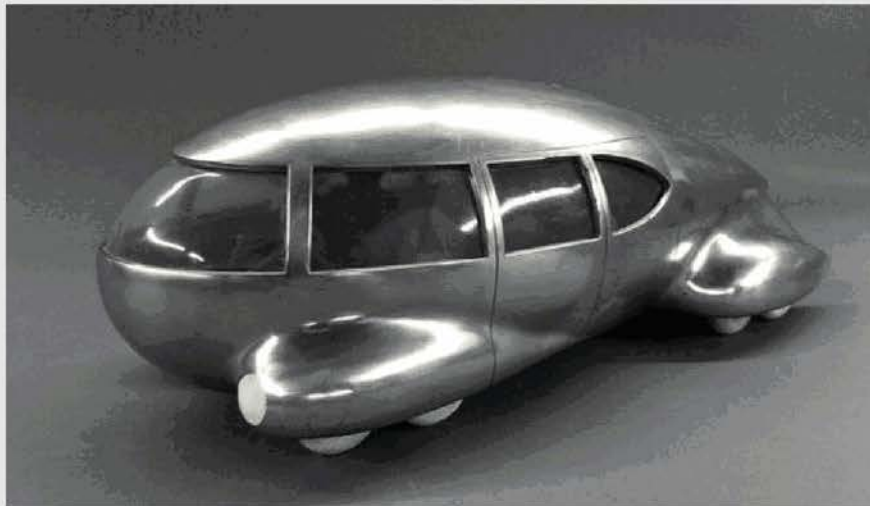

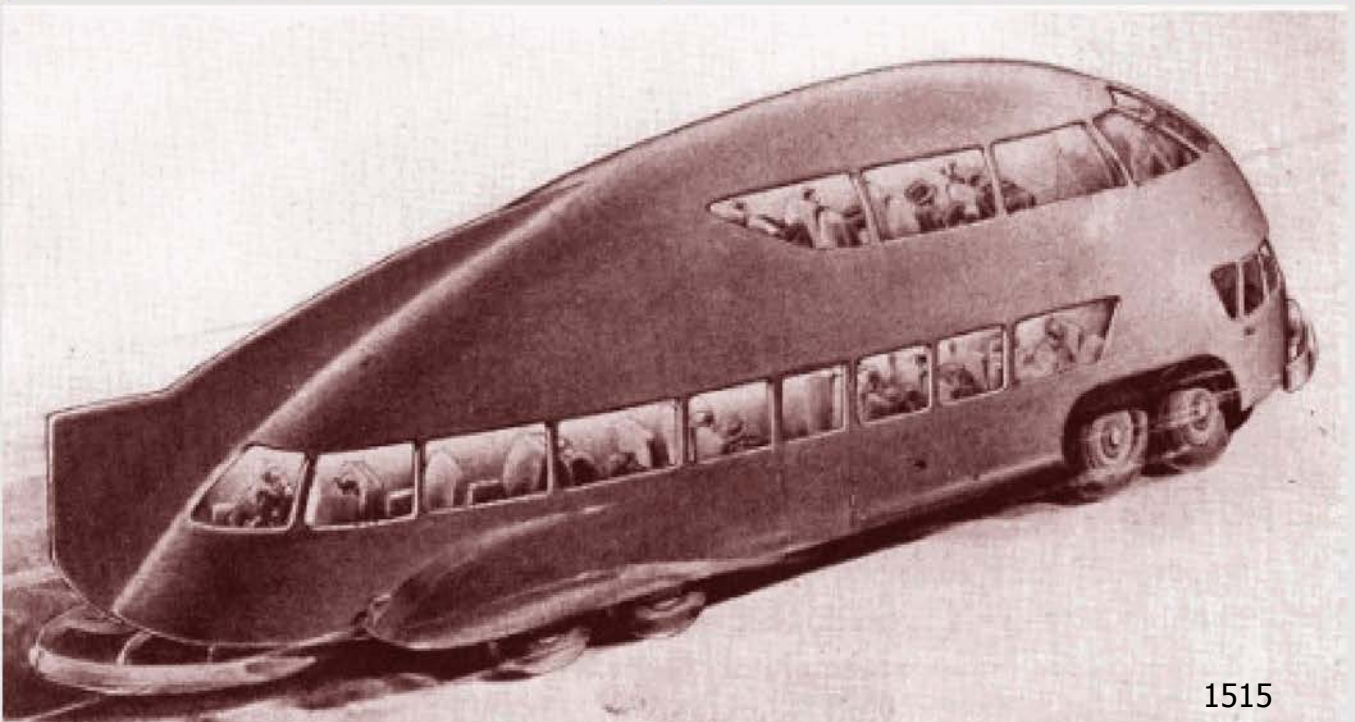
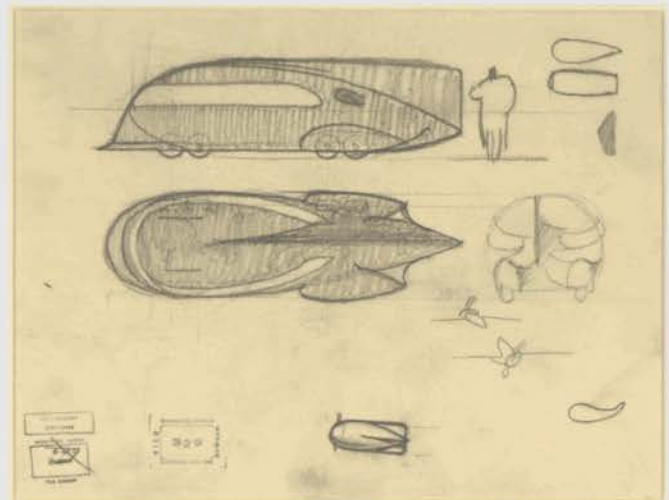
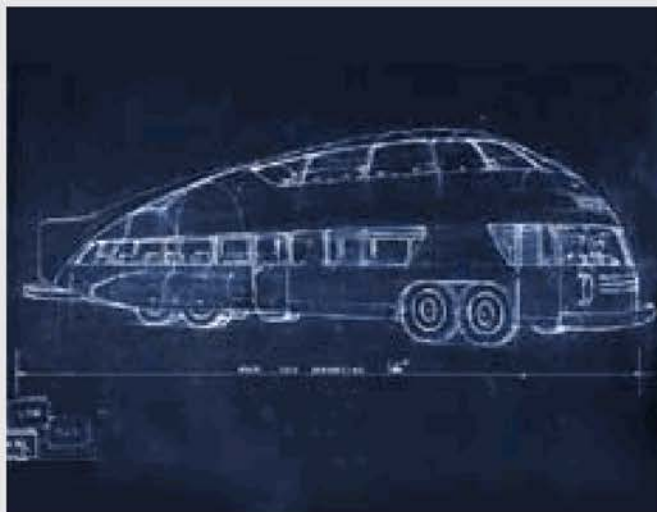
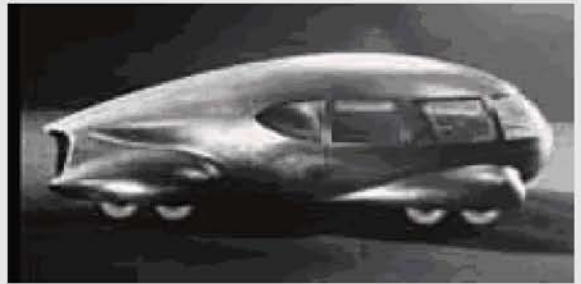

КОРАБЛИ И ЛОДКИ

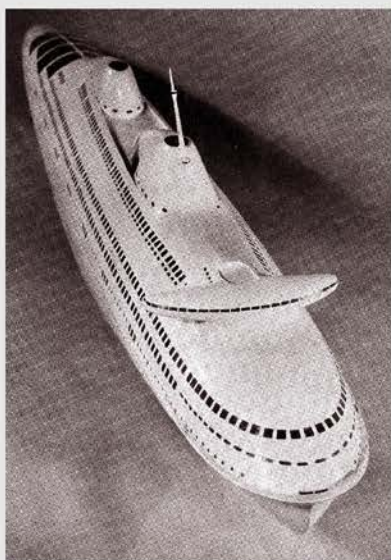



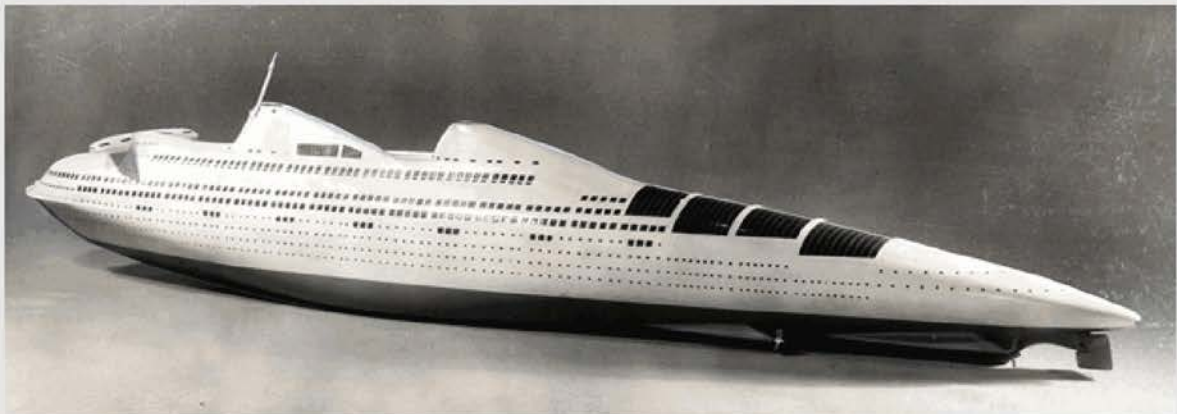
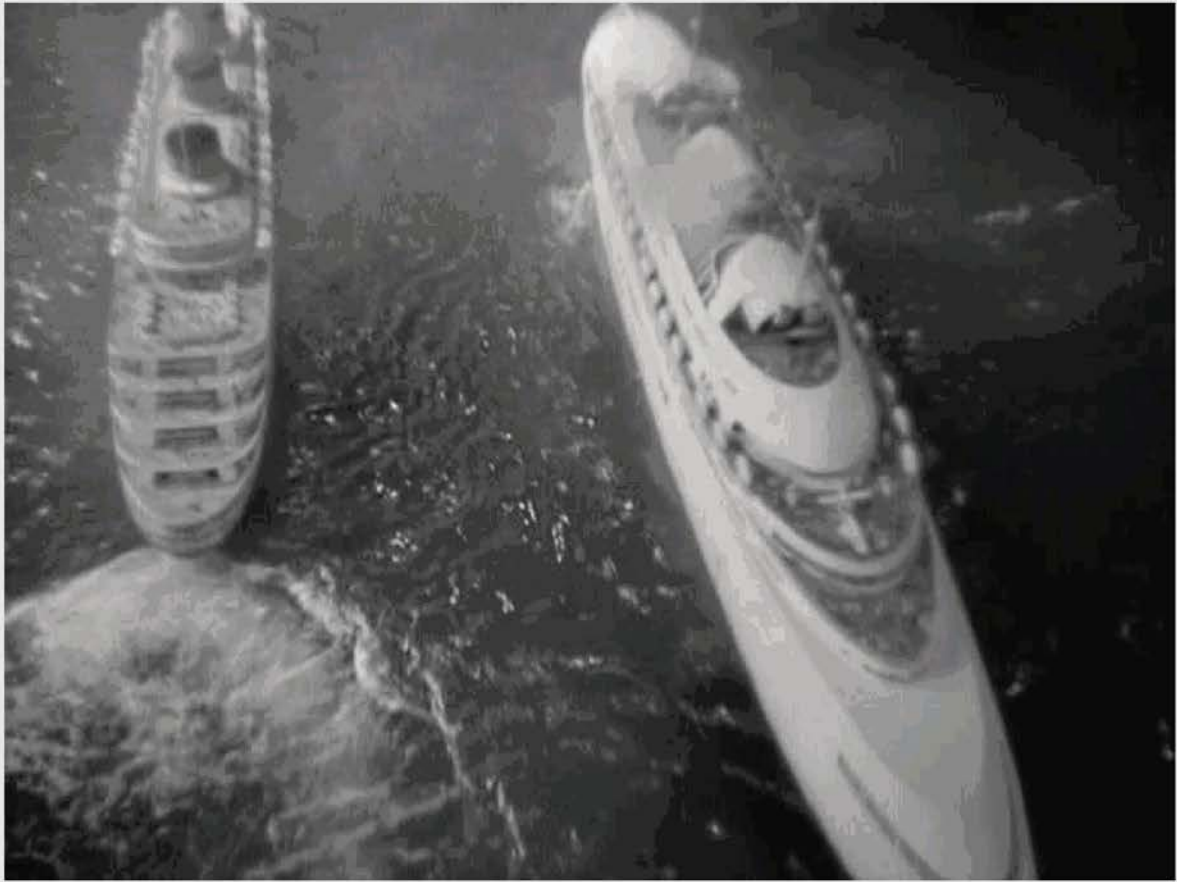

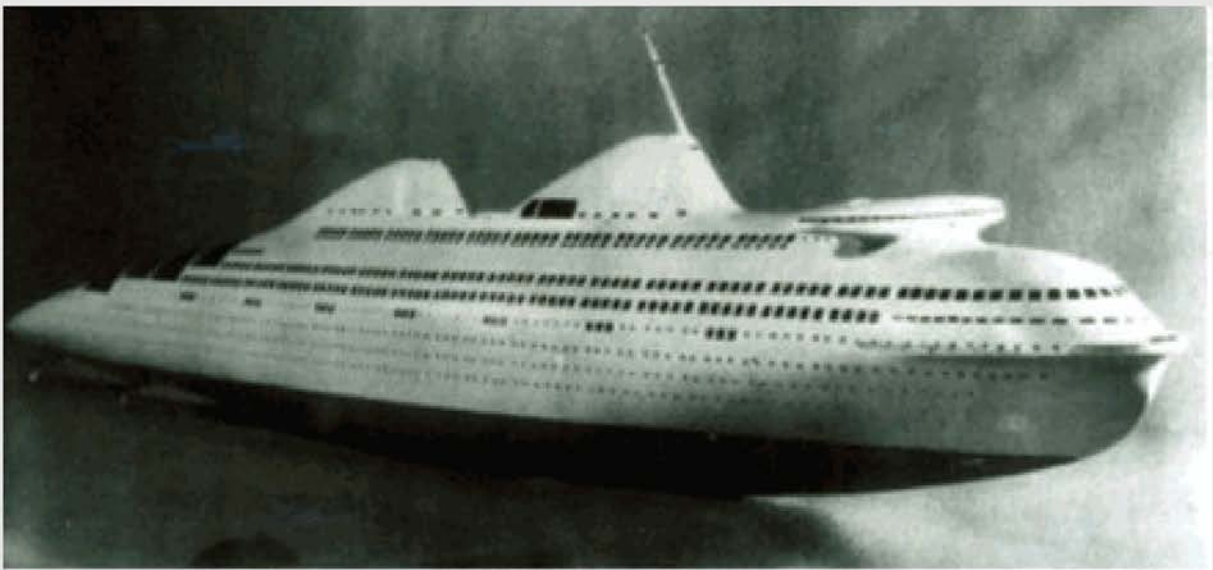

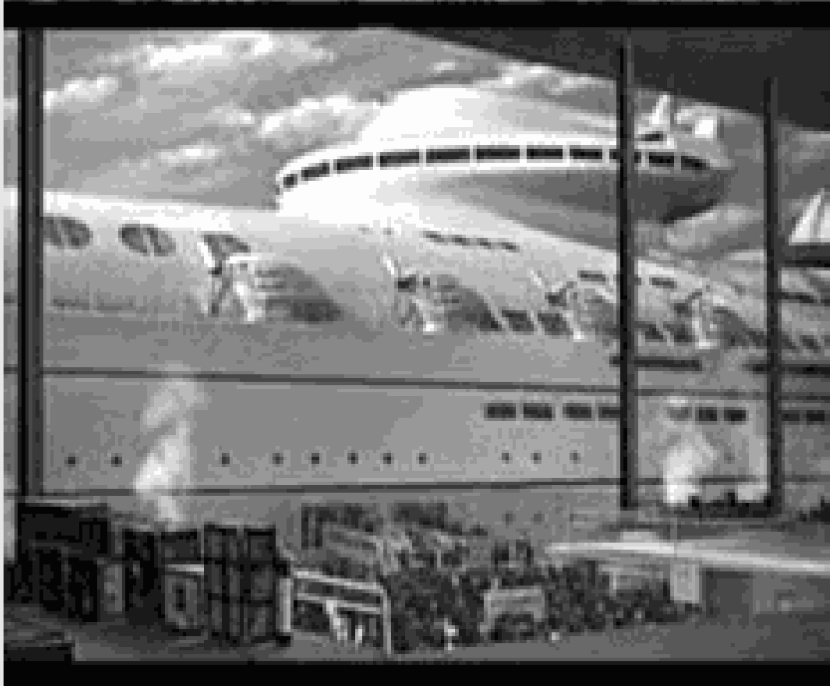
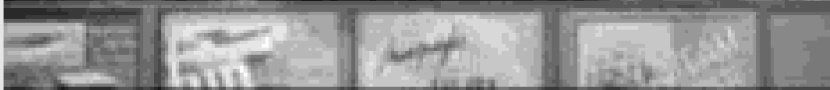



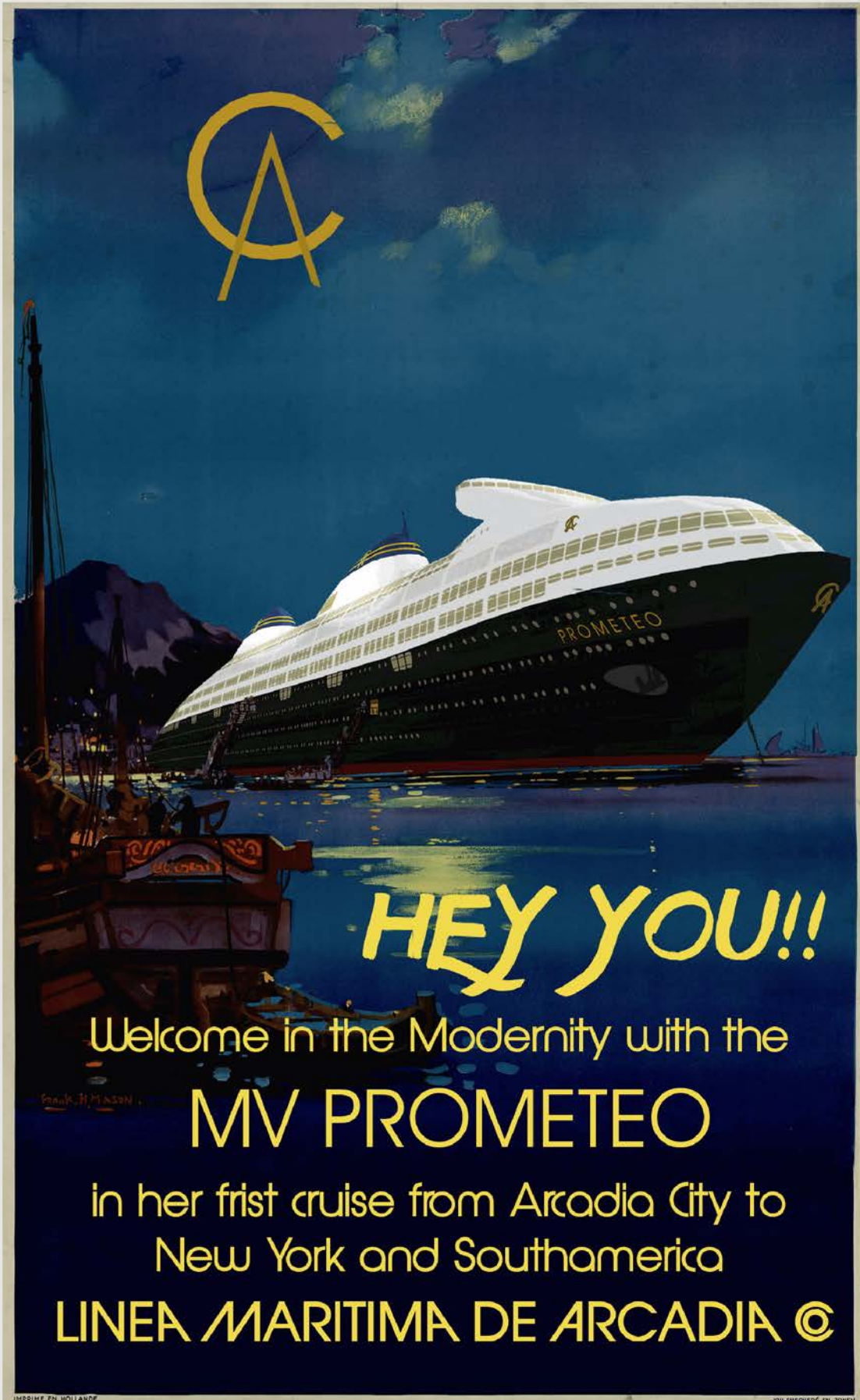

HEY YOU!!

Welcome in the Modernity with the

MV PROMETEO

in her frist cruise from Arcadia City to
New York and Southamerica

LINEA MARITIMA DE ARCADIA ©

IMPRIME EN HOLLANDE

JON ENSCHEDÉ EN ZONEN

July 16, 1935.

N. B. GEDDES
SHIP

Dec. 96,244

Filed Dec. 3, 1934

2 Sheets-Sheet 1

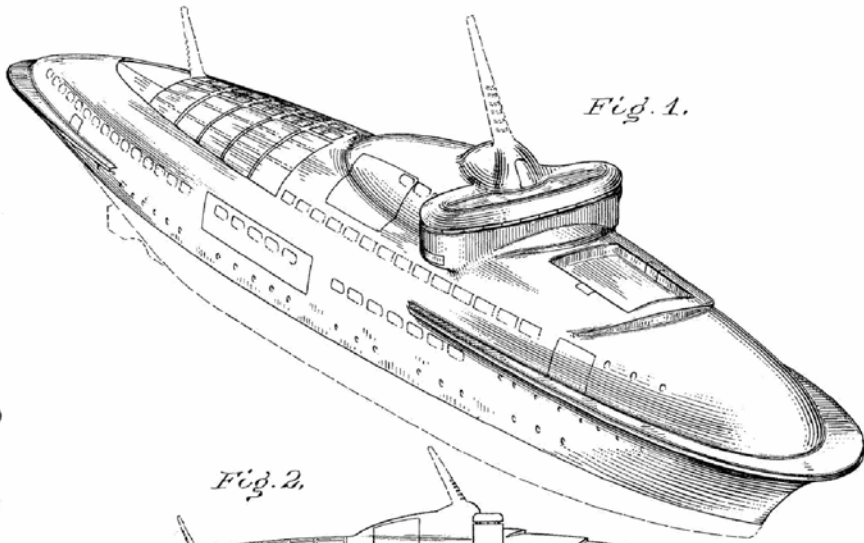

Fig. 1.

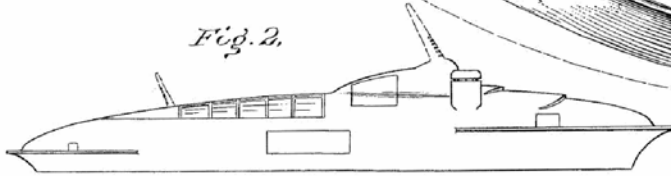

Fig. 2.

INVENTOR:
Norman Bal Goddas
BY
Morrison, Kinsedy & Campbell
ATTORNEYS.

July 16, 1935.

N. B. GEDDES
SHIP

Dec. 96,244

Filed Dec. 3, 1934

2 Sheets-Sheet 2

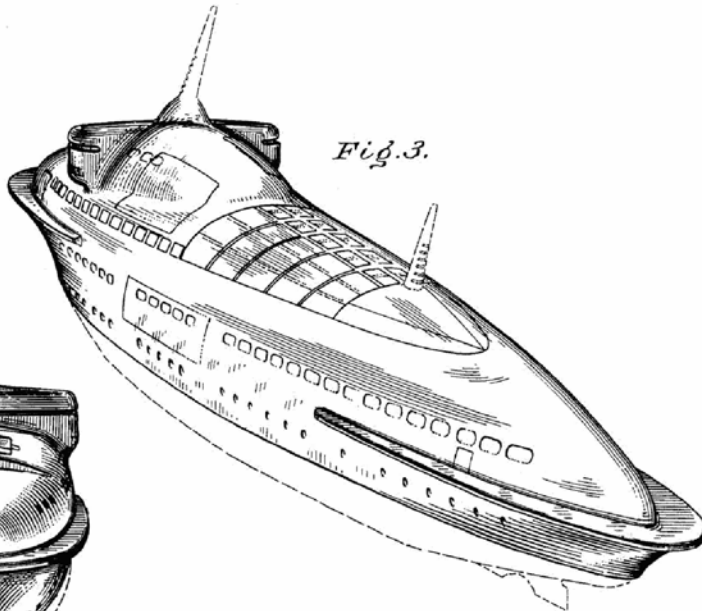

Fig. 3.

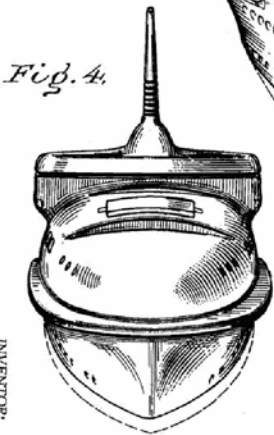
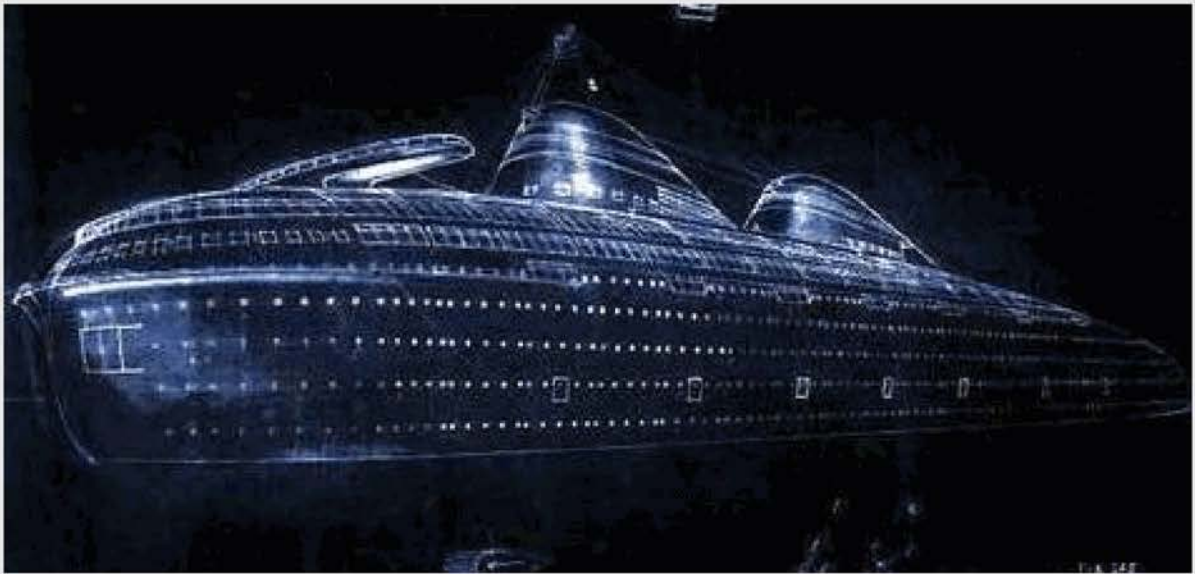
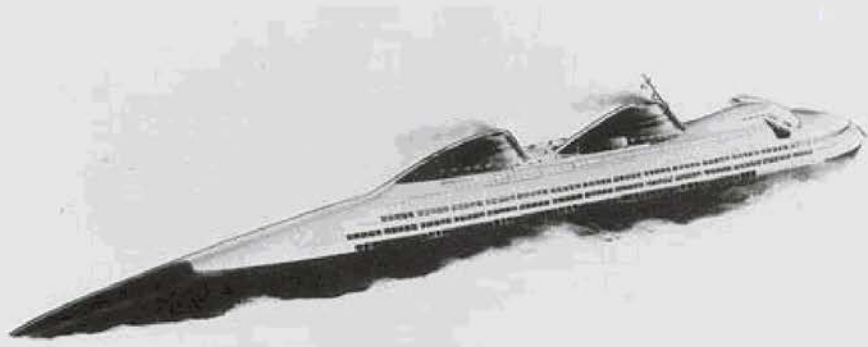

Fig. 4.

INVENTOR:
Norman Bal Goddas
BY
Morrison, Kinsedy & Campbell
ATTORNEYS.





ПОСУДА



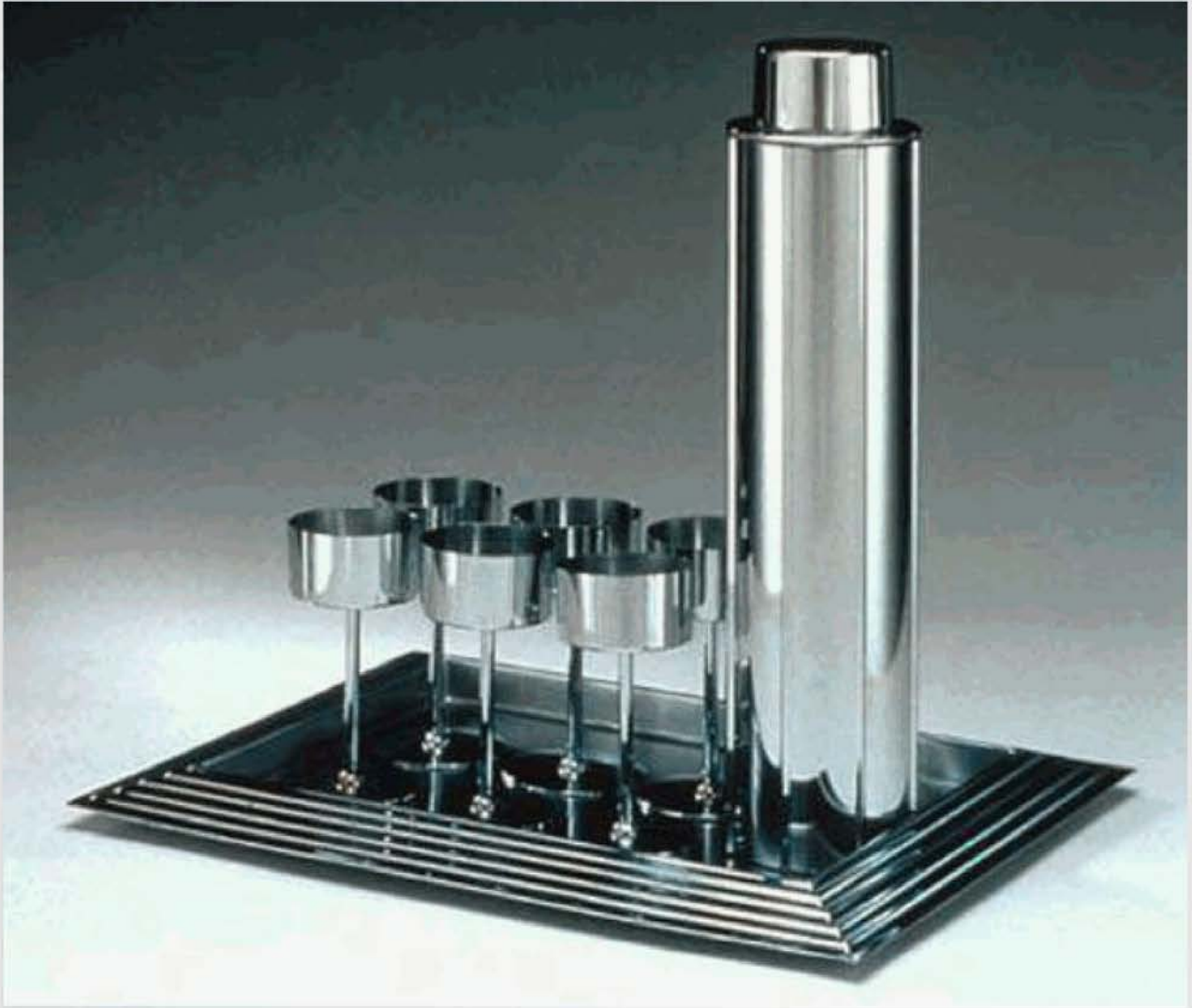















РАДИО



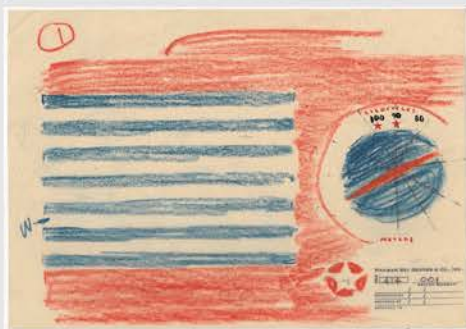













ЛАМПЫ







ПЫЛЕСОСЫ

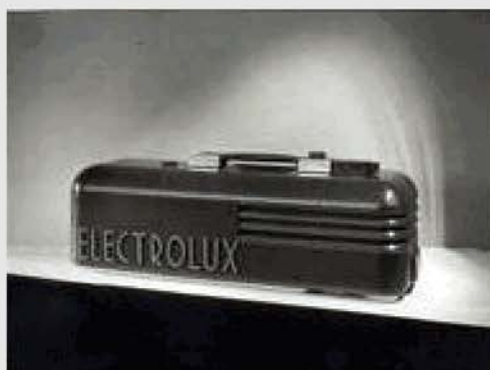

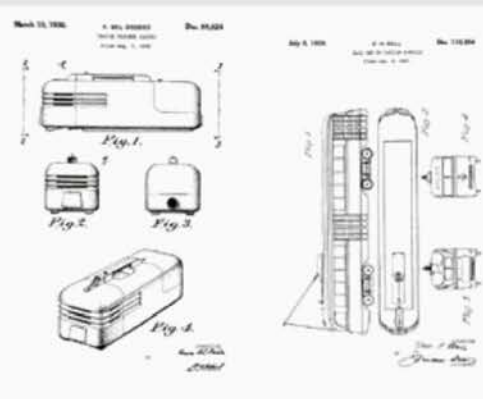

ВЕЩИ







June 4, 1935.

H. B. GARDNER ET AL.
MICHIGAN PATENT
FIG. 10. 10. 100

Des. 19,417

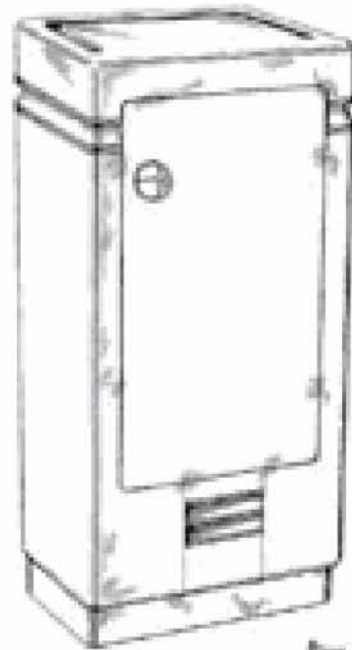

H. B. GARDNER
DESIGNER
ATTORNEY

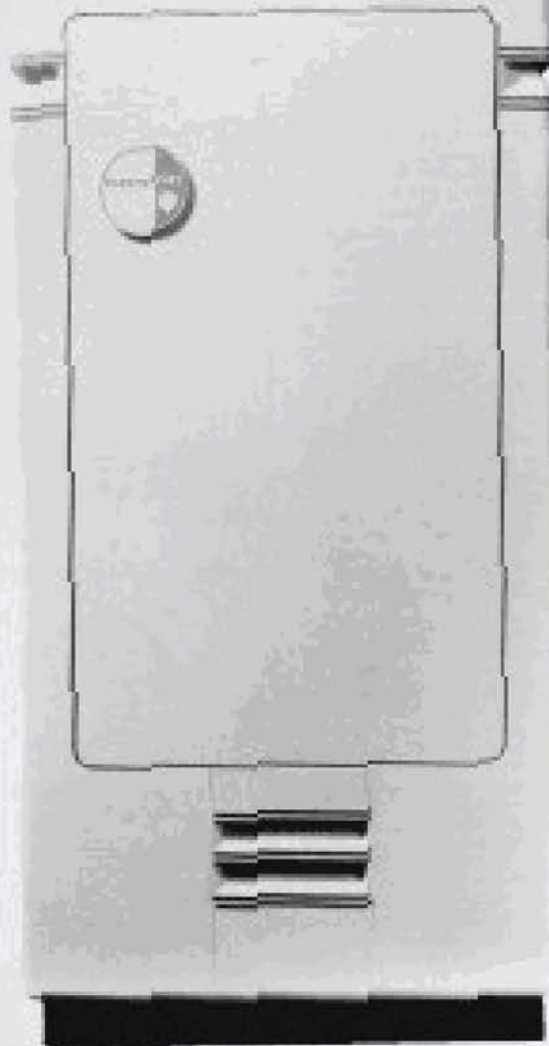

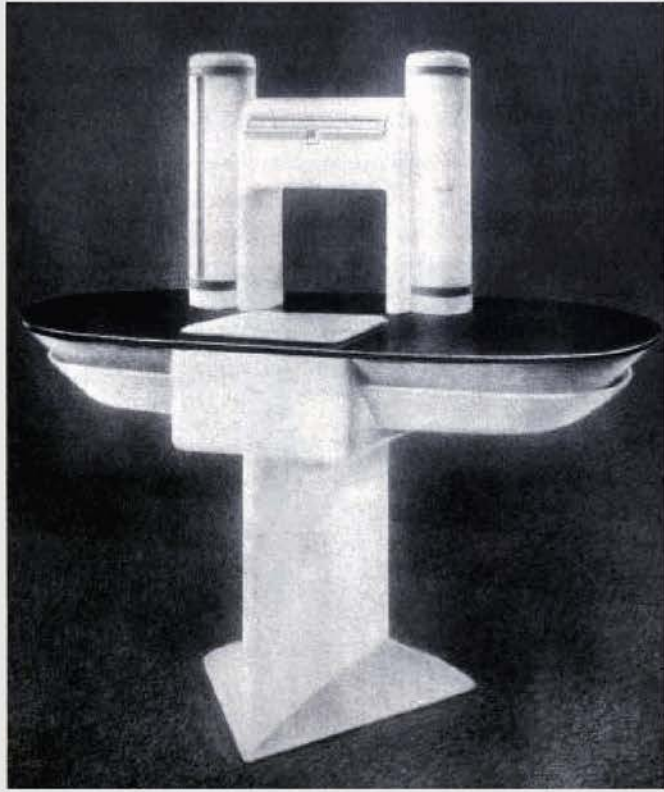

МЕБЕЛЬ



ROPER

Every Roper Gas Range is
inspected by a woman



before it is certified by the Roper
quality mark—the Roper purple line.





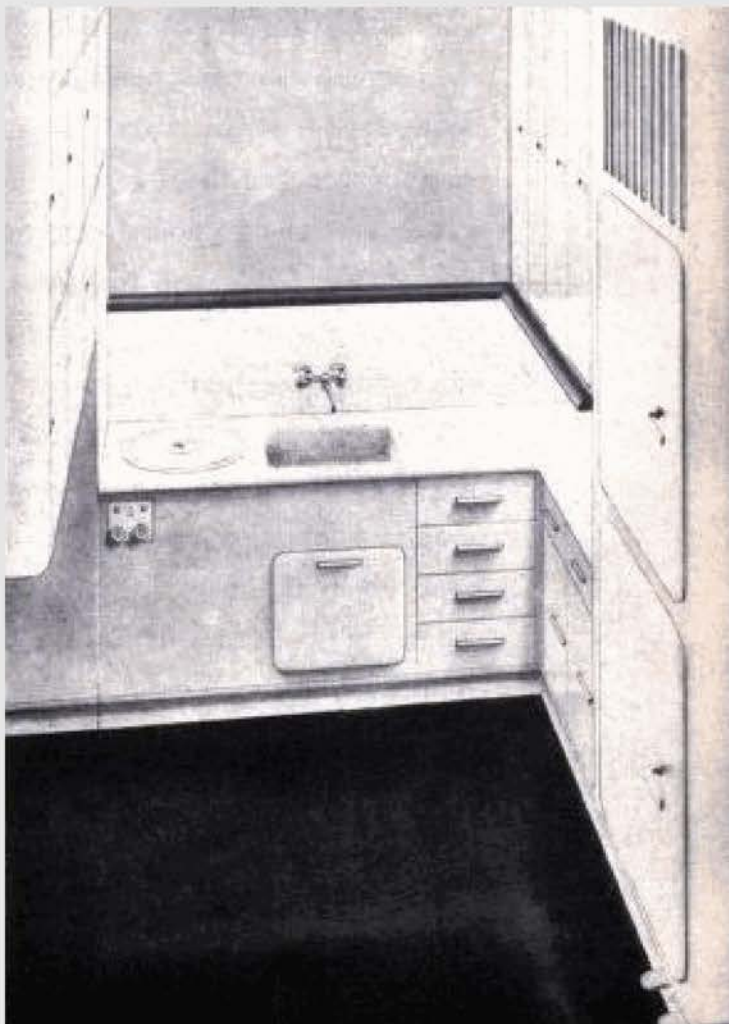

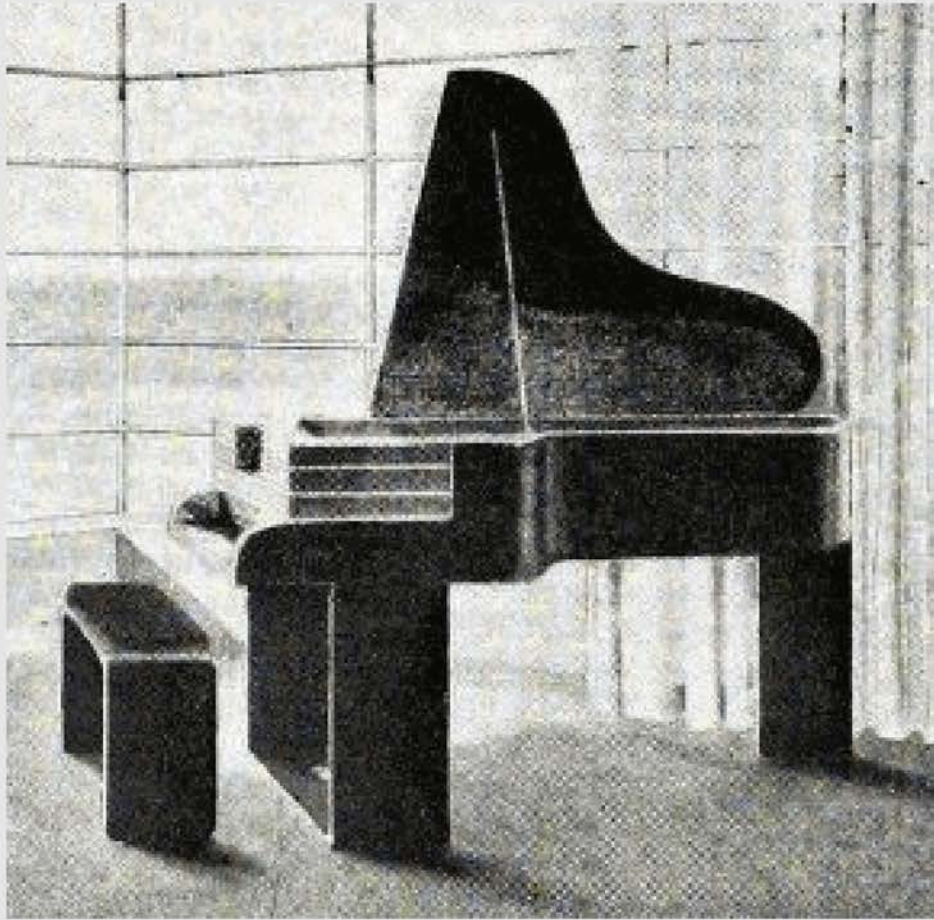

































ГРАФИКА





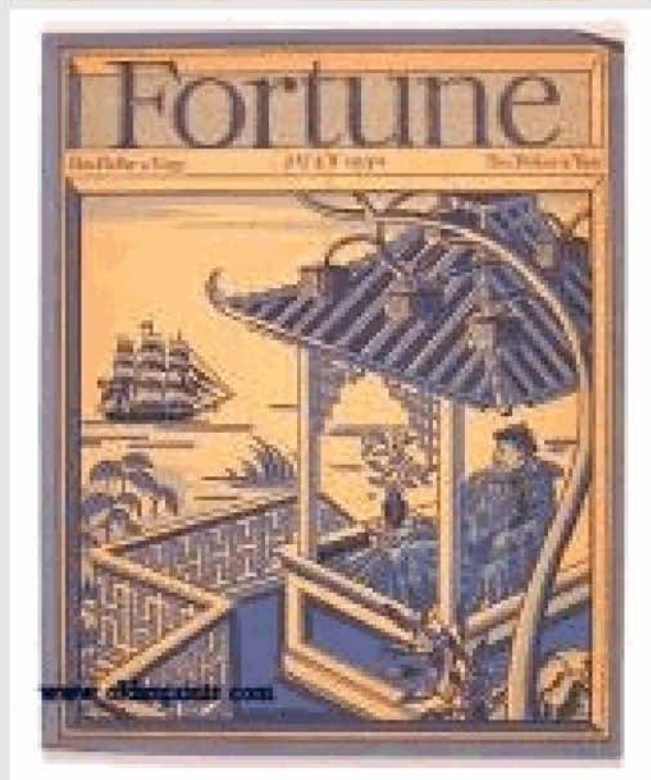

СКУЛЬПТУРА







КНИГИ

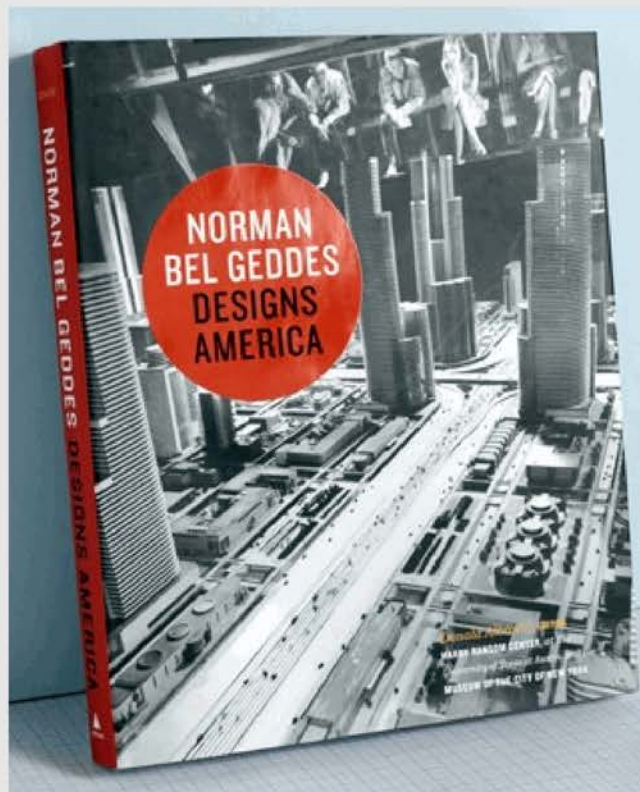

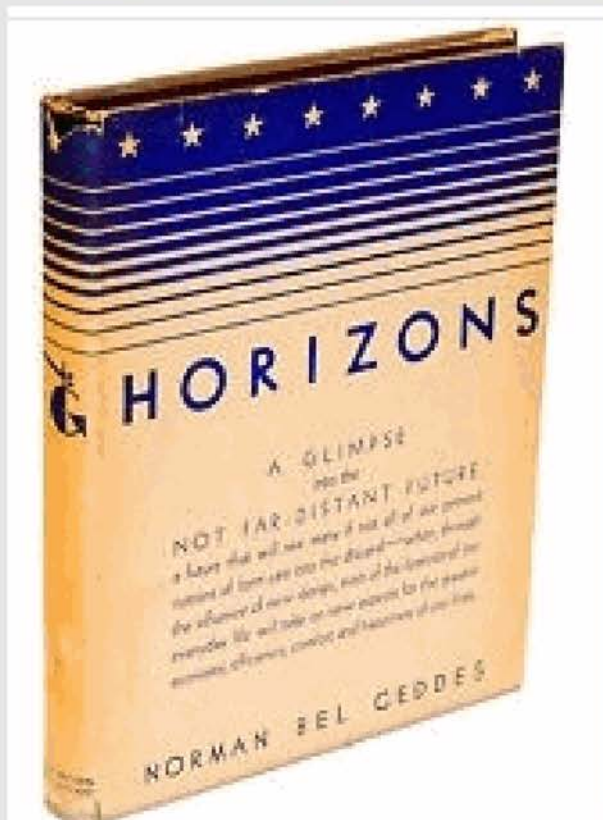
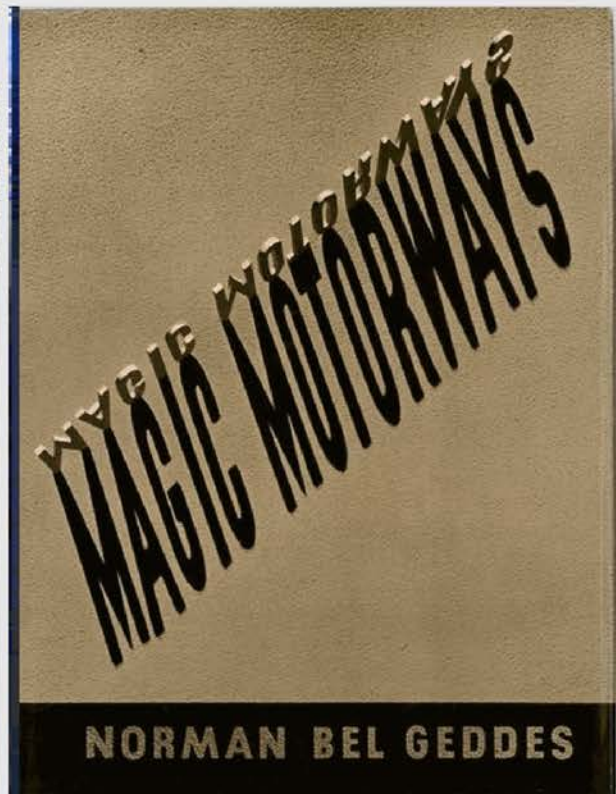
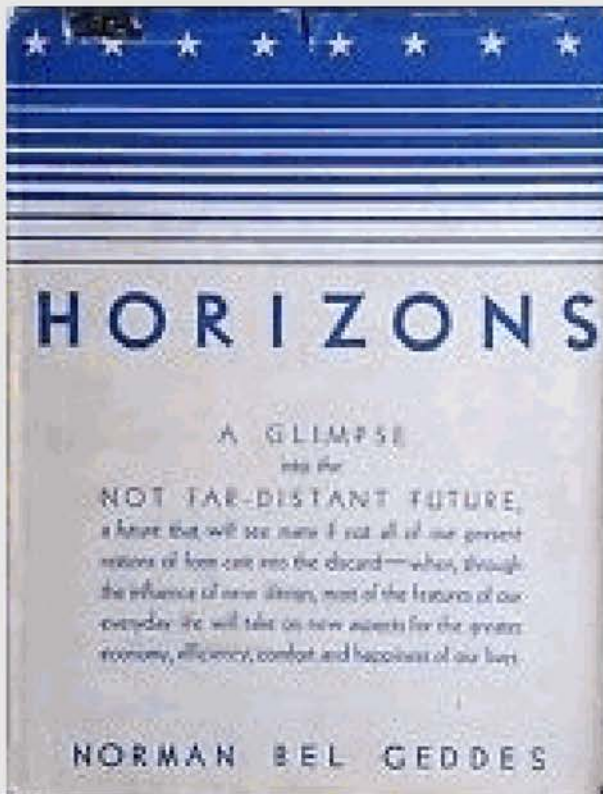

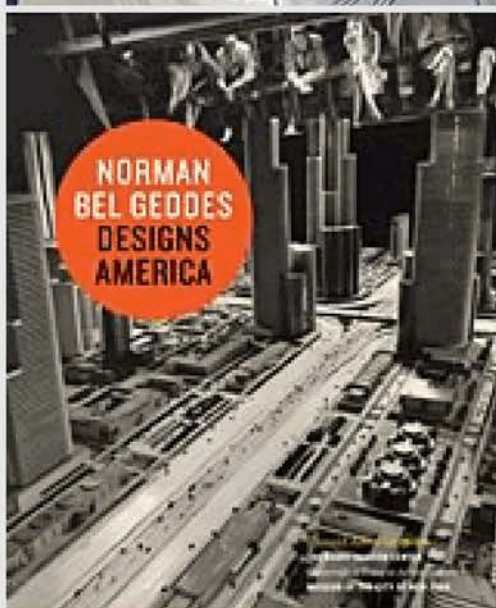
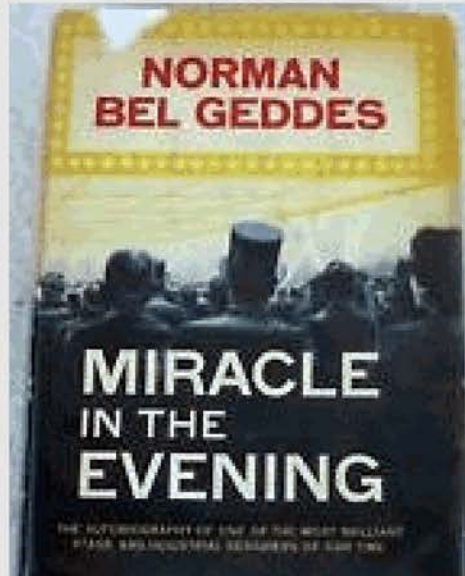
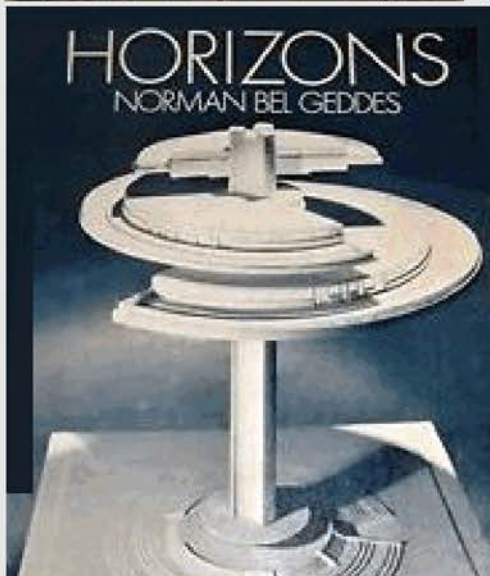
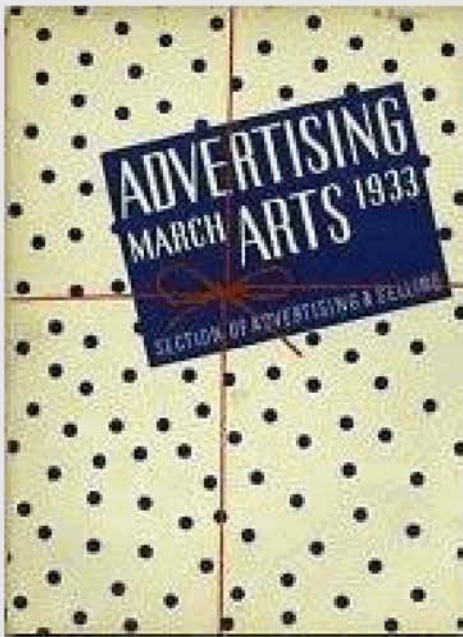

TEATP





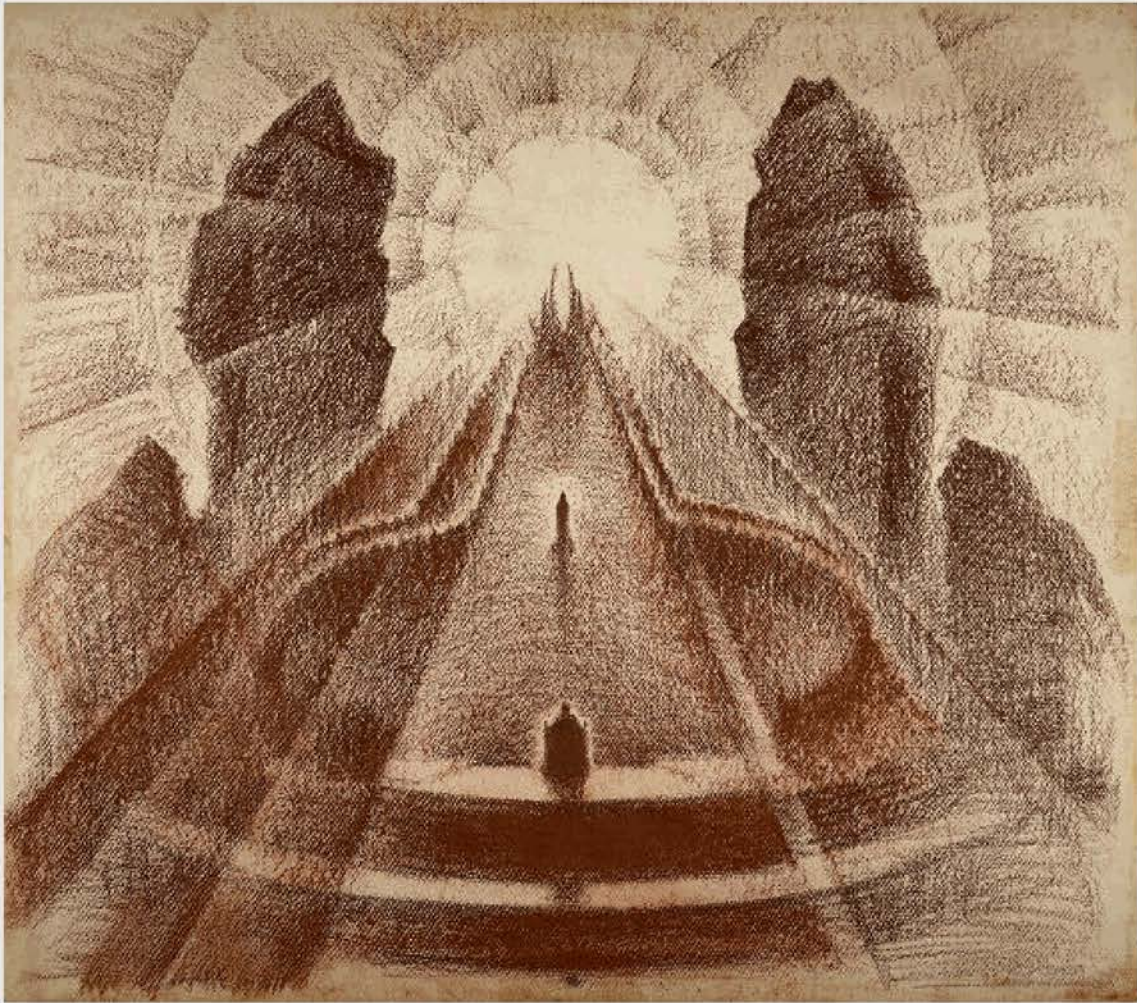







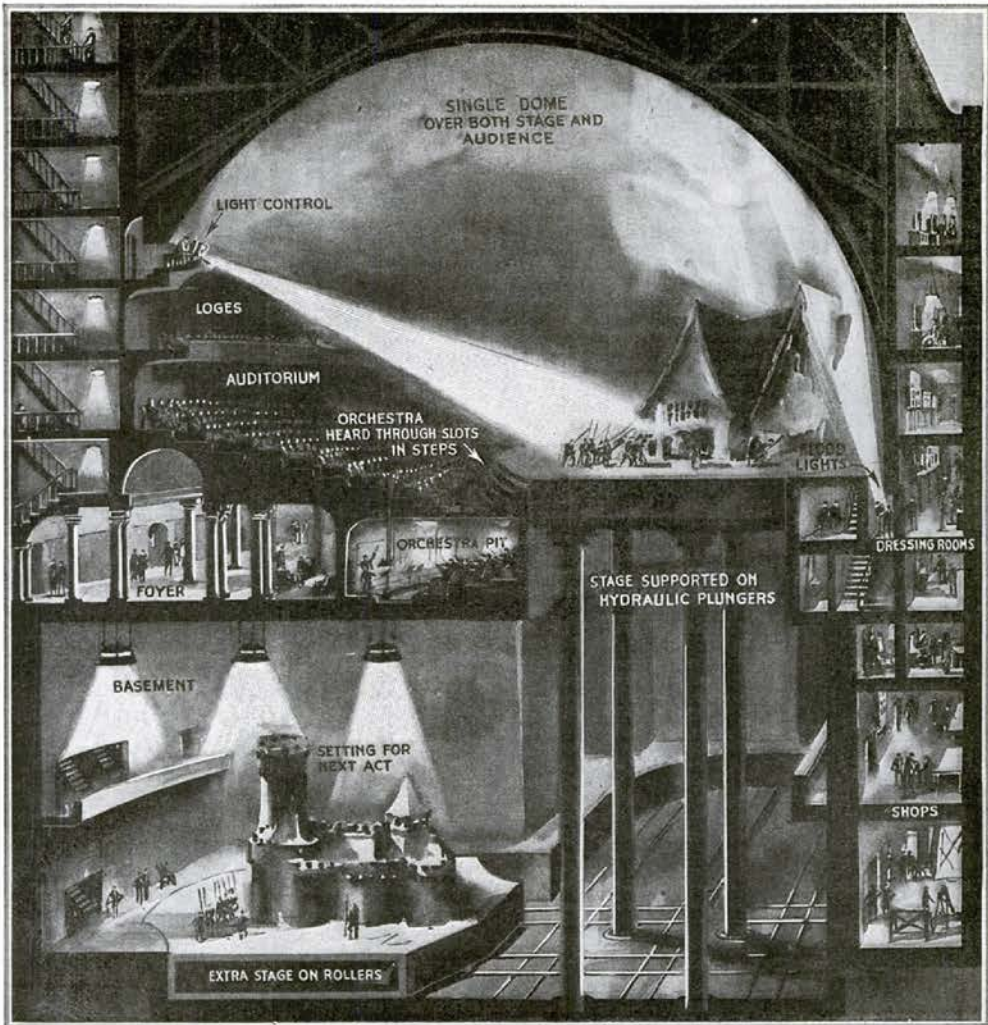
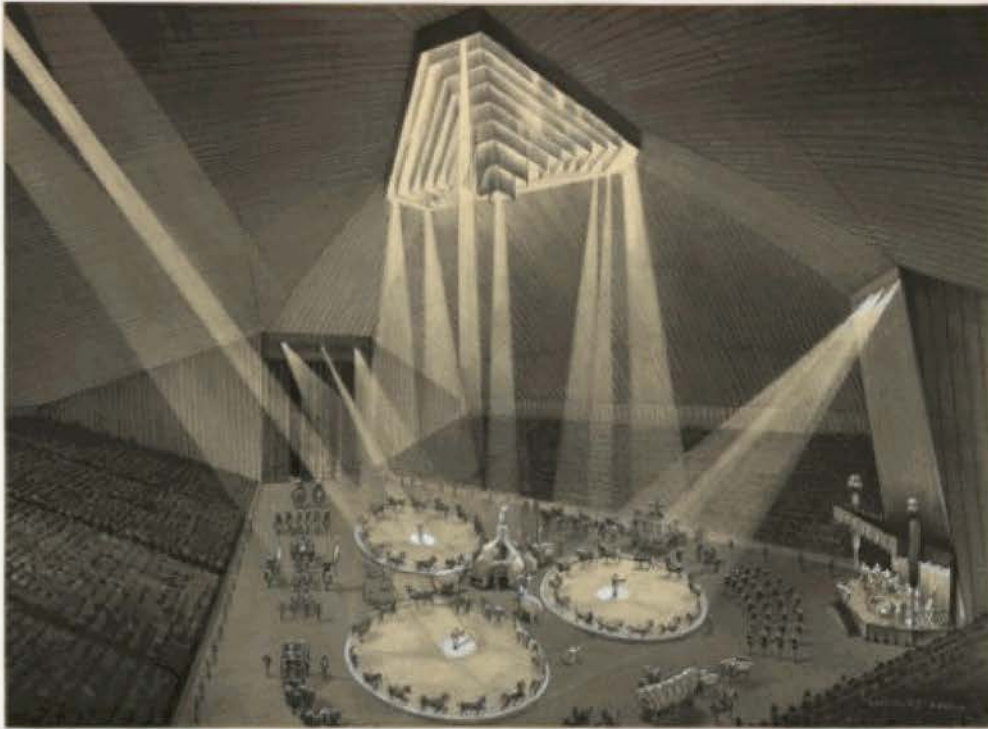







F. Ray Comstock and Morris Gest
 Present for the first time to America,
 The Stupendous Spectacular
 Pantomime
The MIRACLES
 Staged by Max Reinhardt.
 Book by Karl Vollmoeller.
 Score by Engelbert Humperdinck.
 Revised and Extended by
 Friedrich Schirmer.
 Production Designed by
 Norman-Bel Geddes.
 Built by F.J. Casey & Co.

Entire Production under
 the Personal Supervision
 Morris Gest.

Presented Under License of Spectaculars
 Oliver M. Bayler
 Copyright, 1926 by Morris Gest.

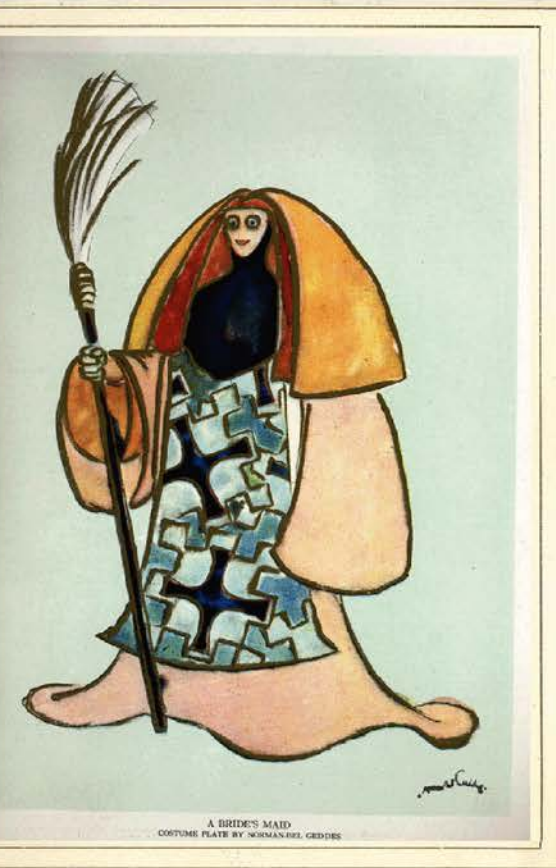
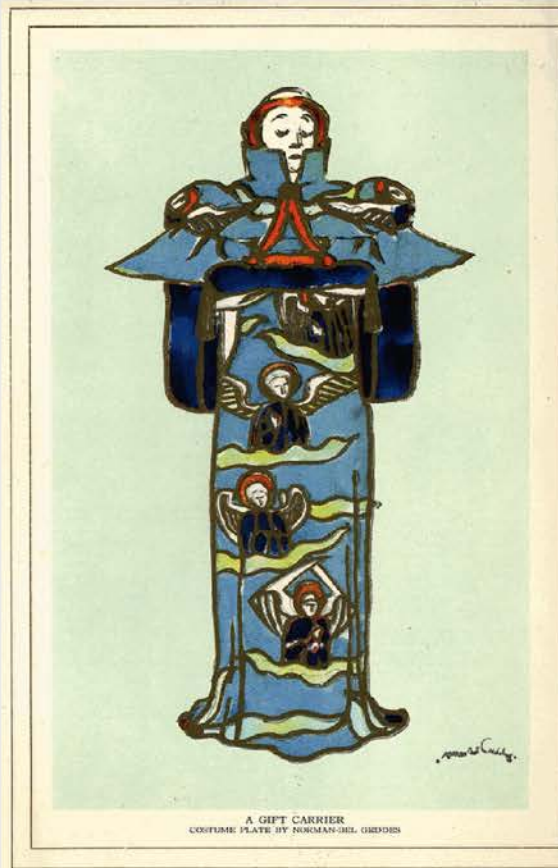

LIFE



WARM FOR WINTER

NOVEMBER 16, 1942 **10** CENTS
YEARLY SUBSCRIPTION \$4.50

REG. U. S. PAT. OFF.

ФОТОАЛЬБОМ















Н.Н. Александров

НОРМАН БЕЛ ГЕДДЕС

Альбом

